



# User's Manual

## Model 325

### Temperature Controller



Lake Shore Cryotronics, Inc.  
575 McCorkle Blvd.  
Westerville, Ohio 43082-8888 USA

E-mail addresses:

[sales@lakeshore.com](mailto:sales@lakeshore.com)  
[service@lakeshore.com](mailto:service@lakeshore.com)

Visit our website at:

[www.lakeshore.com](http://www.lakeshore.com)

Fax: (614) 891-1392

Telephone: (614) 891-2243

Methods and apparatus disclosed and described herein have been developed solely on company funds of Lake Shore Cryotronics, Inc. No government or other contractual support or relationship whatsoever has existed which in any way affects or mitigates proprietary rights of Lake Shore Cryotronics, Inc. in these developments. Methods and apparatus disclosed herein may be subject to U.S. Patents existing or applied for. Lake Shore Cryotronics, Inc. reserves the right to add, improve, modify, or withdraw functions, design modifications, or products at any time without notice. Lake Shore shall not be liable for errors contained herein or for incidental or consequential damages in connection with furnishing, performance, or use of this material.

### LIMITED WARRANTY STATEMENT

#### WARRANTY PERIOD: ONE (1) YEAR

1. Lake Shore warrants that this Lake Shore product (the "Product") will be free from defects in materials and workmanship for the Warranty Period specified above (the "Warranty Period"). If Lake Shore receives notice of any such defects during the Warranty Period and the Product is shipped freight prepaid, Lake Shore will, at its option, either repair or replace the Product if it is so defective without charge to the owner for parts, service labor or associated customary return shipping cost. Any such replacement for the Product may be either new or equivalent in performance to new. Replacement or repaired parts will be warranted for only the unexpired portion of the original warranty or 90 days (whichever is greater).
2. Lake Shore warrants the Product only if it has been sold by an authorized Lake Shore employee, sales representative, dealer or original equipment manufacturer (OEM).
3. The Product may contain remanufactured parts equivalent to new in performance or may have been subject to incidental use.
4. The Warranty Period begins on the date of delivery of the Product or later on the date of installation of the Product if the Product is installed by Lake Shore, provided that if you schedule or delay the Lake Shore installation for more than 30 days after delivery the Warranty Period begins on the 31st day after delivery.
5. This limited warranty does not apply to defects in the Product resulting from (a) improper or inadequate maintenance, repair or calibration, (b) fuses, software and non-rechargeable batteries, (c) software, interfacing, parts or other supplies not furnished by Lake Shore, (d) unauthorized modification or misuse, (e) operation outside of the published specifications or (f) improper site preparation or maintenance.
6. TO THE EXTENT ALLOWED BY APPLICABLE LAW, THE ABOVE WARRANTIES ARE EXCLUSIVE AND NO OTHER WARRANTY OR CONDITION, WHETHER WRITTEN OR ORAL, IS EXPRESSED OR IMPLIED. LAKE SHORE SPECIFICALLY DISCLAIMS ANY IMPLIED WARRANTIES OR CONDITIONS OF MERCHANTABILITY, SATISFACTORY QUALITY AND/OR FITNESS FOR A PARTICULAR PURPOSE WITH RESPECT TO THE PRODUCT. Some countries, states or provinces do not allow limitations on an implied warranty, so the above limitation or exclusion might not apply to you. This warranty gives you specific legal rights and you might also have other rights that vary from country to country, state to state or province to province.
7. TO THE EXTENT ALLOWED BY APPLICABLE LAW, THE REMEDIES IN THIS WARRANTY STATEMENT ARE YOUR SOLE AND EXCLUSIVE REMEDIES.
8. EXCEPT TO THE EXTENT PROHIBITED BY APPLICABLE LAW, IN NO EVENT WILL LAKE SHORE OR ANY OF ITS SUBSIDIARIES, AFFILIATES OR SUPPLIERS BE LIABLE FOR DIRECT, SPECIAL, INCIDENTAL, CONSEQUENTIAL OR OTHER DAMAGES (INCLUDING LOST PROFIT, LOST DATA OR DOWNTIME COSTS) ARISING OUT OF THE USE, INABILITY TO USE OR RESULT OF USE OF THE PRODUCT, WHETHER BASED IN WARRANTY, CONTRACT, TORT OR OTHER LEGAL THEORY, AND WHETHER OR NOT LAKE SHORE HAS BEEN ADVISED OF THE POSSIBILITY OF SUCH DAMAGES. Your use of the Product is entirely at your own risk. Some countries, states and provinces do not allow the exclusion of liability for incidental or consequential damages, so the above limitation may not apply to you.

### LIMITED WARRANTY STATEMENT (Continued)

9. EXCEPT TO THE EXTENT ALLOWED BY APPLICABLE LAW, THE TERMS OF THIS LIMITED WARRANTY STATEMENT DO NOT EXCLUDE, RESTRICT OR MODIFY, AND ARE IN ADDITION TO, THE MANDATORY STATUTORY RIGHTS APPLICABLE TO THE SALE OF THE PRODUCT TO YOU.

### CERTIFICATION

Lake Shore certifies that this product has been inspected and tested in accordance with its published specifications and that this product met its published specifications at the time of shipment. The accuracy and calibration of this product at the time of shipment are traceable to the United States National Institute of Standards and Technology (NIST); formerly known as the National Bureau of Standards (NBS).

### FIRMWARE LIMITATIONS

Lake Shore has worked to ensure that the Model 325 firmware is as free of errors as possible, and that the results you obtain from the instrument are accurate and reliable. However, as with any computer-based software, the possibility of errors exists.

In any important research, as when using any laboratory equipment, results should be carefully examined and rechecked before final conclusions are drawn. Neither Lake Shore nor anyone else involved in the creation or production of this firmware can pay for loss of time, inconvenience, loss of use of the product, or property damage caused by this product or its failure to work, or any other incidental or consequential damages. Use of our product implies that you understand the Lake Shore license agreement and statement of limited warranty.

### FIRMWARE LICENSE AGREEMENT

The firmware in this instrument is protected by United States copyright law and international treaty provisions. To maintain the warranty, the code contained in the firmware must not be modified. Any changes made to the code is at the user's risk. Lake Shore will assume no responsibility for damage or errors incurred as result of any changes made to the firmware.

Under the terms of this agreement you may only use the Model 325 firmware as physically installed in the instrument. Archival copies are strictly forbidden. You may not decompile, disassemble, or reverse engineer the firmware. If you suspect there are problems with the firmware, return the instrument to Lake Shore for repair under the terms of the Limited Warranty specified above. Any unauthorized duplication or use of the Model 325 firmware in whole or in part, in print, or in any other storage and retrieval system is forbidden.

### TRADEMARK ACKNOWLEDGMENT

Many manufacturers and sellers claim designations used to distinguish their products as trademarks. Where those designations appear in this manual and Lake Shore was aware of a trademark claim, they appear with initial capital letters and the <sup>TM</sup> or <sup>®</sup> symbol.

Alumel<sup>TM</sup> and Chromel<sup>TM</sup> are trademarks of Concept Alloys, LLC.

Apiezon<sup>®</sup> is a trademark of M&I Materials, Ltd.

CalCurve<sup>TM</sup>, Cernox<sup>TM</sup>, Duo-Twist<sup>TM</sup>, Quad-Lead<sup>TM</sup>, Quad-Twist<sup>TM</sup>,

Rox<sup>TM</sup>, and SoftCal<sup>TM</sup> are trademarks of Lake Shore Cryotronics, Inc.

Cryogloves<sup>®</sup> is a trademark of Tempshield.

LabVIEW<sup>TM</sup> and NI-488.2<sup>TM</sup> are trademarks of National Instruments.

MS-DOS<sup>®</sup> and Windows<sup>®</sup> are trademarks of Microsoft Corp.

PC, XT, AT, and PS-2 are trademarks of IBM.

Stycast<sup>®</sup> is a trademark of Emerson & Cummings.

Copyright © 2006–2011 by Lake Shore Cryotronics, Inc. All rights reserved. No portion of this manual may be reproduced, stored in a retrieval system, or transmitted, in any form or by any means, electronic, mechanical, photocopying, recording, or otherwise, without the express written permission of Lake Shore.



## DECLARATION OF CONFORMITY

We: **Lake Shore Cryotronics, Inc.**  
**575 McCorkle Blvd.**  
**Westerville OH 43082-8888 USA**

hereby declare that the equipment specified conforms to the following Directives and Standards:

Application of Council Directives:..... **73/23/EEC**  
**89/336/EEC**

Standards to which Conformity is declared: ..... **EN61010-1:2001**  
**Overvoltage II**  
**Pollution Degree 2**  
**EN61326 A2:2001**  
**Class A**  
**Annex B**

Model Number: ..... **325**

**Ed Maloof**  
*Printed Name*

**Vice President of Engineering**  
*Position*

### **Electromagnetic Compatibility (EMC) for the Model 325 Temperature Controller**

Electromagnetic Compatibility (EMC) of electronic equipment is a growing concern worldwide. Emissions of and immunity to electromagnetic interference is now part of the design and manufacture of most electronics. To qualify for the CE Mark, the Model 325 meets or exceeds the requirements of the European EMC Directive 89/336/EEC as a **CLASS A** product. A Class A product is allowed to radiate more RF than a Class B product and must include the following warning:

**WARNING:** This is a Class A product. In a domestic environment, this product may cause radio interference in which case the user may be required to take adequate measures.

The instrument was tested under normal operating conditions with sensor and interface cables attached. If the installation and operating instructions in the User's Manual are followed, there should be no degradation in EMC performance.

This instrument is not intended for use in close proximity to RF Transmitters such as two-way radios and cell phones. Exposure to RF interference greater than that found in a typical laboratory environment may disturb the sensitive measurement circuitry of the instrument.

Pay special attention to instrument cabling. Improperly installed cabling may defeat even the best EMC protection. For the best performance from any precision instrument, follow the grounding and shielding instructions in the User's Manual. In addition, the installer of the Model 325 should consider the following:

- Shield measurement and computer interface cables.
- Leave no unused or unterminated cables attached to the instrument.
- Make cable runs as short and direct as possible. Higher radiated emissions is possible with long cables.
- Do not tightly bundle cables that carry different types of signals.

# TABLE OF CONTENTS

<i>Chapter/Section</i>	<i>Title</i>	<i>Page</i>
<b>1</b>	<b>INTRODUCTION .....</b>	<b>1-1</b>
1.0	PRODUCT DESCRIPTION .....	1-1
1.1	SENSOR SELECTION .....	1-4
1.2	SPECIFICATIONS.....	1-6
1.3	SAFETY SUMMARY .....	1-8
1.4	SAFETY SYMBOLS .....	1-9
<b>2</b>	<b>COOLING SYSTEM DESIGN.....</b>	<b>2-1</b>
2.0	GENERAL .....	2-1
2.1	TEMPERATURE SENSOR SELECTION .....	2-1
2.1.1	Temperature Range.....	2-1
2.1.2	Sensor Sensitivity .....	2-1
2.1.3	Environmental Conditions .....	2-1
2.1.4	Measurement Accuracy .....	2-2
2.1.5	Sensor Package.....	2-2
2.2	CALIBRATED SENSORS .....	2-2
2.2.1	Traditional Calibration .....	2-2
2.2.2	SoftCal™ .....	2-2
2.2.3	Standard Curves .....	2-3
2.2.4	CalCurve™ .....	2-4
2.3	SENSOR INSTALLATION.....	2-4
2.3.1	Mounting Materials.....	2-4
2.3.2	Sensor Location .....	2-4
2.3.3	Thermal Conductivity .....	2-4
2.3.4	Contact Area .....	2-4
2.3.5	Contact Pressure .....	2-5
2.3.6	Lead Wire.....	2-5
2.3.7	Lead Soldering.....	2-6
2.3.8	Heat Sinking Leads.....	2-6
2.3.9	Thermal Radiation.....	2-6
2.4	HEATER SELECTION AND INSTALLATION.....	2-6
2.4.1	Heater Resistance and Power .....	2-6
2.4.2	Heater Location.....	2-7
2.4.3	Heater Types .....	2-7
2.4.4	Heater Wiring .....	2-7
2.5	CONSIDERATIONS FOR GOOD CONTROL .....	2-7
2.5.1	Thermal Conductivity .....	2-7
2.5.2	Thermal Lag.....	2-7
2.5.3	Two-Sensor Approach .....	2-7
2.5.4	Thermal Mass .....	2-8
2.5.5	System Nonlinearity .....	2-8
2.6	PID CONTROL .....	2-8
2.6.1	Proportional (P).....	2-8
2.6.2	Integral (I).....	2-9
2.6.3	Derivative (D) .....	2-9
2.6.4	Manual Heater Power (MHP) Output .....	2-9
2.7	MANUAL TUNING.....	2-11
2.7.1	Setting Heater Range .....	2-11
2.7.2	Tuning Proportional.....	2-11
2.7.3	Tuning Integral .....	2-12
2.7.4	Tuning Derivative .....	2-12
2.8	AUTOTUNING.....	2-12
2.9	ZONE TUNING.....	2-13

## TABLE OF CONTENTS (Continued)

<i>Chapter/Section</i>	<i>Title</i>	<i>Page</i>
<b>3</b>	<b>INSTALLATION</b>	<b>3-1</b>
3.0	GENERAL	3-1
3.1	INSPECTION AND UNPACKING	3-1
3.2	REAR PANEL DEFINITION	3-2
3.3	LINE INPUT ASSEMBLY	3-3
3.3.1	Line Voltage	3-3
3.3.2	Line Fuse and Fuse Holder	3-3
3.3.3	Power Cord	3-3
3.3.4	Power Switch	3-3
3.4	DIODE/RESISTOR SENSOR INPUTS	3-4
3.4.1	Sensor Input Connector and Pinout	3-4
3.4.2	Sensor Lead Cable	3-4
3.4.3	Grounding and Shielding Sensor Leads	3-5
3.4.4	Sensor Polarity	3-5
3.4.5	Four-Lead Sensor Measurement	3-5
3.4.6	Two-Lead Sensor Measurement	3-5
3.4.7	Lowering Measurement Noise	3-6
3.5	THERMOCOUPLE SENSOR INPUTS	3-6
3.5.1	Sensor Input Terminals	3-6
3.5.2	Thermocouple Installation	3-7
3.5.3	Grounding and Shielding	3-7
3.6	HEATER OUTPUT SETUP	3-7
3.6.1	Loop 1 Output	3-7
3.6.2	Loop 1 Heater Output Connector	3-7
3.6.3	Loop 1 Heater Output Wiring	3-7
3.6.4	Loop 1 Heater Output Noise	3-8
3.6.5	Loop 2 Output	3-8
3.6.6	Loop 2 Output Resistance	3-8
3.6.7	Loop 2 Output Connector	3-8
3.6.8	Loop 2 Heater Protection	3-8
3.6.9	Boosting the Output Power	3-8
3.7	INITIAL SETUP AND SYSTEM CHECKOUT PROCEDURE	3-9
<b>4</b>	<b>OPERATION</b>	<b>4-1</b>
4.0	GENERAL	4-1
4.1	FRONT PANEL DESCRIPTION	4-1
4.1.1	Keypad Definitions	4-1
4.1.2	Annunciators	4-2
4.1.3	General Keypad Operation	4-2
4.1.4	Display Definition	4-3
4.2	TURNING POWER ON	4-4
4.3	DISPLAY FORMAT AND SOURCE (UNITS) SELECTION	4-4
4.4	INPUT SETUP	4-6
4.4.1	Diode Sensor Input Setup – 10 $\mu$ A Excitation Current	4-6
4.4.2	Diode Sensor Input Setup – 1 mA Excitation Current	4-6
4.4.3	Resistor Sensor Input Setup	4-7
4.4.3.1	Thermal EMF Compensation	4-8
4.4.4	Thermocouple Sensor Input Setup	4-8
4.4.4.1	Room-Temperature Compensation	4-9
4.4.4.2	Room-Temperature Calibration Procedure	4-9
4.4.5	Temperature Limit (For Firmware Version 1.5 and Later)	4-10
4.5	CURVE SELECTION	4-10
4.5.1	Diode Sensor Curve Selection	4-11
4.5.2	Resistor Sensor Curve Selection	4-12
4.5.3	Thermocouple Sensor Curve Selection	4-12
4.5.4	Filter	4-12

## TABLE OF CONTENTS (Continued)

<i>Chapter/Section</i>	<i>Title</i>	<i>Page</i>
4.6	TEMPERATURE CONTROL .....	4-13
4.6.1	Control Loops.....	4-13
4.6.2	Control Modes.....	4-14
4.6.3	Tuning Modes .....	4-14
4.7	CONTROL SETUP .....	4-15
4.8	MANUAL TUNING .....	4-16
4.8.1	Manually Setting Proportional (P) .....	4-16
4.8.2	Manually Setting Integral (I) .....	4-17
4.8.3	Manually Setting Derivative (D).....	4-17
4.8.4	Setting Manual Heater Power (MHP) Output .....	4-18
4.9	AUTOTUNE (Closed-Loop PID Control).....	4-18
4.10	ZONE SETTINGS (Closed-Loop Control Mode).....	4-19
4.11	SETPOINT.....	4-22
4.12	RAMP .....	4-23
4.13	HEATER RANGE AND HEATER OFF .....	4-24
4.14	HEATER RESISTANCE SETTING.....	4-24
4.15	LOCKING AND UNLOCKING THE KEYPAD .....	4-25
4.16	REMOTE/LOCAL .....	4-25
4.17	INTERFACE .....	4-25
4.18	DEFAULT VALUES .....	4-26
<b>5</b>	<b>ADVANCED OPERATION .....</b>	<b>5-1</b>
5.0	GENERAL .....	5-1
5.1	CURVE NUMBERS AND STORAGE .....	5-1
5.1.1	Curve Header Parameters .....	5-1
5.1.2	Curve Breakpoints .....	5-1
5.2	FRONT PANEL CURVE ENTRY OPERATIONS .....	5-3
5.2.1	Edit Curve .....	5-3
5.2.1.1	Thermocouple Curve Considerations .....	5-5
5.2.2	Erase Curve .....	5-5
5.2.3	Copy Curve .....	5-6
5.3	SOFTCAL™ .....	5-6
5.3.1	SoftCal With Silicon Diode Sensors .....	5-7
5.3.2	SoftCal Accuracy With Silicon Diode Sensors .....	5-7
5.3.3	SoftCal With Platinum Sensors .....	5-8
5.3.4	SoftCal Accuracy With Platinum Sensors .....	5-8
5.3.5	SoftCal Calibration Curve Creation .....	5-9
<b>6</b>	<b>COMPUTER INTERFACE OPERATION.....</b>	<b>6-1</b>
6.0	GENERAL .....	6-1
6.1	IEEE-488 INTERFACE .....	6-1
6.1.1	IEEE-488 Interface Parameters .....	6-1
6.1.2	Remote/Local Operation .....	6-2
6.1.3	IEEE-488 Command Structure.....	6-2
6.1.3.1	Bus Control Commands .....	6-2
6.1.3.2	Common Commands .....	6-3
6.1.3.3	Device Specific Commands.....	6-3
6.1.3.4	Message Strings.....	6-3
6.1.4	Status System.....	6-3
6.1.4.1	Overview .....	6-3
6.1.4.2	Status Register Sets.....	6-6
6.1.4.3	Status Byte and Service Request (SRQ).....	6-7
6.1.5	IEEE Interface Example Programs .....	6-10
6.1.5.1	IEEE-488 Interface Board Installation for Visual Basic Program .....	6-10
6.1.5.2	Visual Basic IEEE-488 Interface Program Setup.....	6-10
6.1.5.3	Program Operation.....	6-14
6.1.6	Troubleshooting .....	6-14

## TABLE OF CONTENTS (Continued)

<i>Chapter/Section</i>	<i>Title</i>	<i>Page</i>
6.2	SERIAL INTERFACE OVERVIEW .....	6-15
6.2.1	Physical Connection.....	6-15
6.2.2	Hardware Support.....	6-15
6.2.3	Character Format .....	6-16
6.2.4	Message Strings .....	6-16
6.2.5	Message Flow Control .....	6-16
6.2.6	Changing Baud Rate.....	6-17
6.2.7	Serial Interface Example Program .....	6-17
6.2.7.1	Visual Basic Serial Interface Program Setup.....	6-17
6.2.7.2	Program Operation.....	6-20
6.2.8	Troubleshooting .....	6-20
6.3	COMMAND SUMMARY .....	6-21
6.3.1	Interface Commands (Alphabetical Listing).....	6-23
<b>7</b>	<b>OPTIONS AND ACCESSORIES .....</b>	<b>7-1</b>
7.0	GENERAL .....	7-1
7.1	MODELS .....	7-1
7.2	OPTIONS .....	7-1
7.3	ACCESSORIES.....	7-2
7.4	MODEL 3003 HEATER OUTPUT CONDITIONER.....	7-4
<b>8</b>	<b>SERVICE .....</b>	<b>8-1</b>
8.0	GENERAL .....	8-1
8.1	CONTACTING LAKE SHORE CRYOTRONICS.....	8-1
8.2	RETURNING PRODUCTS TO LAKE SHORE .....	8-1
8.3	FUSE DRAWER .....	8-2
8.4	LINE VOLTAGE SELECTION .....	8-2
8.5	FUSE REPLACEMENT .....	8-3
8.6	ELECTROSTATIC DISCHARGE.....	8-3
8.6.1	Identification of Electrostatic Discharge Sensitive Components.....	8-3
8.6.2	Handling Electrostatic Discharge Sensitive Components.....	8-3
8.7	REAR PANEL CONNECTOR DEFINITIONS .....	8-4
8.7.1	Serial Interface Cable Wiring .....	8-6
8.7.2	IEEE-488 Interface Connector .....	8-7
8.8	TOP OF ENCLOSURE REMOVE AND REPLACE PROCEDURE.....	8-8
8.9	FIRMWARE AND NOVDRAM REPLACEMENT .....	8-8
8.10	JUMPERS .....	8-9
8.11	ERROR MESSAGES.....	8-9
8.12	CALIBRATION PROCEDURE .....	8-11
8.12.1	Equipment Required for Calibration .....	8-11
8.12.2	Diode/Resistor Sensor Input Calibration .....	8-12
8.12.2.1	Sensor Input Calibration Setup and Serial Communication Verification .....	8-12
8.12.2.2	10 $\mu$ A Current Source Calibration and 1 mA Current Source Verification.....	8-12
8.12.2.3	Diode Input Ranges Calibration.....	8-13
8.12.2.4	Resistive Input Ranges Calibration.....	8-14
8.12.3	Diode Sensor Input Calibration – 1 mA Excitation Current.....	8-15
8.12.4	Thermocouple Sensor Input Calibration.....	8-15
8.12.4.1	Sensor Input Calibration Setup.....	8-15
8.12.4.2	Thermocouple Input Ranges Calibration .....	8-15
8.12.5	Loop 2 Heater Calibration .....	8-16
8.12.5.1	Loop 2 Voltage Output Calibration.....	8-16
8.12.6	Calibration Specific Interface Commands .....	8-17
<b>APPENDIX A – GLOSSARY OF TERMINOLOGY .....</b>		<b>A-1</b>
<b>APPENDIX B – TEMPERATURE SCALES.....</b>		<b>B-1</b>
<b>APPENDIX C – HANDLING OF LIQUID HELIUM AND NITROGEN .....</b>		<b>C-1</b>
<b>APPENDIX D – CURVE TABLES.....</b>		<b>D-1</b>



# LIST OF ILLUSTRATIONS

<i>Figure No.</i>	<i>Title</i>	<i>Page</i>
1-1	Model 325 Front View .....	1-1
1-2	Model 325 Rear Panel Connections.....	1-2
2-1	Silicon Diode Sensor Calibrations and CalCurve .....	2-3
2-2	Typical Sensor Installation In A Mechanical Refrigerator .....	2-5
2-3	Examples of PID Control .....	2-10
3-1	Model 325 Rear Panel.....	3-2
3-2	Line Input Assembly .....	3-3
3-3	Diode/Resistor Input Connector .....	3-4
3-4	Thermocouple Input Definition and Common Connector Polarities .....	3-6
4-1	Model 325 Front Panel .....	4-1
4-2	Display Definition.....	4-3
4-3	Display Format Definition .....	4-4
4-4	Record of Zone Settings.....	4-20
5-1	SoftCal Temperature Ranges for Silicon Diode Sensors.....	5-7
5-2	SoftCal Temperature Ranges for Platinum Sensors.....	5-8
6-1	Model 325 Status System .....	6-4
6-2	Standard Event Status Register .....	6-6
6-3	Operation Event Register .....	6-7
6-4	Status Byte Register and Service Request Enable Register .....	6-8
6-5	GPIB Setting Configuration .....	6-11
6-6	DEV 12 Device Template Configuration.....	6-11
7-1	Model 325 Sensor and Heater Cable Assembly.....	7-4
7-2	Model 3003 Heater Output Conditioner .....	7-4
7-3	Model RM-1/2 Rack-Mount Kit .....	7-5
7-4	Model RM-2 Dual Rack-Mount Kit.....	7-6
8-1	Fuse Drawer.....	8-2
8-2	Power Fuse Access.....	8-2
8-3	Sensor INPUT A and B Connector Details .....	8-4
8-4	HEATER OUTPUT Connector Details.....	8-4
8-5	RELAYS and ANALOG OUTPUT Terminal Block.....	8-5
8-6	RS-232 Connector Details.....	8-5
8-7	IEEE-488 Rear Panel Connector Details.....	8-7
8-8	Location of Internal Components .....	8-10
B-1	Temperature Scale Comparison .....	B-1
C-1	Typical Cryogenic Storage Dewar .....	C-1

# LIST OF TABLES

<i>Table No.</i>	<i>Title</i>	<i>Page</i>
1-1	Sensor Temperature Range .....	1-4
1-2	Typical Sensor Performance .....	1-5
4-1	Sensor Input Types .....	4-6
4-2	Sensor Curves.....	4-10
4-3	Comparison of Control Loops 1 and 2.....	4-13
4-4	Default Values .....	4-26
5-1	Curve Header Parameters.....	5-2
5-2	Recommended Curve Parameters .....	5-2
6-1	Binary Weighting of an 8-Bit Register.....	6-5
6-2	Register Clear Methods.....	6-5
6-3	Programming Example to Generate an SRQ .....	6-9
6-4	IEEE-488 Interface Program Control Properties.....	6-12
6-5	Visual Basic IEEE-488 Interface Program .....	6-13
6-6	Serial Interface Specifications .....	6-15
6-7	Serial Interface Program Control Properties.....	6-18
6-8	Visual Basic Serial Interface Program .....	6-19
6-9	Command Summary .....	6-22
8-1	Calibration Table for Diode Ranges .....	8-13
8-2	Calibration Table for Resistive Ranges .....	8-15
8-3	Calibration Table for Thermocouple Ranges.....	8-16
B-1	Temperature Conversion Table .....	B-2
C-1	Comparison of Liquid Helium and Liquid Nitrogen .....	C-1
D-1	DT-470 Silicon Diode Curve (Curve 10) .....	D-1
D-2	DT-670 Silicon Diode Curve .....	D-2
D-3	DT-500 Series Silicon Diode Curves .....	D-2
D-4	PT-100/-1000 Platinum RTD Curves.....	D-3
D-5	RX-102A Rox™ Curve .....	D-4
D-6	RX-202A Rox™ Curve .....	D-5
D-7	Type K Thermocouple Curve.....	D-6
D-8	Type E Thermocouple Curve.....	D-7
D-9	Type T Thermocouple Curve.....	D-8
D-10	Chromel-AuFe 0.03% Thermocouple Curve.....	D-9
D-11	Chromel-AuFe 0.07% Thermocouple Curve.....	D-10

# CHAPTER 1

## INTRODUCTION

### 1.0 PRODUCT DESCRIPTION

The Model 325 dual-channel temperature controller is capable of supporting nearly any diode, RTD, or thermocouple temperature sensor. Two independent PID control loops with heater outputs of 25 W and 2 W are configured to drive either a 50  $\Omega$  or 25  $\Omega$  load for optimal cryocooler control flexibility. Designed with ease of use, functionality, and value in mind, the Model 325 is ideal for general-purpose laboratory and industrial temperature measurement and control applications.

#### *Sensor Inputs*

The Model 325 temperature controller features two inputs with a high-resolution 24-bit analog-to-digital converter and separate current sources for each input. Constant current excitation allows temperature to be measured and controlled down to 2.0 K using appropriate Cernox™ RTDs or down to 1.4 K using silicon diodes. Thermocouples allow for temperature measurement and control above 1,500 K. Sensors are optically isolated from other instrument functions for quiet and repeatable sensor measurements. The Model 325 also uses current reversal to eliminate thermal EMF errors in resistance sensors. Sensor data from each input is updated up to ten times per second, with display outputs twice each second. Standard temperature response curves for silicon diodes, platinum RTDs, ruthenium oxide RTDs, and many thermocouples are included. Up to fifteen 200-point CalCurves® (for Lake Shore calibrated temperature sensors) or user curves can be stored into non-volatile memory. A built-in SoftCal® algorithm can be used to generate curves for silicon diodes and platinum RTDs for storage as user curves. The Lake Shore curve handler software program allows sensor curves to be easily loaded and manipulated.

Sensor inputs for the Model 325 are factory configured and compatible with either diodes/RTDs or thermocouple sensors. Your choice of two diode/RTD inputs, one diode/RTD input and one thermocouple input, or two thermocouple inputs must be specified at time of order and cannot be reconfigured in the field. Software selects appropriate excitation current and signal gain levels when the sensor type is entered via the instrument front panel.



325\_Front.bmp

**Figure 1-1. Model 325 Front View**

**Product Description (Continued)**

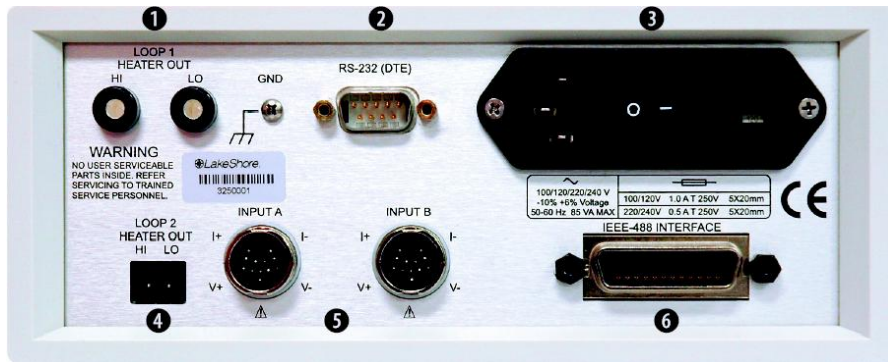
**Temperature Control**

The Model 325 temperature controller offers two independent proportional-integral-derivative (PID) control loops. A PID algorithm calculates control output based on temperature setpoint and feedback from the control sensor. Wide tuning parameters accommodate most cryogenic cooling systems and many small high-temperature ovens. A high-resolution digital-to-analog converter generates a smooth control output. The user can set the PID values or the AutoTuning feature of the Model 325 can automate the tuning process.

Control loop 1 heater output for the Model 325 is a well-regulated variable DC current source. The output can provide up to 25 W of continuous power to a 50 Ω or 25 Ω heater load, and includes a lower range for systems with less cooling power. Control loop 2 heater output is a single-range, variable DC voltage source. The output can source up to 0.2 A, providing 2 W of heater power at the 50 Ω setting or 1 W at the 25 Ω setting. When not being used for temperature control, the loop 2 heater output can be used as a manually controlled voltage source. The output voltage can vary from 0 to 10 V on the 50 Ω setting, or 0 to 5 V on the 25 Ω setting. Both heater outputs are referenced to chassis ground. The setpoint ramp feature allows smooth continuous setpoint changes and can also make the approach to setpoint more predictable. The zone feature can automatically change control parameter values for operation over a large temperature range. Ten different temperature zones can be loaded into the instrument, which will select the next appropriate value on setpoint change.

**Interface**

The Model 325 includes both parallel (IEEE-488) and serial (RS-232C) computer interfaces. In addition to data gathering, nearly every function of the instrument can be controlled via computer interface. Sensor curves can also be entered and manipulated through either interface using the Lake Shore curve handler software program.



- ❶ Loop 1 Heater output
- ❷ Serial (RS-232C) I/O (DTE)
- ❸ Line input assembly
- ❹ Loop 2 Heater output
- ❺ Sensor input connectors
- ❻ IEEE-488 interface

**Figure 1-2. Model 325 Rear Panel Connections**

**Configurable Display**

The Model 325 offers a bright, easy to read LCD display that simultaneously displays up to four readings. Display data includes input and source annunciators for each reading. All four display locations can be configured by the user. Data from either input can be assigned to any of the four locations, and the user's choice of temperature or sensor units can be displayed. Heater range and control output as current or power can be continuously displayed for immediate feedback on control operation. The channel A or B indicator is underlined to indicate which channel is being controlled by the displayed control loop.



**Normal (Default) Display Configuration**

The display provides four reading locations. Readings from each input and the control setpoint can be expressed in any combination of temperature or sensor units, with heater output expressed as a percent of full scale current or power.



**Flexible Configuration**

Reading locations can be configured by the user to meet application needs. The character preceding the reading indicates input A or B or setpoint S. The character following the reading indicates measurement units.



**Curve Entry**

The Model 325 display offers the flexibility to support curve, SoftCal™, and zone entry. Curve entry may be performed accurately and to full resolution via the display and keypad as well as computer interface.

## 1.1 SENSOR SELECTION

**Table 1-1. Sensor Temperature Range**

		<i>Model</i>	<i>Useful Range</i>	<i>Magnetic Field Use</i>
Diodes	Silicon Diode	DT-670-SD	1.4 K to 500 K	$T \geq 60 \text{ K} \ \& \ B \leq 3 \text{ T}$
	Silicon Diode	DT-670E-BR	30 K to 500 K	$T \geq 60 \text{ K} \ \& \ B \leq 3 \text{ T}$
	Silicon Diode	DT-414	1.4 K to 375 K	$T \geq 60 \text{ K} \ \& \ B \leq 3 \text{ T}$
	Silicon Diode	DT-421	1.4 K to 325 K	$T \geq 60 \text{ K} \ \& \ B \leq 3 \text{ T}$
	Silicon Diode	DT-470-SD	1.4 K to 500 K	$T \geq 60 \text{ K} \ \& \ B \leq 3 \text{ T}$
	Silicon Diode	DT-471-SD	10 K to 500 K	$T \geq 60 \text{ K} \ \& \ B \leq 3 \text{ T}$
	GaAlAs Diode	TG-120-P	1.4 K to 325 K	$T > 4.2 \text{ K} \ \& \ B \leq 5 \text{ T}$
	GaAlAs Diode	TG-120-PL	1.4 K to 325 K	$T > 4.2 \text{ K} \ \& \ B \leq 5 \text{ T}$
	GaAlAs Diode	TG-120-SD	1.4 K to 500 K	$T > 4.2 \text{ K} \ \& \ B \leq 5 \text{ T}$
Positive Temperature Coefficient (PTC) RTDs	100 $\Omega$ Platinum	PT-102/3	14 K to 873 K	$T > 40 \text{ K} \ \& \ B \leq 2.5 \text{ T}$
	100 $\Omega$ Platinum	PT-111	14 K to 673 K	$T > 40 \text{ K} \ \& \ B \leq 2.5 \text{ T}$
	Rhodium-Iron	RF-800-4	1.4 K to 500 K	$T > 77 \text{ K} \ \& \ B \leq 8 \text{ T}$
	Rhodium-Iron	RF-100T/U	1.4 K to 325 K	$T > 77 \text{ K} \ \& \ B \leq 8 \text{ T}$
Negative Temperature Coefficient (NTC) RTDs <sup>1</sup>	Cernox™	CX-1010	2 K to 325 K <sup>4</sup>	$T > 2 \ \& \ B \leq 19 \text{ T}$
	Cernox	CX-1030-HT	3.5 K to 420 K <sup>2,5</sup>	$T > 2 \ \& \ B \leq 19 \text{ T}$
	Cernox	CX-1050-HT	4 K to 420 K <sup>2,5</sup>	$T > 2 \ \& \ B \leq 19 \text{ T}$
	Cernox	CX-1070-HT	15 K to 420 K <sup>2</sup>	$T > 2 \ \& \ B \leq 19 \text{ T}$
	Cernox	CX-1080-HT	50 K to 420 K <sup>2</sup>	$T > 2 \ \& \ B \leq 19 \text{ T}$
	Germanium	GR-200A/B-1000	2.2 K to 100 K <sup>3</sup>	Not Recommended
	Germanium	GR-200A/B-1500	2.6 K to 100 K <sup>3</sup>	Not Recommended
	Germanium	GR-200A/B-2500	3.1 K to 100 K <sup>3</sup>	Not Recommended
	Carbon-Glass	CGR-1-500	4 K to 325 K <sup>4</sup>	$T > 2 \text{ K to } \leq 19 \text{ T}$
	Carbon-Glass	CGR-1-1000	5 K to 325 K <sup>4</sup>	$T > 2 \text{ K to } \leq 19 \text{ T}$
	Carbon-Glass	CGR-1-2000	6 K to 325 K <sup>4</sup>	$T > 2 \text{ K to } \leq 19 \text{ T}$
	Rox™	RX-102A	1.4 K to 40 K <sup>4</sup>	$T > 2 \text{ K to } \leq 10 \text{ T}$
	Thermocouples	Type K	9006-006	3.2 K to 1505 K
Type E		9006-004	3.2 K to 934 K	Not Recommended
Chromel-AuFe 0.07%		9006-002	1.2 K to 610 K	Not Recommended

<sup>1</sup> Single excitation current may limit the low temperature range of NTC resistors.

<sup>2</sup> Non-HT version maximum temperature: 325 K.

<sup>3</sup> Low temperature limited by input resistance range.

<sup>4</sup> Low temperature specified with self-heating error:  $\leq 5 \text{ mK}$ .

<sup>5</sup> Low temperature specified with self-heating error:  $\leq 12 \text{ mK}$ .

**Silicon diodes** are the best choice for general cryogenic use from 1.4 K to above room temperature. Diodes are economical to use because they follow a standard curve and are interchangeable in many applications. They are not suitable for use in ionizing radiation or magnetic fields.

**Cernox™** thin-film RTDs offer high sensitivity and low magnetic field-induced errors over the 2 K to 420 K temperature range. Cernox sensors require calibration.

**Platinum RTDs** offer high uniform sensitivity from 30 K to over 800 K. With excellent reproducibility, they are useful as thermometry standards. They follow a standard curve above 70 K and are interchangeable in many applications.

**Table 1-2. Typical Sensor Performance**

	<i>Example Lake Shore Sensor</i>	<i>Temp</i>	<i>Nominal Resistance/Voltage</i>	<i>Typical Sensor Sensitivity<sup>1</sup></i>	<i>Measurement Resolution: Temperature Equivalents</i>	<i>Electronic Accuracy: Temperature Equivalents</i>	<i>Temperature Accuracy including Electronic Accuracy, CalCurve™, and Calibrated Sensor</i>	<i>Electronic Control Stability<sup>2</sup>: Temperature Equivalents</i>
Silicon Diode	DT-670-SD-13 with 1.4H calibration	1.4 K	1.644 V	-12.49 mV/K	0.8 mK	±13 mK	±25 mK	±1.6 mK
		77 K	1.028 V	-1.73 mV/K	5.8 mK	±76 mK	±98 mK	±11.6 mK
		300 K	0.5597 V	-2.3 mV/K	4.4 mK	±47 mK	±79 mK	±8.8 mK
		500 K	0.0907 V	-2.12 mV/K	4.8 mK	±40 mK	±90 mK	±9.6 mK
Silicon Diode	DT-470-SD-13 with 1.4H calibration	1.4 K	1.6981 V	-13.1 mV/K	0.8 mK	±13 mK	±25 mK	±1.6 mK
		77 K	1.0203 V	-1.92 mV/K	5.2 mK	±69 mK	±91 mK	±10.4 mK
		300 K	0.5189 V	-2.4 mV/K	4.2 mK	±45 mK	±77 mK	±8.4 mK
		475 K	0.0906 V	-2.22 mV/K	4.6 mK	±39 mK	±89 mK	±9.2 mK
GaAlAs Diode	TG-120-SD with 1.4H calibration	1.4 K	5.391 V	-97.5 mV/K	0.2 mK	±7 mK	±19 mK	±0.4 mK
		77 K	1.422 V	-1.24 mV/K	16.2 mK	±180 mK	±202 mK	±32.4 mK
		300 K	0.8978 V	-2.85 mV/K	7 mK	±60 mK	±92 mK	±14 mK
		475 K	0.3778 V	-3.15 mV/K	6.4 mK	±38 mK	±88 mK	±12.8 mK
100 Ω Platinum RTD 500 Ω Full Scale	PT-103 with 1.4J calibration	30 K	3.660 Ω	0.191 Ω/K	10.5 mK	±23 mK	±33 mK	±21 mK
		77 K	20.38 Ω	0.423 Ω/K	4.8 mK	±15 mK	±27 mK	±9.6 mK
		300 K	110.35 Ω	0.387 Ω/K	5.2 mK	±39 mK	±62 mK	±10.4 mK
		500 K	185.668 Ω	0.378 Ω/K	5.3 mK	±60 mK	±106 mK	±10.6 mK
Cemox™	CX-1050-SD-HT <sup>3</sup> with 4M calibration	4.2 K	3507.2 Ω	-1120.8 Ω/K	36 μK	±1.4 mK	±6.4 mK	±72 μK
		77 K	205.67 Ω	-2.4116 Ω/K	16.6 mK	±76 mK	±92 mK	±33.2 mK
		300 K	59.467 Ω	-0.1727 Ω/K	232 mK	±717 mK	±757 mK	±464 mK
		420 K	45.030 Ω	-0.0829 Ω/K	483 mK	±1.42 K	±1.49 K	±966 mK
Germanium	GR-200A-1000 with 1.4D calibration	2 K	6674 Ω	-9930 Ω/K	4 μK	±0.3 mK	±4.3 mK	±8 μK
		4.2 K	1054 Ω	-526 Ω/K	76 μK	±1 mK	±5 mK	±152 μK
		10 K	170.9 Ω	-38.4 Ω/K	1 mK	±4.4 mK	±9.4 mK	±2 mK
		100 K	2.257 Ω	-0.018 Ω/K	2.22 K	±5.61 K	±5.626 K	±4.44 K
Carbon-Glass	CGR-1-2000 with 4L calibration	4.2 K	2260 Ω	-2060 Ω/K	20 μK	±0.5 mK	±4.5 mK	±40 μK
		77 K	21.65 Ω	-0.157 Ω/K	255 mK	±692 mK	±717 mK	±510 mK
		300 K	11.99 Ω	-0.015 Ω/K	2.667 K	±7 K	±7.1 K	±5.344 K
Thermocouple 50mV	Type K	75 K	-5862.9 μV	15.6 μV/K	26 mK	±0.25 K <sup>4</sup>	Calibration not available from Lake Shore	±52 mK
		300 K	1075.3 μV	40.6 μV/K	10 mK	±0.038 K <sup>4</sup>		±20 mK
		600 K	13325 μV	41.7 μV/K	10 mK	±0.184 K <sup>4</sup>		±20 mK
		1505 K	49998.3 μV	36.006 μV/K	12 mK	±0.73 K <sup>4</sup>		±24 mK

<sup>1</sup> Typical sensor sensitivities were taken from representative calibrations for the sensor listed.

<sup>2</sup> Control stability of the electronics only, in an ideal thermal system.

<sup>3</sup> Non-HT version maximum temperature: 325 K.

<sup>4</sup> Accuracy specification does not include errors from room temperature compensation.

## 1.2 SPECIFICATIONS

### Input Specifications

	Sensor Temperature Coefficient	Input Range	Excitation Current	Display Resolution	Measurement Resolution	Electronic Accuracy (at 25 °C)	Measurement Temperature Coefficient	Electronic Control Stability <sup>1</sup>
Diode	Negative	0 V to 2.5 V	10 $\mu$ A $\pm$ 0.05% <sup>2,3</sup>	100 $\mu$ V	0.4 $\mu$ V	$\pm$ 80 $\mu$ V $\pm$ 0.005% of rdg	(10 $\mu$ V + 0.0005% of rdg)/°C	$\pm$ 20 $\mu$ V
	Negative	0 V to 7.5 V	10 $\mu$ A $\pm$ 0.05% <sup>2,3</sup>	100 $\mu$ V	10 $\mu$ V	$\pm$ 80 $\mu$ V $\pm$ 0.01% of rdg	(20 $\mu$ V + 0.0005% of rdg)/°C	$\pm$ 40 $\mu$ V
PTC RTD	Positive	0 $\Omega$ to 500 $\Omega$	1 mA <sup>4</sup>	10 m $\Omega$	2 m $\Omega$	$\pm$ 0.004 $\Omega$ $\pm$ 0.01% of rdg	(0.2 m $\Omega$ + 0.0005% of rdg)/°C	$\pm$ 4 m $\Omega$
	Positive	0 $\Omega$ to 5000 $\Omega$	1 mA <sup>4</sup>	100 m $\Omega$	20 m $\Omega$	$\pm$ 0.04 $\Omega$ $\pm$ 0.02% of rdg	(0.2 m $\Omega$ + 0.0005% of rdg)/°C	$\pm$ 40 m $\Omega$
NTC RTD	Negative	0 $\Omega$ to 7500 $\Omega$	10 $\mu$ A $\pm$ 0.05%	100 m $\Omega$	40 m $\Omega$	$\pm$ 0.1 $\Omega$ $\pm$ 0.04% of rdg	(2 m $\Omega$ + 0.0005% of rdg)/°C	$\pm$ 80 m $\Omega$
Thermocouple	Positive	$\pm$ 25 mV	NA	1 $\mu$ V	0.4 $\mu$ V	$\pm$ 1 $\mu$ V $\pm$ 0.05% of rdg	(0.2 $\mu$ V + 0.0015% of rdg)/°C	$\pm$ 0.8 $\mu$ V
	Positive	$\pm$ 50 mV	NA	1 $\mu$ V	20 $\mu$ V	$\pm$ 1 $\mu$ V $\pm$ 0.05% of rdg	(0.2 $\mu$ V + 0.0015% of rdg)/°C	$\pm$ 0.8 $\mu$ V

<sup>1</sup> Control stability of the electronics only, in ideal thermal system

<sup>2</sup> Current source error has negligible effect on measurement accuracy

<sup>3</sup> Diode input excitation can be set to 1 mA

<sup>4</sup> Current source error is removed during calibration

<sup>5</sup> Accuracy specification does not include errors from room temperature compensation

### Thermometry

Number of inputs	2
Input configuration	Each input is factory configured for either diode / RTD or thermocouple
Isolation	Sensor inputs optically isolated from other circuits but not each other
A/D resolution	24-bit
Input accuracy	Sensor dependent, refer to Input Specifications table
Measurement resolution	Sensor dependent, refer to Input Specifications table
Max update rate:	10 rdg/s on each input, (except 5 rdg/s on input A when configured as thermocouple)
User curves	Room for 15, 200 point CalCurves™ or user curves
SoftCal™	Improves accuracy of DT-470 diode to $\pm$ 0.25 K from 30 K to 375 K. Improves accuracy of platinum RTDs to $\pm$ 0.25 K from 70 K to 325 K. Stored as user curves.
Filter	Averages 2 to 64 input readings

### Sensor Input Configuration

	Diode/RTD	Thermocouple
Measurement type	4-lead differential	2-lead, room temperature compensated
Excitation	Constant current with current reversal for RTDs	NA
Supported sensors	Diodes: Silicon, GaAlAs RTDs: 100 $\Omega$ Platinum, 1000 $\Omega$ Platinum, Germanium, Carbon-Glass, Cernox, and Rox	Most thermocouple types
Standard curves	DT-470, DT-500D, DT-670, PT-100, PT-1000, RX-102A, RX-202A	Type E, Type K, Type T, AuFe 0.07% vs. Cr, AuFe 0.03% vs Cr
Input connector	6-pin DIN	Ceramic isothermal block



## Specifications (Continued)

### Control

Control loops	2
Control type	Closed loop digital PID with manual heater output or open loop
Tuning	Autotune (one loop at a time), PID, PID zones
Control stability	Sensor dependent, refer to Input Specifications table
PID control settings:	
Proportional (Gain)	0 to 1000 with 0.1 setting resolution
Integral (Reset)	1 to 1000 (1000/s) with 0.1 setting resolution
Derivative (Rate)	1 to 200% with 1% resolution
Manual output	0 to 100% with 0.01% setting resolution
Zone control	10 temperature zones with P, I, D, manual heater out, and heater range
Setpoint ramping	0.1 K/min to 100 K/min

### Loop 1 Heater Output

Type	Variable DC current source	
D/A resolution	16-bit	
	25 $\Omega$ Setting	50 $\Omega$ Setting
Max power	25 W	25 W
Max current	1 A	0.71 A
Voltage compliance (min)	25 V	35.4 V
Heater load range	20 $\Omega$ to 25 $\Omega$	40 $\Omega$ to 50 $\Omega$
Heater load for max power	25 $\Omega$	50 $\Omega$
Ranges	2 (2.5 W/25 W)	
Heater noise (<1 kHz)	1 $\mu$ A + 0.01% of output	
Grounding	Output referenced to chassis ground	
Heater connector	Dual banana	
Safety limits	Curve temperature, power up heater off, short circuit protection	

### Loop 2 Heater Output

Type	Variable DC voltage source	
D/A resolution	16-bit	
	25 $\Omega$ Setting	50 $\Omega$ Setting
Max power	1 W	2 W
Max voltage	5 V	10 V
Current compliance (min)	0.2 A	0.2 A
Heater load range	$\geq$ 25 $\Omega$	$\geq$ 50 $\Omega$
Heater load for max power	25 $\Omega$	50 $\Omega$
Ranges	1	
Heater noise (<1 kHz)	50 $\mu$ V + 0.01% of output	
Grounding	Output referenced to chassis ground	
Heater connector	Detachable terminal block	
Safety limits	Curve temperature, power up heater off, short circuit protection	

### Front Panel

Display	2-line $\times$ 20-character liquid crystal display with 5.5 mm high characters
Number of reading displays	1 to 4
Display units	K, $^{\circ}$ C, V, mV, $\Omega$
Reading source	Temperature, sensor units
Display update rate	2 rdg/s
Temperature display resolution	0.001 $^{\circ}$ from 0 $^{\circ}$ to 99.999 $^{\circ}$ , 0.01 $^{\circ}$ from 100 $^{\circ}$ to 999.99 $^{\circ}$ , 0.1 $^{\circ}$ above 1000 $^{\circ}$
Sensor units display resolution	Sensor dependent, to 5 digits
Other displays	Setpoint, heater range and heater output (user selected)
Setpoint setting resolution	Same as display resolution (actual resolution is sensor dependent)
Heater output display	Numeric display in percent of full scale for power or current
Heater output resolution	1%
Display annunciators	Control Input, Remote, Autotune
Keypad	20-key membrane, numeric and specific functions
Front panel features	Front panel curve entry, keypad lock-out

**Specifications (Continued)****Interface**

IEEE-488.2 interface:

Features	SH1, AH1, T5, L4, SR1, RL1, PP0, DC1, DT0, C0, E1
Reading rate	To 10 rdg/s on each input
Software support	LabVIEW™ driver (contact Lake Shore for availability)

**Serial interface**

Electrical format	RS-232C
Baud rates	9600, 19200, 38400, 57600
Connector	9-pin D-style, DTE configuration
Reading rate	To 10 rdg/s on each input

**General**

Ambient temperature	15 °C to 35 °C at rated accuracy. 5 °C to 40 °C at reduced accuracy
Power requirement	100, 120, 220, 240 VAC, +6% –10%, 50 or 60 Hz, 85 VA
Size	216 mm W × 89 mm H × 368 mm D (8.5 in × 3.5 in × 14.5 in), half rack
Weight	4.0 kg (8.8 lb)
Approval	CE mark (contact Lake Shore for availability)

**Ordering Information**

Standard Temperature Controllers, all features included:

<i>Part Number</i>	<i>Description (Input configuration cannot be changed in the field)</i>
325	Two diode / RTD inputs
325-T1	One diode / RTD, one thermocouple input
325-T2	Two thermocouple inputs

Refer to Chapter 7 of this manual for a complete description of Model 325 options and accessories.

*Specifications subject to change without notice.***1.3 SAFETY SUMMARY**

Observe these general safety precautions during all phases of instrument operation, service, and repair. Failure to comply with these precautions or with specific warnings elsewhere in this manual violates safety standards of design, manufacture, and intended instrument use. Lake Shore Cryotronics, Inc. assumes no liability for Customer failure to comply with these requirements.

The Model 325 protects the operator and surrounding area from electric shock or burn, mechanical hazards, excessive temperature, and spread of fire from the instrument. Environmental conditions outside of the conditions below may pose a hazard to the operator and surrounding area.

- Indoor use.
- Altitude to 2000 m.
- Temperature for safe operation: 5 °C to 40 °C.
- Maximum relative humidity: 80% for temperature up to 31 °C decreasing linearly to 50% at 40 °C.
- Power supply voltage fluctuations not to exceed ±10% of the nominal voltage.
- Overvoltage category II.
- Pollution degree 2.

**Safety Summary (Continued)**

**Ground the Instrument**

To minimize shock hazard, the instrument is equipped with a three-conductor AC power cable. Plug the power cable into an approved three-contact electrical outlet or use a three-contact adapter with the grounding wire (green) firmly connected to an electrical ground (safety ground) at the power outlet. The power jack and mating plug of the power cable meet Underwriters Laboratories (UL) and International Electrotechnical Commission (IEC) safety standards.

**Ventilation**

The instrument has ventilation holes in its side covers. Do not block these holes when the instrument is operating.

**Do Not Operate in an Explosive Atmosphere**

Do not operate the instrument in the presence of flammable gases or fumes. Operation of any electrical instrument in such an environment constitutes a definite safety hazard.

**Keep Away from Live Circuits**

Operating personnel must not remove instrument covers. Refer component replacement and internal adjustments to qualified maintenance personnel. Do not replace components with power cable connected. To avoid injuries, always disconnect power and discharge circuits before touching them.














**Do Not Substitute Parts or Modify Instrument**

Do not install substitute parts or perform any unauthorized modification to the instrument. Return the instrument to an authorized Lake Shore Cryotronics, Inc. representative for service and repair to ensure that safety features are maintained.

**Cleaning**

Do not submerge instrument. Clean only with a damp cloth and mild detergent. Exterior only.

**1.4 SAFETY SYMBOLS**

	Direct current (power line).		Equipment protected throughout by double insulation or reinforced insulation (equivalent to Class II of IEC 536 - see Annex H).
	Alternating current (power line).		Caution: High voltages; danger of electric shock. Background color: Yellow; Symbol and outline: Black.
	Alternating or direct current (power line).		Caution or Warning - See instrument documentation. Background color: Yellow; Symbol and outline: Black.
	Three-phase alternating current (power line).		Fuse.
	Earth (ground) terminal.		
	Protective conductor terminal.		
	Frame or chassis terminal.		
	On (supply).		
	Off (supply).		

This Page Intentionally Left Blank

# CHAPTER 2

## COOLING SYSTEM DESIGN

### 2.0 GENERAL

Selecting the proper cryostat or cooling source is probably the most important decision in designing a temperature control system. The cooling source defines minimum temperature, cool-down time, and cooling power. (Information on choosing a cooling source is beyond the scope of this manual.) This chapter provides information on how to get the best temperature measurement and control from cooling sources with proper setup including sensor and heater installation.

### 2.1 TEMPERATURE SENSOR SELECTION

This section attempts to answer some of the basic questions concerning temperature sensor selection. Additional useful information on temperature sensor selection is available in the Lake Shore Temperature Measurement and Control Catalog. The catalog has a large reference section that includes sensor characteristics and sensor selection criteria.

#### 2.1.1 Temperature Range

Several important sensor parameters must be considered when choosing a sensor. The first is temperature range. The experimental temperature range must be known when choosing a sensor. Some sensors can be damaged by temperatures that are either too high or too low. Manufacturer recommendations should always be followed.

Sensor sensitivity is also dependent on temperature and can limit the useful range of a sensor. It is important not to specify a range larger than necessary. If an experiment is being done at liquid helium temperature, a very high sensitivity is needed for good measurement resolution at that temperature. That same resolution may not be required to monitor warm up to room temperature. Two different sensors may be required to tightly cover the range from helium to room temperature, but lowering the resolution requirement on warm up may allow a less expensive, one sensor solution.

Another thing to consider when choosing a temperature sensor is that instruments like the Model 325 are not able to read some sensors over their entire temperature range. Lake Shore sells calibrated sensors that operate down to 50 millikelvin (mK), but the Model 325 is limited to above 1 kelvin (K) in its standard configuration.

#### 2.1.2 Sensor Sensitivity

Temperature sensor sensitivity is a measure of how much a sensor signal changes when the temperature changes. It is an important sensor characteristic because so many measurement parameters are related to it. Resolution, accuracy, noise floor, and even control stability depend on sensitivity. Many sensors have different sensitivities at different temperatures. For example, a platinum sensor has good sensitivity at higher temperatures but has limited use below 30 K because its sensitivity drops sharply. It is difficult to determine if a sensor has adequate sensitivity over the experimental temperature range. This manual has specifications (Section 1.2) that include sensor sensitivity translated into temperature resolution and accuracy at different points. This is typical sensor response and can be used as a guide when choosing a sensor to be used with the Model 325.

#### 2.1.3 Environmental Conditions

The experimental environment is also important when choosing a sensor. Environmental factors such as high vacuum, magnetic field, corrosive chemicals, or even radiation can limit the use of some types of sensors. Lake Shore has devoted much time to developing sensor packages that withstand the temperatures, vacuum levels, and bonding materials found in typical cryogenic cooling systems.

Experiments done in magnetic fields are becoming very common. Field dependence of temperature sensors is an important selection criteria for sensors used in these experiments. This manual briefly qualifies the field dependence of most common sensors in the specifications (Section 1.2). Detailed field dependence tables are included in the Lake Shore Temperature Measurement and Control Catalog. When available, specific data on other environmental factors is also included in the catalog.

### 2.1.4 Measurement Accuracy

Temperature measurements have several sources of error that reduce accuracy. Be sure to account for errors induced by both the sensor and the instrumentation when computing accuracy. The instrument has measurement error in reading the sensor signal and error in calculating a temperature using a temperature response curve. Error results from the sensor being compared to a calibration standard and the temperature response of a sensor will shift with time and with repeated thermal cycling (from very cold temperatures to room temperature). Instrument and sensor makers specify these errors but there are things a user can do to maintain good accuracy. For example, choose a sensor that has good sensitivity in the most critical temperature range, as sensitivity can minimize the effect of most error sources. Install the sensor properly following guidelines in Section 2.3. Have the sensor and instrument periodically recalibrated, or in some other way null the time dependent errors. Use a sensor calibration that is appropriate for the accuracy requirement.

### 2.1.5 Sensor Package

Many types of sensors can be purchased in different packages. Some types of sensors can even be purchased as bare chips without any package. A sensor package generally determines its size, thermal and electrical contact to the outside, and sometimes limits temperature range. When different packages are available for a sensor, the user should consider the mounting surface for the sensor and how leads will be heat sunk when choosing.

## 2.2 CALIBRATED SENSORS

There can sometimes be confusion in the difficult task of choosing the right sensor, getting it calibrated, translating the calibration data into a temperature response curve that the Model 325 can understand, then getting the curve loaded into the instrument. Lake Shore provides a variety of calibration and curve loading services to fit different accuracy requirements and budgets.

### 2.2.1 Traditional Calibration

Calibration is done by comparing a sensor with an unknown temperature response to an accepted standard. Lake Shore temperature standards are traceable to the U.S. National Institute of Standards and Testing (NIST) or the National Physical Laboratory in Great Britain. These standards allow Lake Shore to calibrate sensors from 50 mK to above room temperature. Calibrated sensors are more expensive than uncalibrated sensors of the same type because of the labor and capitol equipment used in the process.

This type of calibration provides the most accurate temperature sensors available from Lake Shore. Errors from sensor calibration are almost always smaller than the error contributed by the Model 325. The Lake Shore Temperature Measurement and Control Catalog has complete accuracy specifications for calibrated sensors.

Calibrated sensors include the measured test data printed and plotted, the coefficients of a Chebychev polynomial that has been fitted to the data, and two tables of data points to be used as interpolation tables. Both interpolation tables are optimized to allow accurate temperature conversion. The smaller table, called a breakpoint interpolation table, is sized to fit into instruments like the Model 325 where it is called a temperature response curve. Getting a curve into a Model 325 may require a CalCurve™ described below or hand entering through the instrument front panel.

It is important to look at instrument specifications before ordering calibrated sensors. A calibrated sensor is required when a sensor does not follow a standard curve *if* the user wishes to display in temperature. Otherwise the Model 325 will operate in sensor units like ohms or volts. The Model 325 may not work over the full temperature range of some sensors. The standard inputs in are limited to operation above 1 K even with sensors that can be calibrated to 50 mK.

### 2.2.2 SoftCal™

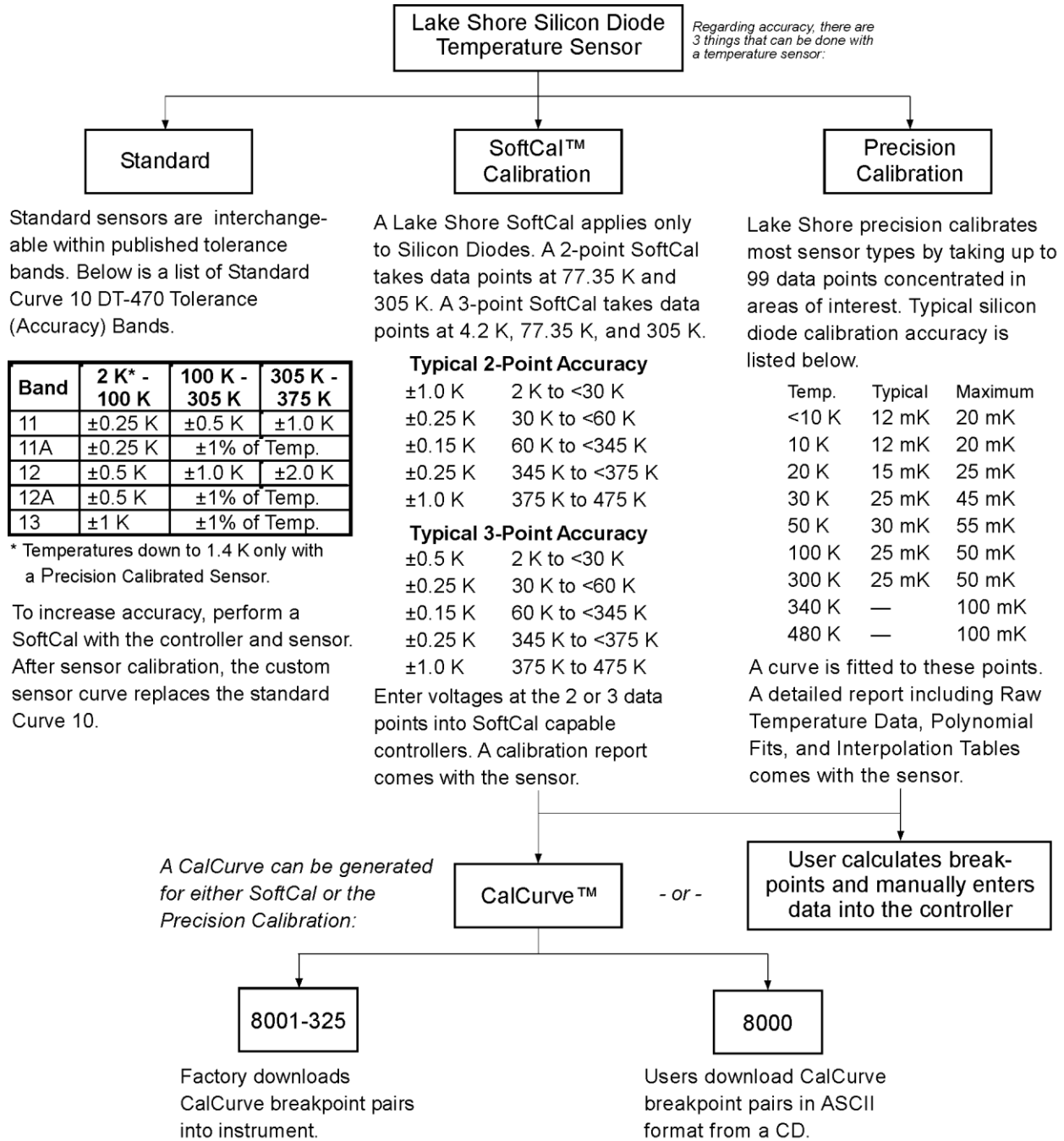
SoftCal is a good solution for applications that do not require the accuracy of a traditional calibration. The SoftCal algorithm uses the well-behaved nature of sensors that follow a standard curve to improve the accuracy of individual sensors. A few known temperature points are required to perform SoftCal.

Lake Shore sells SoftCal calibrated sensors that include both the large interpolation table and the smaller breakpoint interpolation table. A CalCurve may be required to get the breakpoint table into a Model 325 where it is called a temperature response curve. Refer to Section 2.2.4.

The Model 325 can also perform a SoftCal calibration. The user must provide one, two, or three known temperature reference points. The range and accuracy of the calibration is based on these points. Refer to Section 5.3.

### 2.2.3 Standard Curves

Some types of sensors behave in a very predictable manner and a standard temperature response curve can be created for them. Standard curves are a convenient and inexpensive way to get reasonable temperature accuracy. Sensors that have a standard curve are often used when interchangeability is important. Some individual sensors are selected for their ability to match a published standard curve and sold at a premium, but in general these sensors do not provide the accuracy of a calibrated sensor. For convenience, the Model 325 has several standard curves included in firmware.



C-325-2-1.bmp

**Figure 2-1. Silicon Diode Sensor Calibrations and CalCurve**

### 2.2.4 CalCurve™

The CalCurve service provides the user with a convenient way get the temperature response curve from Lake Shore calibrated sensors into instruments like the Model 325. It can be performed at the factory when calibrated sensors and instruments are ordered together. The factory installed CalCurve option is Model 8001-325 and should be ordered with the calibrated sensor. A CalCurve can be done in the field when additional or replacement sensors are installed. Customers that have a PC-compatible computer with an RS-232C or IEEE-488 interface can load the curve into the instrument using one of the computer interfaces. The Model 8000 CalCurve is offered on CD or via e-mail free of charge at time of order to any customer who orders a calibrated sensor. See Section 7.2 for details.

## 2.3 SENSOR INSTALLATION

This section highlights some of the important elements of proper sensor installation. For more detailed information, Lake Shore sensors are shipped with installation instructions that cover that specific sensor type and package. The Lake Shore Temperature Measurement and Control Catalog includes an installation section as well. To further help users properly install sensors, Lake Shore offers a line of cryogenic accessories. Many of the materials discussed are available through Lake Shore and can be ordered with sensors or instruments.

### 2.3.1 Mounting Materials

Choosing appropriate mounting materials is very important in a cryogenic environment. The high vacuum used to insulate cryostats is one source of problems. Materials used in these applications should have a low vapor pressure so they do not evaporate or out-gas and spoil the vacuum insulation. Metals and ceramics do not have this problem but greases and varnishes must be checked. Another source of problems is the wide extremes in temperature most sensors are exposed to. The linear expansion coefficient of materials becomes important when temperature changes are so large. Never try to permanently bond materials with linear expansion coefficients that differ by more than three. A flexible mounting scheme should be used or the parts will break apart, potentially damaging them. The thermal expansion or contraction of rigid clamps or holders could crush fragile samples or sensors that do not have the same coefficient. Thermal conductivity is a property of materials that can change with temperature. Do not assume that a heat sink grease that works well at room temperature and above will do the same job at low temperatures.

### 2.3.2 Sensor Location

Finding a good place to mount a sensor in an already crowded cryostat is never easy. There are fewer problems if the entire load and sample holder are at the same temperature. Unfortunately, this not the case in many systems. Temperature gradients (differences in temperature) exist because there is seldom perfect balance between the cooling source and heat sources. Even in a well-controlled system, unwanted heat sources like thermal radiation and heat conducting through mounting structures can cause gradients. For best accuracy, sensors should be positioned near the sample, so that little or no heat flows between the sample and sensor. This may not, however, be the best location for temperature control as discussed below.

### 2.3.3 Thermal Conductivity

The ability of heat to flow through a material is called thermal conductivity. Good thermal conductivity is important in any part of a cryogenic system that is intended to be the same temperature. Copper and aluminum are examples of metals that have good thermal conductivity, while stainless steel does not. Non-metallic, electrically-insulating materials like alumina oxide and similar ceramics have good thermal conductivity, while G-10 epoxy-impregnated fiberglass does not. Sensor packages, cooling loads, and sample holders should have good thermal conductivity to reduce temperature gradients. Surprisingly, the connections between thermally conductive mounting surfaces often have very poor thermal conductivity.

### 2.3.4 Contact Area

Thermal contact area greatly affects thermal conduction because a larger area has more opportunity to transfer heat. Even when the size of a sensor package is fixed, thermal contact area can be improved with the use of a gasket material. A soft gasket material forms into the rough mating surface to increase the area of the two surfaces that are in contact. Good gasket materials are soft, thin, and have good thermal conductivity. They must also withstand the environmental extremes. Indium foil and cryogenic grease are good examples.

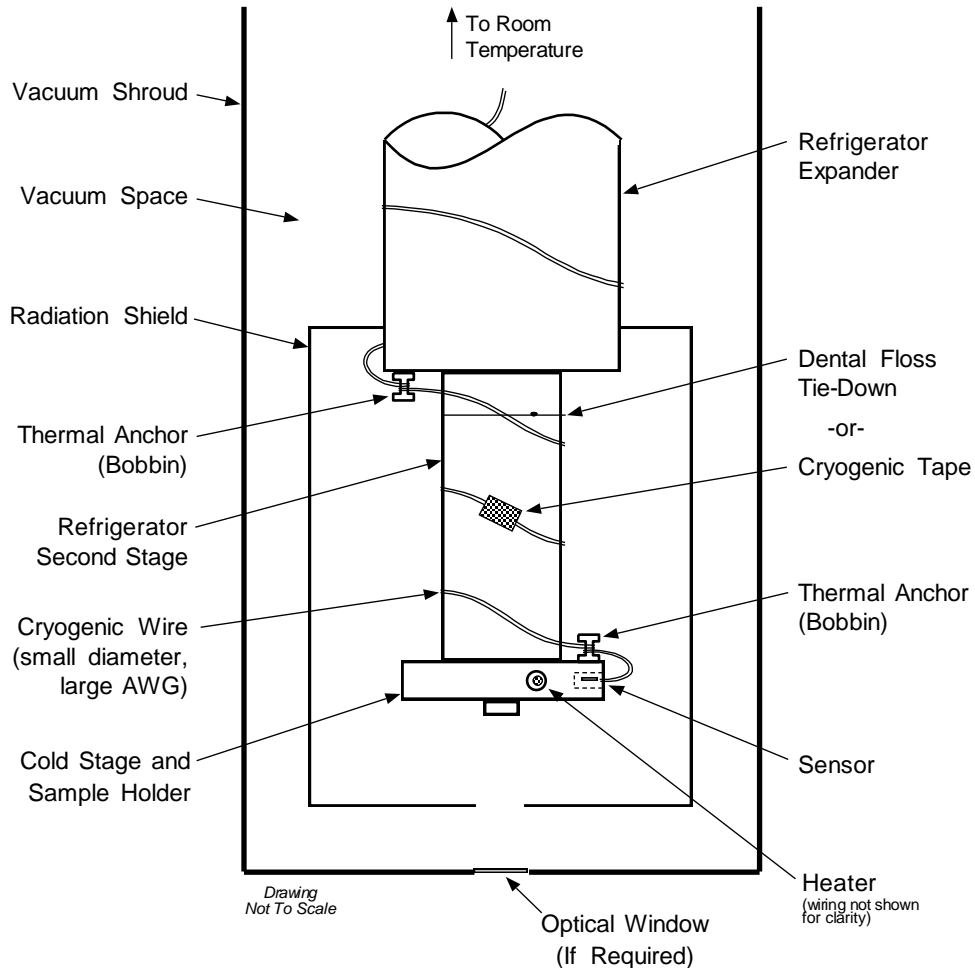


### 2.3.5 Contact Pressure

When sensors are permanently mounted, the solder or epoxy used to hold the sensor act as both gasket and adhesive. Permanent mounting is not a good solution for everyone because it limits flexibility and can potentially damage sensors. Much care should be taken not to over heat or mechanically stress sensor packages. Less permanent mountings require some pressure to hold the sensor to its mounting surface. Pressure greatly improves the action of gasket material to increase thermal conductivity and reduce thermal gradients. A spring clamp is recommended so that different rates of thermal expansion do not increase or decrease pressure with temperature change.

### 2.3.6 Lead Wire

Different types of sensors come with different types and lengths of electrical leads. In general a significant length of lead wire must be added to the sensor for proper heat sinking and connecting to a bulk head connector at the vacuum boundary. The lead wire must be a good electrical conductor, but should not be a good *thermal* conductor, or heat will transfer down the leads and change the temperature reading of the sensor. Small 30 to 40 AWG wire made of an alloy like phosphor bronze is much better than copper wire. Thin wire insulation is preferred and twisted wire should be used to reduce the effect of RF noise if it is present. The wire used on the room temperature side of the vacuum boundary is not critical so copper cable is normally used.



P-325-2-2.bmp

Figure 2-2. Typical Sensor Installation In A Mechanical Refrigerator

### 2.3.7 Lead Soldering

When additional wire is soldered to short sensor leads, care must be taken not to overheat the sensor. A heat sink such as a metal wire clamp or alligator clip will heat sink the leads and protect the sensor. Leads should be tinned before bonding to reduce the time that heat is applied to the sensor lead. Solder flux should be cleaned after soldering to prevent corrosion.

### 2.3.8 Heat Sinking Leads

Sensor leads can be a significant source of error if they are not properly heat sunk. Heat will transfer down even small leads and alter the sensor reading. The goal of heat sinking is to cool the leads to a temperature as close to the sensor as possible. This can be accomplished by putting a significant length of lead wire in thermal contact with every cooled surface between room temperature and the sensor. Lead wires can be adhered to cold surfaces with varnish over a thin electrical insulator like cigarette paper. They can also be wound onto a bobbin that is firmly attached to the cold surface. Some sensor packages include a heat sink bobbin and wrapped lead wires to simplify heat sinking.

### 2.3.9 Thermal Radiation

Thermal (black body) radiation is one of the ways heat is transferred. Warm surfaces radiate heat to cold surfaces even through a vacuum. The difference in temperature between the surfaces is one thing that determines how much heat is transferred. Thermal radiation causes thermal gradients and reduces measurement accuracy. Many cooling systems include a radiation shield. The purpose of the shield is to surround the load, sample, and sensor with a surface that is at or near their temperature to minimize radiation. The shield is exposed to the room temperature surface of the vacuum shroud on its outer surface, so some cooling power must be directed to the shield to keep it near the load temperature. If the cooling system does not include an integrated radiation shield (or one cannot be easily made), one alternative is to wrap several layers of super-insulation (aluminized mylar) loosely between the vacuum shroud and load. This reduces radiation transfer to the sample space.

## 2.4 HEATER SELECTION AND INSTALLATION

There is a variety of resistive heaters that can be used as the controlled heating source for temperature control. The mostly metal alloys like nichrome are usually wire or foil. Shapes and sizes vary to permit installation into different systems.

### 2.4.1 Heater Resistance and Power

Cryogenic cooling systems have a wide range of cooling power. The resistive heater must be able to provide sufficient heating power to warm the system. The Model 325 can supply up to 25 W of power to a heater (if the heater resistance is appropriate). The Model 325 heater output current source has a maximum output of 1 A at the 25  $\Omega$  setting, or 0.71 A at the 50  $\Omega$  setting. Even though the Model 325 main heater output is a current source, it has a voltage limit (called the compliance voltage) which is set to either 25 V or 35.4 V when the heater resistance is set to 25  $\Omega$  or 50  $\Omega$ , respectively. This compliance voltage also limits maximum power.

	Max Power (W) at 25 $\Omega$ Setting	Max Power (W) at 50 $\Omega$ Setting
Voltage Limit:	$\frac{(25 \text{ V})^2}{\text{Resistance } (\Omega)}$	$\frac{(35.4 \text{ V})^2}{\text{Resistance } (\Omega)}$
Current Limit:	$(1 \text{ A})^2 \times \text{Resistance } (\Omega)$	$(0.71 \text{ A})^2 \times \text{Resistance } (\Omega)$

Both limits are in place at the same time, so the smaller of the two computations gives the maximum power available to the heater. A heater of 50  $\Omega$  at the 50  $\Omega$  setting allows the instrument to provide its maximum power of 25 W. A smaller resistance of 40  $\Omega$  at the 50  $\Omega$  setting allows about 20 W of power, while a larger resistance of 60  $\Omega$  is limited by compliance voltage to about 21 W. The Model 325 is designed to limit the internal power dissipation as a measure of self-protection. This internal power limit will not allow the output current to rise once the power limit is reached.

The resistor chosen as a heater must be able to withstand the power being dissipated in it. Pre-packaged resistors have a power specification that is usually given for the resistor in free air. This power may need to be derated if used in a vacuum where convection cooling cannot take place and it is not adequately heat sunk to a cooled surface.

### **2.4.2 Heater Location**

For best temperature measurement accuracy the heater should be located so that heat flow between the cooling power and heater is minimized. For best control the heater should be in close thermal contact with the cooling power. Geometry of the load can make one or both of these difficult to achieve. That is why there are several heater shapes and sizes.

### **2.4.3 Heater Types**

Resistive wire like nichrome is the most flexible type of heater available. The wire can be purchased with electrical insulation and has a predictable resistance per given length. This type of heater wire can be wrapped around a cooling load to give balanced, even heating of the area. Similar to sensor lead wire, the entire length of the heater wire should be in good thermal contact with the load to allow for thermal transfer. Heat sinking also protects the wire from over heating and burning out.

Resistive heater wire is also wound into cartridge heaters. Cartridge heaters are more convenient but are bulky and more difficult to place on small loads. A typical cartridge is 0.25 inch in diameter and 1 inch long. The cartridge should be snugly held in a hole in the load or clamped to a flat surface. Heat sinking for good thermal contact is again important.

Foil heaters are thin layers of resistive material adhered to, or screened on to, electrically insulating sheets. There are a variety of shapes and sizes. The proper size heater can evenly heat a flat surface or around a round load. The entire active area should be in good thermal contact with the load, not only for maximum heating effect, but to keep spots in the heater from over heating and burning out.

### **2.4.4 Heater Wiring**

When wiring inside a vacuum shroud, we recommend using 30 AWG copper wire for heater leads. Too much heat can leak in when larger wire is used. Heat sinking, similar to that used for the sensor leads, should be included so that any heat leaking in does not warm the load when the heater is not running. The lead wires should be twisted to minimize noise coupling between the heater and other leads in the system. When wiring outside the vacuum shroud, larger gage copper cable can be used, and twisting is still recommended.

## **2.5 CONSIDERATION FOR GOOD CONTROL**

Most of the techniques discussed above to improve cryogenic temperature accuracy apply to control as well. There is an obvious exception in sensor location. A compromise is suggested below in Section 2.5.3 – Two Sensor Approach.

### **2.5.1 Thermal Conductivity**

Good thermal conductivity is important in any part of a cryogenic system that is intended to be at the same temperature. Most systems begin with materials that have good conductivity themselves, but as sensors, heaters, sample holders, etc., are added to an ever more crowded space, the junctions between parts are often overlooked. In order for control to work well, junctions between the elements of the control loop must be in close thermal contact and have good thermal conductivity. Gasket materials should always be used along with reasonable pressure.

### **2.5.2 Thermal Lag**

Poor thermal conductivity causes thermal gradients that reduce accuracy and also cause thermal lag that make it difficult for controllers to do their job. Thermal lag is the time it takes for a change in heating or cooling power to propagate through the load and get to the feedback sensor. Because the feedback sensor is the only thing that lets the controller know what is happening in the system, slow information to the sensor slows the response time. For example, if the temperature at the load drops slightly below the setpoint, the controller gradually increases heating power. If the feedback information is slow, the controller puts too much heat into the system before it is told to reduce heat. The excess heat causes a temperature overshoot, which degrades control stability. The best way to improve thermal lag is to pay close attention to thermal conductivity both in the parts used and their junctions.

### **2.5.3 Two-Sensor Approach**

There is a conflict between the best sensor location for measurement accuracy and the best sensor location for control. For measurement accuracy the sensor should be very near the sample being measured, which is away from the heating and cooling sources to reduce heat flow across the sample and thermal gradients. The best control stability is achieved when the feedback sensor is near both the heater and cooling source to reduce thermal lag. If both control stability and measurement accuracy are critical it may be necessary to use two sensors, one for each function. Many temperature controllers including the Model 325 have two sensor inputs for this reason.

## 2.5.4 Thermal Mass

Cryogenic designers understandably want to keep the thermal mass of the load as small as possible so the system can cool quickly and improve cycle time. Small mass can also have the advantage of reduced thermal gradients. Controlling a very small mass is difficult because there is no buffer to adsorb small changes in the system. Without buffering, small disturbances can very quickly create large temperature changes. In some systems it is necessary to add a small amount of thermal mass such as a copper block in order to improve control stability.

## 2.5.5 System Nonlinearity

Because of nonlinearities in the control system, a system controlling well at one temperature may not control well at another temperature. While nonlinearities exist in all temperature control systems, they are most evident at cryogenic temperatures. When the operating temperature changes the behavior of the control loop, the controller must be retuned. As an example, a thermal mass acts differently at different temperatures. The specific heat of the load material is a major factor in thermal mass and the specific heat of materials like copper change as much as three orders of magnitude when cooled from 100 K to 10 K. Changes in cooling power and sensor sensitivity are also sources of nonlinearity.

The cooling power of most cooling sources also changes with load temperature. This is very important when operating at temperatures near the highest or lowest temperature that a system can reach. Nonlinearities within a few degrees of these high and low temperatures make it very difficult to configure them for stable control. If difficulty is encountered, it is recommended to gain experience with the system at temperatures several degrees away from the limit and gradually approach it in small steps.

Keep an eye on temperature sensitivity. Sensitivity not only affects control stability but it also contributes to the overall control system gain. The large changes in sensitivity that make some sensors so useful may make it necessary to retune the control loop more often.

## 2.6 PID CONTROL

For closed-loop operation, the Model 325 temperature controller uses a algorithm called PID control. The control equation for the PID algorithm has three variable terms: proportional (P), integral (I), and derivative (D). See Figure 2-3. Changing these variables for best control of a system is called tuning. The PID equation in the Model 325 is:

where the error (e) is defined as:  $e = \text{Setpoint} - \text{Feedback Reading}$ .

Proportional is discussed in Section 2.6.1. Integral is discussed in Section 2.6.2. Derivative is discussed in Section 2.6.3. Finally, the manual heater output is discussed in Section 2.6.4.

### 2.6.1 Proportional (P)

The Proportional term, also called gain, must have a value greater than zero for the control loop to operate. The value of the proportional term is multiplied by the error (e) which is defined as the difference between the setpoint and feedback temperatures, to generate the proportional contribution to the output:  $\text{Output (P)} = Pe$ . If proportional is acting alone, with no integral, there must always be an error or the output will go to zero. A great deal must be known about the load, sensor, and controller to compute a proportional setting (P). Most often, the proportional setting is determined by trial and error. The proportional setting is part of the overall control loop gain, and so are the heater range and cooling power. The proportional setting will need to change if either of these change.

### 2.6.2 Integral (I)

In the control loop, the integral term, also called reset, looks at error over time to build the integral contribution to the output:

By adding the integral to proportional contributions, the error that is necessary in a proportional only system can be eliminated. When the error is at zero, controlling at the setpoint, the output is held constant by the integral contribution. The integral setting (I) is more predictable than the gain setting. It is related to the dominant time constant of the load. As discussed in Section 2.7.3, measuring this time constant allows a reasonable calculation of the integral setting. In the Model 325, the integral term is not set in seconds like some other systems. The integral setting can be derived by dividing 1000 by the integral seconds:  $I_{\text{setting}} = 1000 / I_{\text{seconds}}$ .

### 2.6.3 Derivative (D)

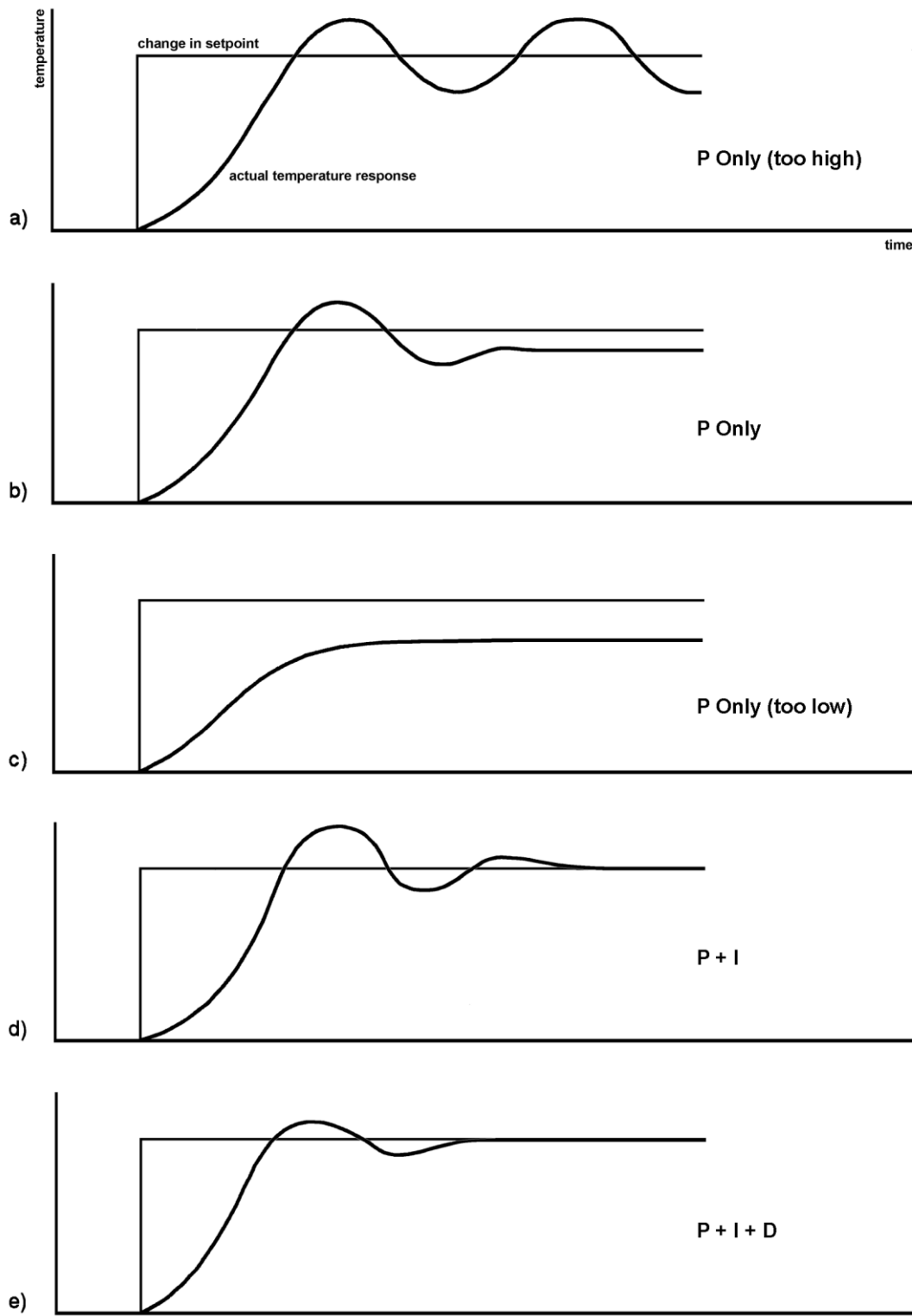
The derivative term, also called rate, acts on the change in error with time to make its contribution to the output:

By reacting to a fast changing error signal the derivative can work to boost the output when the setpoint changes quickly, reducing the time it takes for temperature to reach the setpoint. It can also see the error decreasing rapidly when the temperature nears the setpoint and reduce the output for less overshoot. The derivative term can be useful in fast changing systems but it is often turned off during steady state control because it reacts too strongly to small disturbances. The derivative setting (D) is related to the dominant time constant of the load similar to the  $I_{\text{setting}}$  and is therefore set proportional to  $I_{\text{setting}}$  when used.

### 2.6.4 Manual Heater Power (MHP) Output

The Model 325 has a control setting that is not a normal part of a PID control loop. Manual Heater Power (MHP) output can be used for open loop control, meaning feedback is ignored and the heater output stays at the users manual setting. This is a good way to put constant heating power into a load when needed. The MHP output term can also be added to the PID output. Some users prefer to set a power near that necessary to control at a setpoint and let the closed loop make up the small difference. MHP output is set in percent of full scale current or power for a given heater range.

**NOTE:** MHP output should be set to 0% when not in use.



P-325-2-3.bmp

Figure 2-3. Examples of PID Control

## 2.7 MANUAL TUNING

There has been a lot written about tuning closed loop control systems and specifically PID control loops. This section does not attempt to compete with control theory experts. It describes a few basic rules of thumb to help less experienced users get started. This technique will not solve every problem, but it has worked for many others in the field. This section assumes the user has worked through the operation sections of this manual, has a good temperature reading from the sensor chosen as a control sensor, and is operating Loop 1. It is also a good idea to begin at the center of the temperature range of the cooling system (not close to its highest or lowest temperature). AutoTune (Section 2.8) is another good place to begin, and do not forget the power of trial and error.

### 2.7.1 Setting Heater Range

Setting an appropriate heater output range is an important first part of the tuning process. *The heater range should allow enough heater power to comfortably overcome the cooling power of the cooling system.* If the heater range will not provide enough power, the load will not be able to reach the setpoint temperature. If the range is set too high, the load may have very large temperature changes that take a long time to settle out. Delicate loads can even be damaged by too much power.

Often there is little information on the cooling power of the cooling system at the desired setpoint. If this is the case, try the following: Allow the load to cool completely with the heater off. Set manual heater power output to 50% while in Open Loop control mode. Turn the heater to the lowest range and write down the temperature rise (if any). Select the next highest heater range and continue the process until the load warms up to room temperature. Do not leave the system unattended; the heater may have to be turned off manually to prevent overheating. If the load never reaches room temperature, some adjustment may be needed in heater resistance or load.

The list of heater range versus load temperature is a good reference for selection the proper heater range. It is common for systems to require two or more heater ranges for good control over their full temperature. Lower heater ranges are normally needed for lower temperature. The Model 325 is of no use controlling at or below the temperature reached when the heater was off. Many systems can be tuned to control within a degree or two above that temperature.

### 2.7.2 Tuning Proportional

The proportional setting is so closely tied to heater range that they can be thought of as fine and course adjustments of the same setting. An appropriate heater range must be known before moving on to the proportional setting.

Begin this part of the tuning process by letting the cooling system cool and stabilize with the heater off. Place the Model 325 in closed loop control mode with manual PID tuning, then turn integral, derivative and manual output settings off. Enter a setpoint several degrees above the cooling systems lowest temperature. Enter a low proportional setting of approximately 5 or 10 and then enter the appropriate heater range as described above. The heater display should show a value greater than zero and less than 100%. The load temperature should stabilize at a temperature below the setpoint. If the load temperature and heater meter swing rapidly, the heater range may be set too high and should be reduced. Very slow changes in load temperature that could be described as drifting are an indication of a proportional setting that is too low (which is addressed in the next step).

Gradually increase the proportional setting by doubling it each time. At each new setting, allow time for the temperature of the load to stabilize. As the proportional setting is increased, there should be a setting in which the load temperature begins a sustained and predictable oscillation rising and falling in a consistent period of time. See Figure 2-3(a). The goal is to find the proportional value in which the oscillation begins, do not turn the setting so high that temperature and heater output changes become violent.

Record the proportional setting and the amount of time it takes for the load change from one temperature peak to the next. The time is called the oscillation period of the load. It helps describe the dominant time constant of the load, which is used in setting integral. If all has gone well, the appropriate proportional setting is *one half* of the value required for sustained oscillation. See Figure 2-3(b).

### **Tuning Proportional (Continued)**

If the load does not oscillate in a controlled manner, the heater range could be set too low. A constant heater reading of 100% on the display would be an indication of a low range setting. The heater range could also be too high, indicated by rapid changes in the load temperature or heater output with a proportional setting of less than 5. There are a few systems that will stabilize and not oscillate with a very high proportional setting and a proper heater range setting. For these systems, setting a proportional setting of one half of the highest setting is the best choice.

### **2.7.3 Tuning Integral**

When the proportional setting is chosen and the integral is set to zero (off), the Model 325 controls the load temperature below the setpoint. Setting the integral allows the Model 325 control algorithm to gradually eliminate the difference in temperature by integrating the error over time. See Figure 2-3(d). An integral setting that is too low causes the load to take too long to reach the setpoint. An integral setting that is too high creates instability and can cause the load temperature to oscillate.

Begin this part of the tuning process with the system controlling in proportional only mode. Use the oscillation period of the load that was measured above in seconds. *Divide 1000 by the period to get the integral setting.* Enter the integral setting into the Model 325 and watch the load temperature approach the setpoint. If the temperature does not stabilize and begins to oscillate around the setpoint, the integral setting is too high and should be reduced by one half. If the temperature is stable but never reaches the setpoint, the integral setting is too low and should be doubled.

To verify the integral setting make a few small (2 to 5 degree) changes in setpoint and watch the load temperature react. Trial and error can help improve the integral setting by optimizing for experimental needs. Faster integrals, for example, get to the setpoint more quickly at the expense of greater overshoot. In most systems, setpoint changes that raise the temperature act differently than changes that lower the temperature.

If it was not possible to measure the oscillation period of the load during proportional setting, start with an integral setting of 20. If the load becomes unstable reduce the setting by half. If the load is stable make a series of small, two to five degree, changes in the setpoint and watch the load react. Continue to increase the integral setting until the desired response is achieved.

### **2.7.4 Tuning Derivative**

If an experiment requires frequent changes in setpoint or data taking between changes in the setpoint, derivative should be considered. See Figure 2-3(e). A derivative setting of zero, off, is recommended when the control system is seldom changed and data is taken when the load is at steady state.

The derivative setting is entered into the Model 325 as a percentage of the integral time constant. The setting range is 0 – 200% where 100% =  $\frac{1}{4}$  I seconds. Start with a setting of 50 to 100%.

Again, do not be afraid to make some small setpoint changes; halving or doubling this setting to watch the affect. Expect positive setpoint changes to react differently from negative setpoint changes.

## **2.8 AUTOTUNING**

Choosing appropriate PID control settings can be tedious. Systems can take several minutes to complete a setpoint change, making it difficult to watch the display for oscillation periods and signs of instability. With the AutoTune feature, the Model 325 automates the tuning process by measuring system characteristics and, along with some assumptions about typical cryogenic systems, computes setting values for P, I, and D. AutoTune works only with one control loop at a time and does not set the manual heater power output or heater range. Setting an inappropriate heater range is potentially dangerous to some loads, so the Model 325 does not automate that step of the tuning process.

When the AutoTune mode is selected, the Model 325 evaluates the control loop similar to the manual tuning section described in Section 2.7. One difference is that the Model 325 does not initiate changes to control settings or setpoint for the purpose of tuning. *It only gathers data and changes control settings after the user changes the setpoint.* Unexpected or unwanted disturbances to the control system can ruin experimental data being taken by the user.



**AutoTuning (Continued)**

When the user selects a new setpoint, the Model 325 logs the change in temperature at the load and the change in heater output that was required to make the load temperature change. The old control settings are used while data is being logged, so a good initial guess of settings can improve the efficiency of the AutoTune feature. Once the load temperature is at or near the new setpoint, the Model 325 looks at the logged data to calculate the best P, I, and D settings values. Those values are then loaded and used as the control parameters so the control loop can stabilize at the new setpoint. AutoTune does not function during a ramp because the dominant time constant of the load is disguised by the ramp rate.

The control channel annunciator blinks to indicate that tuning data is being logged. The control channel annunciator stops blinking when the tuning process is complete. The control channel annunciator will not blink again until the user changes the setpoint. If AutoTune does not give desired results the first time, make a few small (2 to 5 degree) changes in setpoint and let the Model 325 go until the control channel annunciator stops blinking. In many cases, AutoTune is able to arrive at a better set of control settings.

There are situations where AutoTune is not the answer. The algorithm can be fooled when cooling systems are very fast, very slow, have a large thermal lag, or have a nonlinear relationship between heater power and load temperature. If a load can reach a new setpoint in under 10 seconds (with an appropriate I setting  $>500$ ), the cooling system is too fast for AutoTuning. Systems with a very small thermal mass can be this fast. Adding mass is a solution, but is unappealing to users who need the speed for fast cycle times. Manual tuning is not difficult on these systems because new settings can be tested very quickly. Some systems are too slow for the AutoTune algorithm. Any system that takes more than 15 minutes to stabilize at a new setpoint is too slow (with an appropriate I setting  $<5$ ).

Thermal lag can be improved by using the sensor and heater installation techniques discussed above. Lag times up to a few seconds should be expected; much larger lags can be a problem. System nonlinearity is a problem for both AutoTune and manual tuning. It is most commonly noticed when controlling near the maximum or minimum temperature of a temperature control system. It is not uncommon; however, for a user to buy a cryogenic cooling system specifically to operate near its minimum temperature. If this is the case, try to tune the system at 5 degrees above the minimum temperature and gradually reduce the setpoint, manually adjusting the control settings with each step. Any time the mechanical cooling action of a cryogenic refrigerator can be seen as periodic temperature fluctuations, the mass is too small or temperature too low to AutoTune.

**2.9 ZONE TUNING**

Once the PID tuning parameters have been chosen for a given setpoint the whole process may have to be done again for other setpoints significantly far away that have different tuning needs. Trying to remember when to use which set of tuning parameters can be frustrating. The Model 325 has a Zone feature as one of its tuning modes that can help.

To use the Zone feature the user must determine the best tuning parameters for each part of the temperature range of interest. The parameters are then entered into the Model 325 where up to ten zones can be defined with different P, I, D, heater range, and manual heater settings. A setpoint setting is assigned as the maximum temperature for that zone. The minimum temperature for a zone is the setpoint for the previous zone, 0 K is the starting point for the first zone. When Zone tuning is on, each time the setpoint changes, appropriate control parameters are chosen automatically.

Control parameters can be determined manually or by using the AutoTune feature. AutoTune is a good way to determine a set of tuning parameters for the control system that can then be entered as zones. Once the parameters are chosen, AutoTune is turned off and zone tuning takes over.

Zone tuning has advantages over AutoTune during normal operation. When a new setpoint is set the zone tuning automatically sets the appropriate control parameters for the destination. Approach to the new setpoint is controlled with the best parameters. AutoTune, on the other hand, is not able to learn enough about the system to change the control parameters until after the temperature gets near or to the new setpoint. Approach to the new setpoint is controlled with the old parameters because they are the best available.

This Page Intentionally Left Blank

# CHAPTER 3

## INSTALLATION

### 3.0 GENERAL

This chapter provides general installation instructions for the Model 325 Temperature Controller. Please read this entire chapter before installing the instrument and powering it on to ensure the best possible performance and maintain operator safety. For instrument operating instructions refer to Chapter 4 and Chapter 5. For computer interface installation and operation refer to Chapter 6.

### 3.1 INSPECTION AND UNPACKING

Inspect shipping containers for external damage before opening them. Photograph any container that has significant damage before opening it. If there is visible damage to the contents of the container contact the shipping company and Lake Shore immediately, preferably within 5 days of receipt of goods. Keep all damaged shipping materials and contents until instructed to either return or discard them.

Open the shipping container and keep the container and shipping materials until all contents have been accounted for. Check off each item on the packing list as it is unpacked. Instruments themselves may be shipped as several parts. The items included with the Model 325 are listed below. Contact Lake Shore immediately if there is a shortage of parts or accessories. Lake Shore is not responsible for any missing items if not notified within 60 days of shipment.

Inspect all items for both visible and hidden damage that occurred during shipment. If damage is found, contact Lake Shore immediately for instructions on how to file a proper insurance claim. Lake Shore products are insured against damage during shipment but a timely claim must be filed before Lake Shore will take further action. Procedures vary slightly with shipping companies. Keep all shipping materials and damaged contents until instructed to either return or discard them.

If the instrument must be returned for recalibration, replacement or repair, a Return Authorization (RA) number must be obtained from a factory representative before it is returned. The Lake Shore RA procedure is given in Section 8.2.

#### Items Included with Model 325 Temperature Controller:

- 1 Model 325 Instrument
- 1 Model 325 User's Manual
- 2 Sensor input mating connector, 6-pin DIN
- 1 Heater output connector, dual banana, for Loop 1 Heater Out
- 1 Terminal block mating connector, 2-pin terminal block, for Loop 2 Heater Out
- 1 Line Power Cord
- 1 Line Power Cord for Alternative Voltage\*

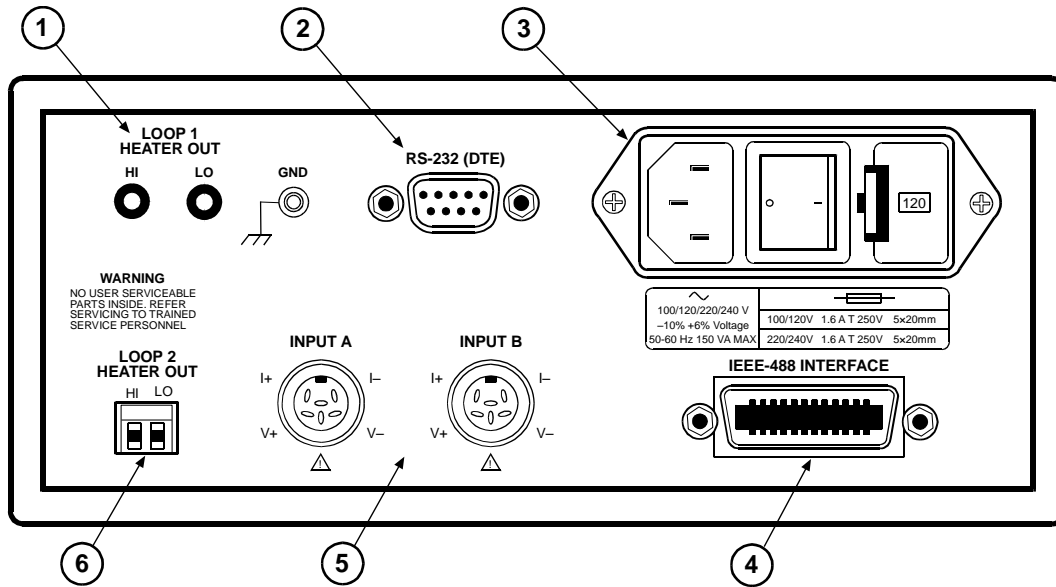
\* Included only when purchased with VAC-120-ALL power option.

### 3.2 REAR PANEL DEFINITION

This section provides a description of the Model 325 rear panel connections. The rear panel consists of the line input assembly, RS-232 Connector, INPUT A and B Sensor Input Connectors, IEEE-488 INTERFACE Connector, and LOOP 1 and 2 HEATER OUT Connectors. Please read the entire chapter before performing the initial setup and system checkout procedure in Section 3.7. Rear panel connector pin-out details are provided in Section 8.7.

**CAUTION:** Verify AC line voltage shown in the fuse holder window is appropriate for the intended AC power input. Also remove and verify the proper fuse is installed before plugging in and turning on the instrument.

**CAUTION:** Always turn off the instrument before making any rear panel connections. This is especially critical when making sensor to instrument connections.



F-325-3-L.wmf

		<i>Description</i>	<i>Details</i>
①	Loop 1 Heater Out Banana Jack and Ground Screw Terminal	Section 3.6	Figure 8-4
②	RS-232 (DTE) 9-pin D-Style Connector	Section 6.2.1	Figure 8-6
③	Line Input Assembly	Section 3.3	Figure 8-2
④	IEEE-488 INTERFACE Connector	Section 8.7.2	Figure 8-7
⑤	INPUT A and INPUT B Sensor (or Thermocouple) Input Connectors	Sections 3.4 and 3.5	Figure 8-3 and 3-4
⑥	Loop 2 Heater Out	Section 3.6	Figure 8-5

**Figure 3-1. Model 325 Rear Panel**

### 3.3 LINE INPUT ASSEMBLY

This section describes how to properly connect the Model 325 to line power. Please follow these instructions carefully to ensure proper operation of the instrument and the safety of operators.

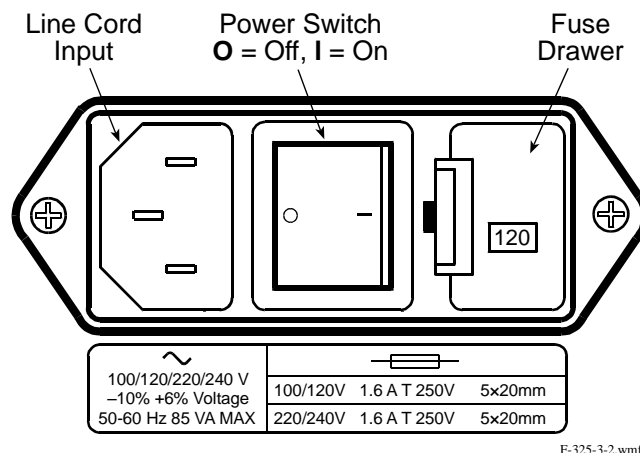


Figure 3-2. Line Input Assembly

#### 3.3.1 Line Voltage

The Model 325 has four different AC line voltages configurations so that it can be operated from line power anywhere in the world. The nominal voltage and voltage range of each configuration is shown below. (The recommended setting for 230 V operation is 240 V.)

<i>Nominal</i>	<i>Minimum</i>	<i>Maximum</i>
100 V	90 V	106 V
120 V	108 V	127 V
220 V	198 V	233 V
240 V	216 V	254 V

Verify that the AC line voltage indicator in the fuse drawer window shows the appropriate AC line voltage before turning the instrument on. The instrument may be damaged if turned on with the wrong voltage selected. Instructions for changing the line voltage configuration are given in Section 8.4.

#### 3.3.2 Line Fuse and Fuse Holder

The line fuse is an important safety feature of the Model 325. If a fuse ever fails, it is important to replace it with the value and type indicated on the rear panel for the line voltage setting. The letter T on the fuse rating indicates that the instrument requires a time-delay or slow-blow fuse. Fuse values should be verified any time line voltage configuration is changed. Instructions for changing and verifying a line fuse are given in Section 8.5.

#### 3.3.3 Power Cord

The Model 325 includes a 3-conductor power cord that mates with the IEC 320-C14 line cord receptacle. Line voltage is present on the two outside conductors and the center conductor is a safety ground. The safety ground attaches to the instrument chassis and protects the user in case of a component failure. A CE approved power cord is included with instruments shipped to Europe; a domestic power cord is included with all other instruments (unless otherwise specified when ordered). Always plug the power cord into a properly grounded receptacle to ensure safe instrument operation.

The delicate nature of measurements being taken with this instrument may necessitate additional grounding including ground strapping of the instrument chassis. In these cases the operators safety should remain the highest priority and low impedance from the instrument chassis to safety ground should always be maintained.

#### 3.3.4 Power Switch

The power switch is part of the line input assembly on the rear panel of the Model 325 and turns line power to the instrument On and Off. When the circle is depressed, power is Off. When the line is depressed, power is On.

### 3.4 DIODE/RESISTOR SENSOR INPUTS

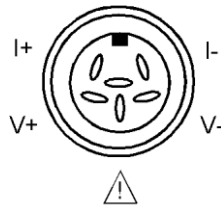
This section details how to connect diode and resistor sensors to the Model 325 inputs. Refer to Section 4.4 to configure the inputs. The optional thermocouple input is described in Section 3.5.

#### 3.4.1 Sensor Input Connector and Pinout

The input connectors are 6-pin DIN 45322 sockets. The sensor output pins are defined in Figure 3-3. Two mating connectors (6-pin DIN plugs) are included in the connector kit shipped with the instrument. These are common connectors, so additional mating connectors can be purchased from local electronics suppliers. They can also be ordered from Lake Shore (P/N 106-233).

**NOTE:** Pin 3 should not be used for new installations. However, to match existing Model 321, Model 330, or Model 340 connector wiring, the definition of Pin 3 may be changed with a jumper. See Figure 8-8 for jumper location.

To provide compatibility with sensor input connectors that have been wired for Lake Shore Models 321, 330 or 340 Temperature Controllers, Jumper 4 (for Input A) and Jumper 7 (for Input B) are used to select the function of Pin 3 of the connectors. The Model 321 and the Model 330 each provide a constant 1 mA sensor excitation current on Pin 3 and 10  $\mu$ A current on Pin 5. The Model 340 provides both 1 mA and 10  $\mu$ A excitation current on Pin 5 and connects Pin 3 to sensor ground reference. If the sensor being used was wired for use with a Model 321 or a Model 330, the jumper should be placed in the 321/ 330 position (factory default). This provides the output current selected via the front panel input setup function on both Pins 5 and 3. If the sensor was wired for use with a Model 340, the jumper should be placed in the 340 position. This provides the output current on Pin 5 only and connect Pin 3 to sensor ground reference.



<i>Pin</i>	<i>Symbol</i>	<i>Description</i>
1	I-	- Current
2	V-	- Voltage
3	⚠	+1 mA – Model 321/330 Configuration Shield – Model 340 Configuration
4	V+	+ Voltage
5	I+	+ Current
6	None	Shield

**Figure 3-3. Diode/Resistor Input Connector**

#### 3.4.2 Sensor Lead Cable

The sensor lead cable used outside the cooling system can be much different from what is used inside. Between the instrument and vacuum shroud, error and noise pick up, not heat leak, need to be minimized. Larger conductor, 22 to 28 AWG stranded copper wire is recommended because it has low resistance yet remains flexible when several wires are bundled in a cable. The arrangement of wires in a cable is also important. For best results, voltage leads, V+ and V- should be twisted together and current leads I+ and I- should be twisted together. The twisted pairs of voltage and current leads should then be covered with a braided or foil shield that is connected to the shield pin of the instrument. This type of cable is available through local electronics suppliers. Instrument specifications are given assuming 10 feet of sensor cable. Longer cables, 100 feet or more, can be used but environmental conditions may degrade accuracy and noise specifications. Refer to Section 2.3.6 for information about wiring inside the cryostat.

### 3.4.3 Grounding and Shielding Sensor Leads

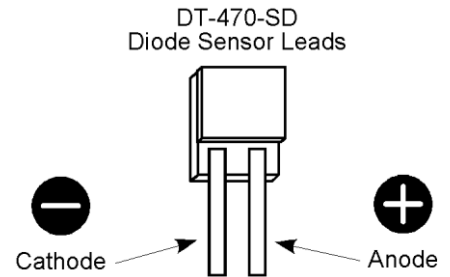
The sensor inputs are isolated from earth ground to reduce the amount of earth ground referenced noise that is present on the measurement leads. Connecting sensor leads to earth ground on the chassis of the instrument or in the cooling system will defeat that isolation. Grounding leads on more than one sensor prevents the sensor excitation current sources from operating.

Shielding the sensor lead cable is important to keep external noise from entering the measurement. A shield is most effective when it is near the measurement potential so the Model 336 offers a shield at measurement common. The shield of the sensor cable should be connected to the shield pin of the input connector. The shields should not be connected to earth ground on the instrument chassis. One shield should be connected to the cryostat's ground as long as it is near earth ground. Connecting at more than one point will cause a ground loop, which adds noise to the measurement.

**NOTE:** The shells of the input connectors are at the same potential as the shield pin on the Model 336. Older Lake Shore controllers are not configured this way.

### 3.4.4 Sensor Polarity

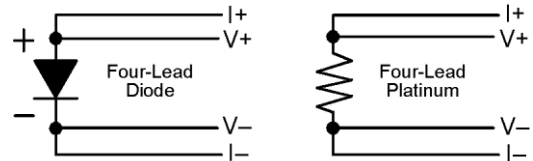
Lake Shore sensors are shipped with instructions that indicate which sensor leads are which. It is important to follow these instructions for plus and minus leads (polarity) as well as voltage and current when applicable. Diode sensors do not operate in the wrong polarity. They look like an open circuit to the instrument. Two lead resistors can operate with any lead arrangement and the sensor instructions may not specify. Four-lead resistors can be more dependent on lead arrangement. Follow any specified lead assignment for four lead resistors. Mixing leads could give a reading that appears correct but is not the most accurate.



### 3.4.5 Four-Lead Sensor Measurement

All sensors, including both two lead and four lead can be measured with a four lead technique. The purpose of a four lead measurement is to eliminate the effect of lead resistance on the measurement. If it is not taken out, lead resistance is a direct error when measuring a sensor.

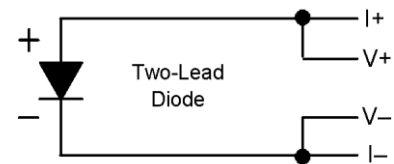
In a four-lead measurement, current leads and voltage leads are run separately up to the sensor. With separate leads there is little current in the voltage leads so their resistance does not enter into the measurement. Resistance in the current leads will not change the measurement as long as the voltage compliance of the current source is not reached. When two lead sensors are used in four lead measurements, the short leads on the sensor have an insignificant resistance.



### 3.4.6 Two-Lead Sensor Measurement

There are times when crowding in a cryogenic system forces users to read sensors in a two lead configuration because there are not enough feedthroughs or room for lead wires. If this is the case, plus voltage to plus current and minus voltage to minus current leads are attached at the back of the instrument or at the vacuum feedthrough.

The error in a resistive measurement is the resistance of the lead wire run with current and voltage together. If the leads contribute 2 or 3  $\Omega$  to a 10 k $\Omega$  reading, the error can probably be tolerated. When measuring voltage for diode sensors the error in voltage can be calculated as the lead resistance times the current, typically 10  $\mu$ A. For example: a 10  $\Omega$  lead resistance times 10  $\mu$ A results in a 0.1 mV error in voltage. Given the sensitivity of a silicon diode at 4.2 K the error in temperature would be only 3 mK. At 77 K the sensitivity of a silicon diode is lower so the error would be close to 50 mK. Again, this may not be a problem for every user.



### 3.4.7 Lowering Measurement Noise

Good instrument hardware setup technique is one of the least expensive ways to reduce measurement noise. The suggestions fall into two categories: (1) Do not let noise from the outside enter into the measurement, and (2) Let the instrument isolation and other hardware features work to their best advantage. Here are some further suggestions:

- Use 4-lead measurement whenever possible
- Do not connect sensor leads to chassis or earth ground
- Use twisted shielded cable outside the cooling system
- Attach the shield pin on the sensor connector to the cable shield
- Do not attach more than 1 cable shield at the other end of the cable
- Run different inputs and outputs in their own shielded cable
- Use twisted wire inside the cooling system
- Use similar technique for heater leads
- Use a grounded receptacle for the instrument power cord
- Consider ground strapping the instrument chassis to other instruments or computers.

### 3.5 THERMOCOUPLE SENSOR INPUTS (Model 325-TX Only)

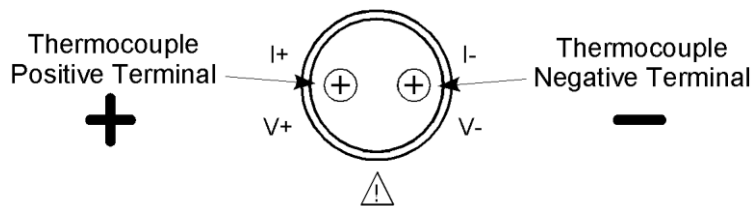
The information in this section is for a Model 325 configured at the factory with one or two thermocouple sensor inputs; being Model 325-T1 or -T2. Sensor connection is important when using thermocouples because the measured signal is small. Many measurement errors can be avoided with proper sensor installation.

**CAUTION:** Do not leave thermocouple inputs unconnected. Short inputs when not in use.

#### 3.5.1 Sensor Input Terminals

Attach sensor leads to the screws on the off-white ceramic terminal blocks. Each block has two screw terminals; one positive (on the I+/V+ side of the connector), one negative (on the I-/V- side of the connector). See Figure 3-4.

The current and voltage references silkscreened on the back panel are for the diode/resistor connectors. For thermocouples, the positive (+) wire goes to the left-side terminal and the negative (-) wire to the right-side terminal. Remove all insulation then tighten the screws on the thermocouple wires. Keep the ceramic terminal blocks away from heat sources including sunlight and shield them from fans or room drafts.



<i>Common Thermocouple Polarities</i>	<i>Positive (+)</i>	<i>Negative (-)</i>
Type K (Nickel-Chromium vs. Nickel-Aluminum)	Chromel (YEL)	Alumel (RED)
Type E (Nickel-Chromium vs. Copper-Nickel)	Chromel (PUR)	Constantan (RED)
Type T (Copper vs. Copper-Nickel)	Copper (BLU)	Constantan (RED)
Chromel-AuFe 0.03%	Chromel	Gold
Chromel-AuFe 0.07%	Chromel	Gold

**Figure 3-4. Thermocouple Input Definition and Common Connector Polarities**



### 3.5.2 Thermocouple Installation

Thermocouples are commonly used in high-temperature applications. Cryogenic use of thermocouples offers some unique challenges. A general installation guideline is provided in Section 2.3. Consider the following when using thermocouples at low temperatures:

- Thermocouple wire is generally more thermally conductive than other sensor lead wire. Smaller gauge wire and more heat sinking may be needed to prevent leads from heating the sample.
- Attaching lead wires and passing through vacuum tight connectors are often necessary in cryogenic systems. Remember, the thermocouple wire *is* the sensor; any time it joins or contacts other metal, there is potential for error.
- Temperature verification and calibration of room temperature compensation is difficult after the sensor is installed. When possible, keep a piece of scrap wire from each installation for future use.

### 3.5.3 Grounding and Shielding

For lowest measurement noise, do not ground thermocouple sensors. The instrument operates with more noise if one of the thermocouples is grounded. Grounding both thermocouples is not recommended. The instrument does not offer a shield connection on the terminal block. Twisting the thermocouple wires helps reject noise. If shielding is necessary, extend the shield from the oven or cryostat to cover the thermocouple wire, but do not attach the shield to the instrument.

## 3.6 HEATER OUTPUT SETUP

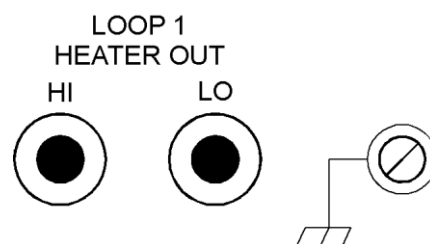
The following section covers the heater wiring from the vacuum shroud to the instrument for both control loop outputs. Specifications are detailed in Section 1.2. For help on choosing and installing an appropriate resistive heater, refer to Section 2.4.

### 3.6.1 Loop 1 Output

Of the two Model 325 control loops, Loop 1 is considered the primary loop because it is capable of driving 25 W of heater power. The heater output for Loop 1 is a traditional control output for a cryogenic temperature controller. It is a variable DC current source with software settable ranges and limits. The heater is configurable for optimization using either a 25  $\Omega$  or a 50  $\Omega$  heater resistance. At the 25  $\Omega$  setting, the maximum heater output current is 1 A and the compliance voltage is 25 V. At the 50  $\Omega$  setting, the maximum heater output current is 0.71 A and the compliance voltage is 35.4 V. Heater power is applied in one of two ranges: Low or High. At the Low range setting, the Loop 1 heater will output 10% of the High range power.

### 3.6.2 Loop 1 Heater Output Connector

A dual banana jack on the rear panel of the instrument is used for connecting wires to the Loop 1 heater. A standard dual banana plug mating connector is included in the connector kit shipped with the instrument. This is a common jack and additional mating connectors can be purchased from local electronic suppliers, or from Lake Shore (P/N 106-009). The heater is connected between the HI and LO terminals. The ground terminal is reserved for shielding the heater leads when necessary.



### 3.6.3 Loop 1 Heater Output Wiring

Heater output current is what determines the size (gauge) of wire needed to connect the heater. The maximum current that can be sourced from the Loop 1 heater output is 1 A. When less current is needed to power a cooling system it can be limited with range settings.

When setting up a temperature control system, the lead wire for the heater must be capable of carrying a continuous current that is greater than the maximum current. Wire manufactures recommend 30 AWG or larger wire to carry 1 A of current, but there is little advantage in using wire smaller than 20 to 22 AWG outside the cryostat. Inside the cryostat, smaller gauge wire is often desirable.

It is recommended to use twisted heater leads. Large changes in heater current can induce noise in measurement leads and twisting reduces the effect. It is also recommended to run heater leads in a separate cable from the measurement leads to further reduce interaction.

### **Loop 1 Heater Output Wiring (continued)**

There is a chassis ground point at the rear panel of the instrument for shielding the heater cable. The cable shield can be tied to this point using a #4 spade, or ring connector. The shield should not be connected at the opposite end of the cable and should never be tied to the heater output leads.

For best noise performance, do not connect the resistive heater or its leads to ground. Also avoid connecting heater leads to sensor leads or any other instrument inputs or outputs.

### **3.6.4 Loop 1 Heater Output Noise**

The heater output circuitry in the Model 325 must be capable of sourcing 25 W of power. This type of circuitry can generate some electrical noise. The Model 325 was designed to generate as little noise as possible but even noise that is a small percentage of the output voltage or current can be too much when sensitive measurements are being made near by. If the Model 325 heater leads are too noisy and the above wiring techniques do not help, Lake Shore offers the Model 3003 Heater Output Conditioner that may help. Refer to Section 7.4.

### **3.6.5 Loop 2 Output**

The Model 325 has a second control loop called Loop 2. Loop 2 is an auxiliary control loop with the capability of powering a small sample heater, or controlling a larger, programmable heater power supply. Loop 2 has a different output from Loop 1, it uses analog voltage output as its actuator. It is a variable DC voltage source with an output range from 0 V to +10 V. The output can source up to 200 mA of current providing a maximum of 2 W with a 50  $\Omega$  heater at the 50  $\Omega$  setting. The output voltage range is 0 V to +5 V when set to the 25  $\Omega$  setting, providing a maximum power of 1 W into a 25  $\Omega$  heater.

### **3.6.6 Loop 2 Output Resistance**

The power delivered by the Loop 2 output is calculated as:  $P = V^2 / R_{heater}$ . The output is rated for no more than 200 mA of current and has a built in current limit. For the maximum of 2 W output power use a 50  $\Omega$  resistive heater with a power rating greater than 2 W. A 25  $\Omega$  heater can be used to provide 1 W of power. The 25  $\Omega$  setting for Loop 2 changes the output voltage range to allow for control over the entire range of output. Using a 25  $\Omega$  heater at the 50  $\Omega$  setting would still provide 1 W of power, but the maximum power will be reached at a setting of about 50%, at which point the 200 mA current limit will begin to limit output power and could cause temperature control instability.

### **3.6.7 Loop 2 Output Connector**

The connector for the Loop 2 output is a 2 pin detachable terminal block. See Figure 8-5. Twisted pair of small gauge wire is recommended.

### **3.6.8 Loop 2 Heater Protection**

The output is short protected so the instrument is not harmed if the heater resistance is too small. It is not recommended because control over the full output voltage range is lost when in power limit mode. The user must be careful to build a robust system and account for the voltage range and power up state of the control output.

### **3.6.9 Boosting Output Power**

There are temperature control systems that require more power than the Model 325 can provide. An auxiliary DC power supply can be used to boost the output of the Model 325. Programmable power supplies are available that use a low current programming voltage as an input to control a high current voltage output. Loop 2 provides an ideal programming voltage for an auxiliary power supply.

The only drawback with using the Loop 2 output to program an auxiliary supply is that it has only one heater range. Although the heater resistance setting for Loop 2 does provide two different voltage scaling options (25  $\Omega$  setting: 0 to +5 V, 50  $\Omega$  setting: 0 to +10 V), the output resolution of each setting is the same. The heater output for Loop 1 has two ranges. Using the Low range will improve resolution, but the Loop 1 output is in current not voltage. To use Loop 1 to program a larger power supply, a programming resistor can be placed across the heater output to produce a programming voltage. The programming voltage is related to output current by:

$$V_{program} = R_{program} \times I_{output}$$

**Boosting Output Power (Continued)**

The resistor must be chosen to convert a full scale current from the highest heater output range being used to the full scale programming voltage of the auxiliary supply. For example, if the auxiliary supply has a full scale programming voltage of 10 V and the maximum current for the highest heater output range being used is 0.3 A the programming resistor should be  $10 \text{ V} / 0.3 \text{ A} = 33 \text{ } \Omega$ . The programming resistor must be rated for the power being dissipated in it, which is:

$$\text{Power} = I_{\text{output}}^2 \times R_{\text{program}}$$

or 3 W. The “Low” heater output range can be selected to reduce the power dissipated in the programming resistor.

**3.7 INITIAL SETUP AND SYSTEM CHECKOUT PROCEDURE**

The following is an initial instrument setup and checkout procedure. The intent is to verify basic operation of the unit before beginning use for measurements. The procedure assumes a setup with two Lake Shore DT-470 Silicon diode Sensors, one control loop, a single 50  $\Omega$  heater, all readings in kelvin, and running in a liquid nitrogen environment.

**CAUTION:** Check power source for proper voltage before connecting the line cord to the Model 325. Also check the line voltage setting on the window in the fuse drawer. Damage to unit may occur if connected to improper voltage.

1. Check power source for proper voltage. The Model 325 operates with 100, 120, 220, or 240 (+6%, -10%) AC input voltage.
2. Check window in fuse drawer for proper voltage setting. If incorrect, refer to Section 8.4.
3. Ensure the power switch is in the off (O) position.

**CAUTION:** The sensor must be connected to the rear of the unit before applying power to the Temperature Controller. Damage to the sensor may occur if connected with power on.

4. Verify your sensor installation in the liquid nitrogen environment. Then plug the control sensor connector in INPUT A and the sample sensor connector in INPUT B. Details of sensor hardware connections are detailed in Section 3.4.
5. Connect the heater to the banana jacks labeled HEATER OUTPUT. A 50  $\Omega$  heater allows the maximum power output of 25 W if the heater resistance setting is set to 50  $\Omega$ . A 25  $\Omega$  heater allows the maximum power output of 25 W if the heater resistance setting is set to 25  $\Omega$ . Details of heater installation are in Sections 2.4 and 3.6.
6. Ensure any other rear panel connections are connected before applying power to the unit. This includes the RS-232 (Section 6.2.1) and IEEE-488 (Section 8.7.2) connectors.
7. Plug line cord into receptacle.
8. Turn the power switch to the on (I) position. The front panel will briefly display the following.

```
Lake-Shore-Model -325
--Temp. -Controller
```

9. The typical display shown below will now appear.

```
A- 77.35k-B- 77.35k
S -0.000k-----0%-Off
```

The front panel display is divided into four areas. The default display settings place the Sensor A reading in the upper left, the Sensor B reading in the upper right, the Setpoint in the lower left, and the heater output of Loop 1 (in percent) in the lower right. All temperature readings are in kelvin. Each of these display areas is individually configurable by pressing the **Display Format** key and following the instructions in Section 4.3.

**Initial Setup and System Checkout Procedure (Continued)**

**NOTE:** For rated accuracy, the instrument should warm up for at least 30 minutes.

10. The default input settings are “Silicon Diodes” on Inputs A and B, with Input A controlling using the “Curve 01 DT-470.” These settings can be verified by pressing the **Input Setup** key and following the instructions in Section 4.4.
11. The default control mode is “Manual PID” where the Proportional, Integral, and Derivative (PID) settings are entered by the user. The default settings are P = 50, I = 20, and D = 0. These settings can be verified and/or adjusted by pressing the **PID/MHP** key and following the instructions in Section 4.8.
12. For an experiment running at liquid nitrogen temperature, a setpoint of 77 K is good for testing purposes. Press the **Setpoint** key. Press the “7” key twice, then press the **Enter** key. Details of setpoint setting are discussed in Section 4.11.

```

A- 77.35k-B- 75.35k
S 77.000k-----0%-Off
    
```

13. The default setting for the heater is “Off.” To turn the heater on, press the **Heater Range** key. Press the ▲ or ▼ key until “Low” is displayed. Press the **Enter** key. Depending on your actual setup, you may need to apply more current to the heater, which is accomplished by selecting the “High” range. Details of heater settings are discussed in Section 4.13.

```

A- 77.05k-B- 75.10k
S 77.000k-----50%-Low
    
```

**NOTE:** If any problems appear, immediately press the **Heater Off** key. If any error messages are displayed, refer to Section 8.11 for details.

The Model 325 should now be controlling the temperature in the experimental setup at the setpoint temperature. Once this initial checkout procedure is successfully completed, the unit is ready for normal operation. We recommend all users thoroughly read Chapter 4 – Operation before attempting to use the Model 325 in an actual experiment or application.

# CHAPTER 4

## OPERATION

### 4.0 GENERAL

This chapter provides instructions for the general operating features of the Model 325 Temperature Controller. Advanced operation is in Chapter 5. Computer interface instructions are in Chapter 6.

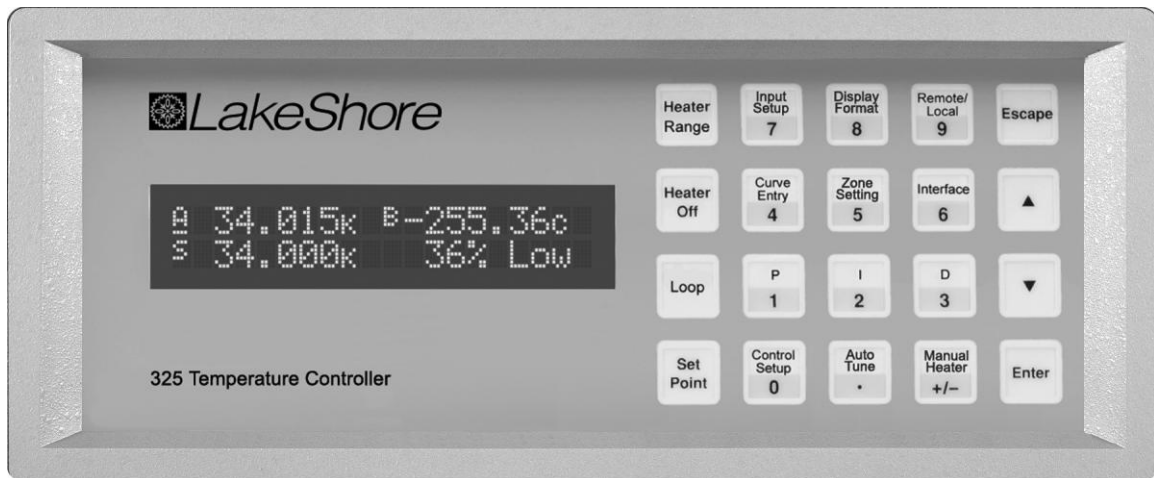
### 4.1 FRONT PANEL DESCRIPTION

This section provides a description of the front panel controls and indicators for the Model 325.

#### 4.1.1 Keypad Definitions

An abbreviated description of each key is provided as follows. A more detailed description of each function is provided in subsequent sections. See Figure 4-1.

- AutoTune** Allows selection of closed loop tuning mode: AutoTune PID, PI, P, Manual PID, or Zone for the currently selected loop. Refer to Section 4.9.
- Loop** Toggles the front panel display and key functions between Loop 1 and 2. Operates with: Control Setup, Setpoint, PID/MHP, Zone Settings, AutoTune, Heater Range, and Heater Off. Refer to Section 4.6.1.
- Heater Range** For Loop 1, allows selection of High (25 W) or Low (2.5 W) heater range. For Loop 2, allows selection of Heater On/Off. Refer to Section 4.13.
- Heater Off** Turns the heater off for Loop 1 or turns the control output off for Loop 2. Refer to Section 4.13.
- Control Setup** Allows selection of control input, setpoint units, closed or open loop control mode, power up enable, display of heater output units, setpoint ramp enable, ramp rate for the currently selected loop, and heater resistance. Refer to Section 4.7 for control setup and Section 4.12 for ramp feature.
- Setpoint** Allows entry of control setpoint for the currently selected loop. Refer to Section 4.11. A discussion of the ramp feature is provided in Section 4.12.
- Zone Settings** Allows entry of up to 10 temperature control zones of customer-entered PID settings and Heater Ranges for the currently selected loop. Refer to Section 4.10.



325-Front.bmp

Figure 4-1. Model 325 Front Panel

**Keypad Definitions (Continued)**

<b>P</b>	Allows manual adjustment of the Proportional control parameter for the currently selected loop. Refer to Section 4.8.1.
<b>I</b>	Allows manual adjustment of the Integral control parameter for the currently selected loop. Refer to Section 4.8.2.
<b>D</b>	Allows manual adjustment of the Derivative control parameter for the currently selected loop. Refer to Section 4.8.3.
<b>Manual Heater</b>	Allows adjustment of the Manual Heater Power setting. Refer to Section 4.8.4.
<b>Input Setup</b>	Allows selection of sensor input type and curve. Refer to Section 4.4 for sensor input setup and Section 4.5 for curve selection.
<b>Curve Entry</b>	Allows entry of up to fifteen 200-point CalCurves or user curves and SoftCal. Refer to Chapter 5 – Advanced Operation, Section 5.2 Front Panel Curve Entry Operations.
<b>Display Format</b>	Allows the user to configure the display and select the units or other source of the readings. Refer to Sections 4.1.4 and 4.3.
<b>Remote/Local</b>	Sets remote or local operation: Remote refers to operation is via IEEE-488 Interface; Local refers to operation via the front panel. Refer to Section 4.16.
<b>Interface</b>	Sets the baud rate of the serial interface and IEEE-488 address and terminators. Refer to Section 4.17.
<b>▲</b>	Serves two functions: chooses between parameters during setting operations and to increment a numerical parameter value.
<b>▼</b>	Serves two functions: chooses between parameters during setting operations and decrements numerical parameter value.
<b>Escape</b>	Terminates a setting function without changing the existing parameter value. Press and hold to reset instrument to default values. Refer to Section 4.18.
<b>Enter</b>	Completes setting functions and returns to normal operation. Press and hold to lock or unlock keypad. Refer to Section 4.15.
<b>0–9, +/–, .</b>	Used for entry of numeric data. Includes a key to toggle plus (+) or minus (–), and a key for entry of a decimal point. Refer to Section 4.1.3.

**4.1.2 Annunciators**

Display annunciators are listed as follows:

A or <u>A</u> ... Sensor Input A	K..... Temperature in kelvin	Ω..... Sensor units of ohms
B or <u>B</u> .... Sensor Input B	C..... Temperature in degrees Celsius	mV..... Sensor units of millivolts
S ..... Setpoint	V..... Sensor units of volts	R ..... Remote

If a displayed sensor input channel is being used to control the currently selected Loop, the display annunciator for that sensor input will be underlined. Refer to Section 4.4.

**4.1.3 General Keypad Operation**

There are three basic keypad operations: Direct Operation, Setting Selection, and Data Entry.

**Direct Operation.** The key function occurs as soon as the key is pressed, e.g., Loop, Heater Off, and Remote/Local.

**Setting Selection.** Allows the user to select from a list of values. During a selection sequence the **▲** or **▼** key are used to select a parameter value. After a selection is made the **Enter** key is pressed to make the change and advance to the next setting, or the **Escape** key is pressed to return to the normal display without changing the present setting. The instrument retains any values entered prior to pressing the **Escape** key. Some selections are made immediately after pressing a

**General Keypad Operation (Continued)**

function key; like Heater Range. Most are part of a string of settings. Setting selections always include the “Select for ... ▲▼” display, a sample of which is shown below.

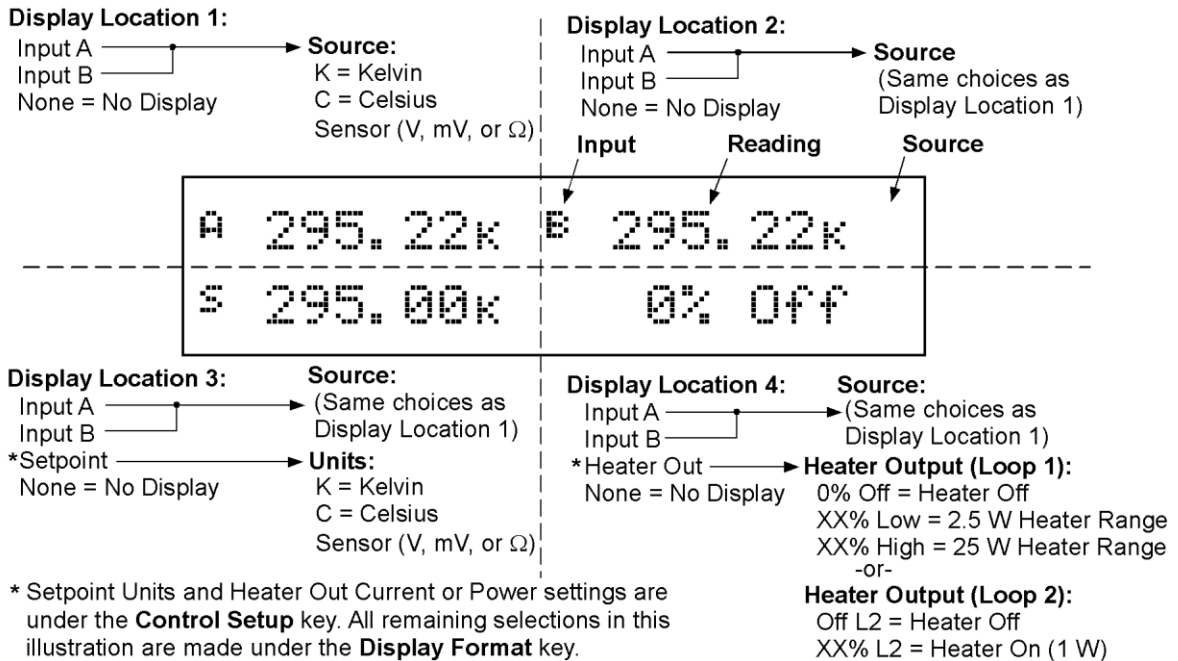


**Data Entry.** Allows the user to enter number data using the data entry keys. Data entry keys include the numbers 0–9, +/-, and decimal point. Proportional control parameter is an example of a parameter that requires data entry. During a data entry sequence use the data entry keys to enter the number value, press the **Enter** key to accept the new data and advance to the next setting. Press the **Escape** key once to clear the entry, twice to return to the normal display. Most data entry operations are combined with other settings and grouped under a function key. Temperature or sensor unit parameters have the same setting resolution as the display resolution for their corresponding readings. Data entry always includes the “Enter for ...” display, a sample of which is shown below.



**4.1.4 Display Definition**

In normal operation, the 2-row by 20-character LCD display is divided into four user-configurable areas that can provide temperature readings, setpoint display, and heater status. Other information is displayed when using the various functions on the keypad. See Figure 4-2.



\* Setpoint Units and Heater Out Current or Power settings are under the **Control Setup** key. All remaining selections in this illustration are made under the **Display Format** key.

C-325-4-2.bmp

**Figure 4-2. Display Definition**

## 4.2 TURNING POWER ON

After verifying line voltage (Section 3.3), plug the instrument end of the line cord (included with the connector kit) into the power and fuse assembly receptacle on the instrument rear. Plug the opposite end of the line cord into a properly grounded, three-prong receptacle. Place the power switch, located next to the line cord receptacle, to the On (I) position. The instrument initiates the following power up sequence: the instrument alarm sounds once; the display shows the following startup message.

```

Lake Shore Model 325
Temp. Controller
    
```

The normal reading display appears. If the instrument does not complete the sequence or if a general error message displays, there may be a problem with the line power or the instrument. Individual messages in a reading location normally indicate that input setup is required.

## 4.3 DISPLAY FORMAT AND SOURCE (UNITS) SELECTION

In the normal display, the display is divided into four user-configurable areas that can provide temperature readings, setpoint display, and heater status. Figure 4-3 illustrates the display location numbering and available selections for each location. To change Setpoint units and select Heater Out Power or Current, refer to the description of **Control Setup** in Section 4.7.

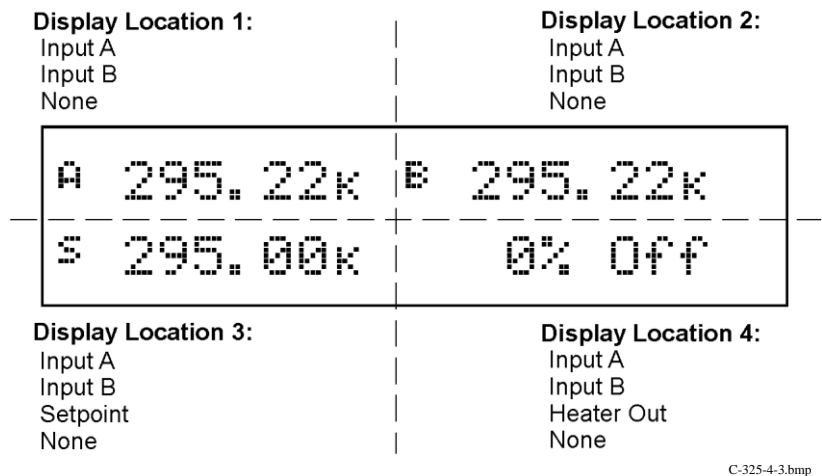


Figure 4-3. Display Format Definition

To configure a display location, press the **Display Format** key to display the following screen.

```

Select With ▲▼
Display Location 1
    
```

Use the ▲ or ▼ key to increment or decrement through Display Locations 1 through 4. For this example, select Display Location 1, then press the **Enter** key. You will see the following display

```

Select for Disp 1 ▲▼
Display Input A
    
```



**Display Format And Source (Units) Selection (Continued)**

Use the ▲ or ▼ key to cycle between Input A, Input B, or None. For this example, select Input A then press the **Enter** key. You will see the following display

```

Select for Disp 1 ▲▼
Source Temp K
    
```

Use the ▲ or ▼ key to cycle through the following data sources: Temp K, Temp C, Sensor. For this example, select Temp K then press the **Enter** key.

**NOTE:** The sensor reading of the instrument can always be displayed in sensor units. If a temperature response curve is selected for an input, its readings may also be displayed in temperature.

With the settings from the previous example, Display Location 1 will resemble the following.

```

A 295.22k
    
```

The process is the same for the other three display locations. However, additional choices are provided for Display Location 3 and 4, being Setpoint and Heater Out respectively.

In the following example, we will setup Display Location 3 to show the setpoint. Press the **Display Format** key.

```

Select With ▲▼
Display Location 3
    
```

Use the ▲ or ▼ key to increment or decrement through Display Locations 1 through 4. For this example, select Display Location 3, then press the **Enter** key. You will see the following display

```

Select for Disp 3 ▲▼
Display Setpoint
    
```

Use the ▲ or ▼ key to cycle between Input A, Input B, Setpoint, or None. For this example, select Setpoint then press the **Enter** key.

With the settings from the previous example, and assuming you setup Display Location 1 detailed above, the display will resemble the following.

```

A 295.22k B 295.22k
S 0.000k
    
```

To change the setpoint units, refer to Control Setup, Section 4.7.

#### 4.4 INPUT SETUP

The Model 325 supports a variety of temperature sensors sold by Lake Shore and other manufacturers. An appropriate sensor type must be selected for each of the two inputs. If the exact sensor model is not shown, use the sensor input performance chart in Table 4-1 to choose an input type with similar range and excitation. For additional details on sensors, refer to the Lake Shore Temperature Measurement and Control Catalog or visit our website at [www.lakeshore.com](http://www.lakeshore.com).

**Table 4-1. Sensor Input Types**

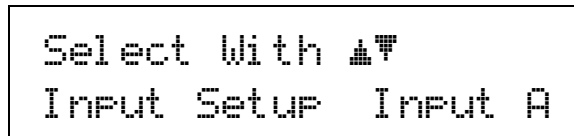
Display Message	Input Range	Excitation	Sensor Type	Curve Format	Coefficient	Lake Shore Sensors*
Silicon Diode	2.5 V	10 $\mu$ A	Silicon Diode	V/K	Negative	DT-4XX, DT-500, DT-670 Series
GaAlAs Diode	7.5 V	10 $\mu$ A	Gallium-Aluminum-Arsenide Diode	V/K	Negative	TG-120 Series
100 $\Omega$ Plat/250	250 $\Omega$	1 mA	100 $\Omega$ Platinum RTD <675 K; Rhodium-Iron RTD	$\Omega$ /K	Positive	PT-100 Series Platinum, RF-800 Rhodium-Iron
100 $\Omega$ Plat/500	500 $\Omega$	1 mA	100 $\Omega$ Platinum RTD >675 K			
1000 $\Omega$ Plat	5000 $\Omega$	1 mA	1000 $\Omega$ Platinum RTD	$\Omega$ /K	Positive	—
NTC RTD	7500 $\Omega$	10 $\mu$ A	Negative Temperature Coefficient (NTC) RTD	log R/K	Negative	Cernox™, Carbon Glass, Germanium, Rox™, and Thermox™
Thermo/25mV	$\pm$ 25 mV	NA	Thermocouple	mV/K	Positive	Chromel-AuFe (0.07%), Type E (Chromel-Constantan), Type K (Chromel-Alumel), Type T (Copper-Constantan),
Thermo/50mV	$\pm$ 50 mV	NA	Thermocouple			

\* Refer to the Lake Shore Temperature Measurement and Control Catalog for details on Lake Shore temperature sensors.

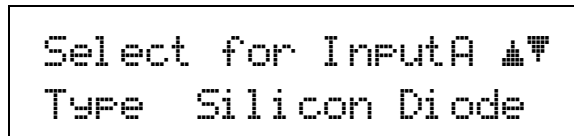
##### 4.4.1 Diode Sensor Input Setup – 10 $\mu$ A Excitation Current

Diode sensors include the Silicon and Gallium-Aluminum-Arsenide (GaAlAs) detailed in Table 4-1. More detailed specifications are provided in Section 1.2. Input ranges are fixed to 0–2.5 V for silicon diodes and 0–7.5 V for GaAlAs diodes. Both use a sensor excitation current of 10  $\mu$ A.

To setup a diode sensor input, press the **Input Setup** key. The first screen appears as follows.



Use the **▲** or **▼** key to toggle between Input A and B. Press the **Enter** key.



Use the **▲** or **▼** key to cycle through the sensor types shown in Table 4-1, with “Silicon Diode” and “GaAlAs Diode” being the relevant choices. Press the **Enter** key. Proceed to Section 4.5.1 to select a temperature curve or press the **Escape** key to return to the normal display.

##### 4.4.2 Diode Sensor Input Setup – 1 mA Excitation Current

As an alternative to the standard diode input configuration listed in Section 4.4.1, the user may select 1 mA excitation while the input configuration matches the diode input setup as detailed in Table 4-1. Input ranges are fixed to 0–2.5 V and 0–7.5 V.

**Diode Sensor Input Setup – 1 mA Excitation Current (Continued)**

To access the alternative setup, the diode current must be set to 1 mA. Press and hold the **Input Setup** key for 10 seconds to display the screen shown as follows:

```
Select for InputA ▲▼
Diode Current 1mA
```

Use the ▲ or ▼ key to toggle between 10  $\mu$ A and 1 mA to select the diode current for Input A. 1 mA must be selected for the special sensor input to be available for Input A. Press the **Enter** key.

```
Select for InputB ▲▼
Diode Current 1mA
```

Use the ▲ or ▼ key to toggle between 10  $\mu$ A and 1 mA to select the diode current for Input B. 1 mA must be selected for the special sensor input to be available for Input B. Press the **Enter** key.

To setup the diode input using 1 mA excitation, press the **Input Setup** key. The first screen appears as follows.

```
Select With ▲▼
Input Setup Input A
```

Use the ▲ or ▼ key to toggle between Input A and B. Press the **Enter** key.

```
Select for InputA ▲▼
Type 2.5V, 1mA
```

Use the ▲ or ▼ key to cycle through the sensor types shown in Table 4-1, with “2.5V, 1mA” and “7.5V, 1mA” being the relevant choices. Press the **Enter** key. Proceed to Section 4.5.1 to select a temperature curve or press the **Escape** key to return to the normal display.

**4.4.3 Resistor Sensor Input Setup**

Resistor sensors include the Platinum, Rhodium-Iron, and various NTC RTD sensors (e.g., Cernox, Rox, Thermox) detailed in Table 4-1. More detailed specifications are provided in Table 1-2. Input range is fixed to type of sensor. The excitation current applied by the Model 325 is determined by the user selection of Negative Temperature Coefficient (NTC) = 10  $\mu$ A or Positive Temperature Coefficient (PTC) = 1 mA.

To setup a resistor sensor input, press the **Input Setup** key. The first screen appears as follows.

```
Select With ▲▼
Input Setup Input A
```

Use the ▲ or ▼ key to toggle between Input A and B. Press the **Enter** key.

```
Select for InputA ▲▼
Type NTC RTD
```

Use the ▲ or ▼ key to cycle through the sensor types shown in Table 4-1, with “100 $\Omega$  Plat/250,” “100 $\Omega$  Plat/500,” “1000 $\Omega$  Plat,” and “NTC RTD” being the relevant choices. Press the **Enter** key.

#### 4.4.3.1 Thermal EMF Compensation

To keep power low and avoid sensor self heating, the sensor excitation is kept low. There are two major problems that occur when measuring the resulting small DC voltages. The first is external noise entering the measurement through the sensor leads, which is discussed with sensor setup. The second problem is the presence of thermal EMF voltages, sometimes called thermocouple voltages, in the lead wiring. Thermal EMF voltages appear whenever there is a temperature gradient across a piece of voltage lead. Thermal EMF voltages must exist because the sensor is almost never the same temperature as the instrument. They can be minimized by careful wiring, making sure the voltage leads are symmetrical in the type of metal used and how they are joined, and by keeping unnecessary heat sources away from the leads. Even in a well-designed system thermal EMF voltages can be an appreciable part of a low voltage sensor measurement.

The Model 325 can help with a thermal correction algorithm. The instrument will automatically reverse the polarity of the current source every other reading. The average of the positive and negative sensor readings will cancel the thermal EMF voltage that is present in the same polarity, regardless of current direction.

To turn reversal on or off press the **Input Setup** key and press the **Enter** key until the following display appears.

```
Select for InputA ▲▼
Reversal Off
```

Resistor sensors have the additional choice of turning current reversal On or Off, with the default being On. If turned On, the Model 325 will automatically reverse the polarity. Press the **Enter** key.

Proceed to Section 4.5.2 to select a temperature curve or press the **Escape** key to return to the normal display.

#### 4.4.4 Thermocouple Sensor Input Setup (Model 325-TX only)

The following thermocouple screens are only displayed when the Model 325 hardware is configured at the factory with one or two thermocouple sensor inputs; being Model 325-T1 or T2.

The user has the choice of two different input voltage ranges:  $\pm 25$  mV and  $\pm 50$  mV. The  $\pm 25$  mV range is recommended for cryogenic applications or higher temperatures less than 500 K. Since thermocouple voltage can exceed 25 mV on some thermocouple types, the  $\pm 50$  mV range is recommended for temperatures above 500 K.

The voltage range for Inputs A and B is set independently. To setup a thermocouple sensor input, press the **Input Setup** key. The first screen appears as follows.

```
Select With ▲▼
Input Setup Input A
```

Use the **▲** or **▼** key to toggle between Input A and B. Press the **Enter** key.

```
Select for InputA ▲▼
Type Thermo/25mV
```

Use the **▲** or **▼** key to cycle through the sensor types shown in Table 4-1, with “Thermo/25mV” and “Thermo/50mV” being the relevant choices. Press the **Enter** key. Proceed to Section 4.4.4.1 to select a room-temperature compensation or press the **Escape** key to return to the normal display.

#### 4.4.4.1 Room-Temperature Compensation

Room-temperature compensation is required to give accurate temperature measurements with thermocouple sensors. It corrects for the temperature difference between the instrument thermal block and the curve normalization temperature of 0 °C. An external ice bath is the most accurate form of compensation, but is often inconvenient. The Model 325 has built-in room-temperature compensation that is adequate for most applications. The built-in compensation can be turned on or off by the user. It operates with any thermocouple type that has an appropriate temperature response curve loaded. Room-temperature compensation is not meaningful for sensor units measurements.

**NOTE:** Room temperature compensation should be calibrated as part of every installation.

To turn room temperature compensation on or off, press the **Input Setup** and press **Enter** until the following display appears.

```
Select for InputA ▲▼
Room Comp On
```

Use the ▲ or ▼ key to turn room-temperature compensation on or off, then press the **Enter** key. The default setting is On. If curve is set to “None” the room-temperature compensation selection is automatically turned off.

#### 4.4.4.2 Room-Temperature Calibration Procedure

Room-temperature calibration is used to calibrate the built-in compensation and is recommended when a thermocouple is first installed or any time a thermocouple is changed.

Factory calibration of the instrument is accurate to within approximately  $\pm 1$  K. Differences in thermocouple wire and installation technique create errors greater than the instrument errors.

Therefore, the best accuracy is achieved by calibrating with the thermocouple actually being used because it eliminates all sources of error. If that is not possible, use a thermocouple made from the same wire. For less demanding applications, a short across the input terminals will suffice. If the Model 325 is configured as dual thermocouple unit, calibrate both inputs even if they use the same type of thermocouple. An appropriate curve must be selected and room temperature compensation must be turned on before calibration can be started.

There are three options for room temperature calibration:

- **Cleared.** The previous room-temperature calibration value is cleared and no adjustment will be made to the temperature value provided by the internal temperature sensor when compensation is on.
- **No.** Use the room-temperature calibration value determined the last time the room-temperature calibration procedure was performed.
- **Yes.** Perform the room-temperature calibration procedure that follows.

##### *Calibration Procedure*

1. Attach a thermocouple sensor or direct short across the input terminals of the thermocouple input. See Figure 3-4 for polarity.
2. Place the instrument away from drafts. If calibrating using a short, place an accurate room-temperature thermometer near the terminal block.
3. Allow the instrument to warm up for at least ½ hour without moving or handling the sensor.
4. If calibrating with a short skip to step 6, otherwise insert the thermocouple into the ice-bath, liquid nitrogen, helium Dewar, or other known fixed temperature. The temperature should be close to the measurement temperature that requires best accuracy.
5. Read the displayed temperature. If the temperature display is not as expected, check to be sure that the thermocouple is making good thermal contact. If possible, add a thermal mass to the end of the thermocouple.
6. Press the **Input Setup** key and press the Enter key until the “Room Cal” screen appears. Press the ▲ or ▼ key until the “Yes” selection appears then press the **Enter** key.

```
Select for InputA ▲▼
Room Cal Yes
```

**Room-Temperature Calibration Procedure (Continued)**

7. The current temperature reading is displayed in kelvin.

```
Select for Input A
Temp          294.15k
```

Enter the true temperature that the thermocouple should read. If input is shorted, then enter the actual room temperature measured by the thermometer. Press the **Enter** key to save the value.

8. To verify calibration, check that the temperature reading for the calibrated input matches the room-temperature calibration setting value.

**4.4.5 Temperature Limit (Firmware Version 1.5 and Later)**

The temperature limit feature provides a means of protecting your equipment from damage by shutting down all control outputs when the assigned temperature limit is exceeded on any sensor input. The feature is available for both of the sensor inputs. A temperature limit of 0 K (default value) turns this feature off. This feature was added in firmware version 1.5. If you need a firmware update, contact service (section 8.1). Section 4.18 provides the procedure to check your firmware version.

To configure a temperature limit press the **Input Setup** key. The first screen appears as follows.

```
Select With ▲▼
Input Setup Input A
```

Use the **▲** or **▼** key to toggle between Input A and B. Press the **Enter** key until the following display appears.

```
Enter for Input A
Temp Limit      0K
```

The temperature limit is entered using the numeric keypad, which includes the numbers 0 – 9. The user can set temperature limit in kelvin with a range of 0 to 2999 and a resolution of 1. The feature is turned off when a temperature limit of 0 K is entered. Press the **Enter** key to save the value.

**4.5 CURVE SELECTION**

The Model 325 supports a variety of temperature sensors sold by Lake Shore and other manufacturers. After the appropriate sensor type is selected for each of the two inputs (Section 4.4), an appropriate curve may be selected for each input. The 325 can use curves from several sources. Standard curves are included with every instrument and numbered 1 – 20. User curves, numbered 21 – 35, are loaded when a sensor does not match a standard curve. CalCurve options are stored as user curves. SoftCal calibrations are stored as user curves or user can enter their own curves from the front panel (Section 5.2) or computer interface (Chapter 6). The complete list of sensor curves built in to the Model 325 is provided in Table 4-2.

During normal operation, only the curves related to the input type you have selected are displayed. If the curve you wish to select does not appear in the selection sequence make sure the curve format matches the recommended format for the input type selected. Refer to Table 4-1.

**NOTE:** The sensor reading of the instrument can always be displayed in sensor units. If a temperature response curve is selected for an input, its readings may also be displayed in temperature.

Table 4-2. Sensor Curves

<i>Curve Number</i>	<i>Display</i>	<i>Sensor Type</i>	<i>Model Number</i>	<i>Temperature Range</i>	<i>For Data Points, Refer To:</i>
01	DT-470	Silicon Diode	DT-470	1.4–475 K	Table D-1
02	DT-670	Silicon Diode	DT-670	1.4–500 K	Table D-2
03	DT-500-D*	Silicon Diode	DT-500-D	1.4–365 K	Table D-3
04	DT-500-E1*	Silicon Diode	DT-500-E1	1.1–330 K	Table D-3
05	Reserved	–	–	–	–
06	PT-100	100Ω Plat/250 100Ω Plat/500	PT-100	30–800 K	Table D-4
07	PT-1000*	1000Ω Plat	PT-1000	30–800 K	Table D-4
08	RX-102A-AA	NTC RTD	Rox RX-102A	0.05–40 K	Table D-5
09	RX-202A-AA	NTC RTD	Rox RX-202A	0.05–40 K	Table D-6
10	Reserved	–	–	–	–
11	Reserved	–	–	–	–
12	Type K	Thermo/25mV and 50mV	Type K	3–1645 K	Table D-7
13	Type E	Thermo/25mV and 50mV	Type E	3–1274 K	Table D-8
14	Type T	Thermo/25mV and 50mV	Type T	3–670 K	Table D-9
15	AuFe 0.03%*	Thermo/25mV and 50mV	AuFe 0.03%*	3.5–500 K	Table D-10
16	AuFe 0.07%	Thermo/25mV and 50mV	AuFe 0.07%	3.15–610 K	Table D-11
17	Reserved	–	–	–	–
18	Reserved	–	–	–	–
19	Reserved	–	–	–	–
20	Reserved	–	–	–	–
21–35	User Curves	–	–	–	–

\* No longer sold by Lake Shore.

#### 4.5.1 Diode Sensor Curve Selection

Once the input is setup for the Silicon or Gallium-Aluminum-Arsenide diode (Section 4.4.1), you may choose a temperature curve, standard curve numbers 1 through 4 being relevant choices. You are also given the choice of “None.” You may also choose from any appropriate User Curves stored in Curve Numbers 21 through 36. Data points for standard diode curves are detailed in Tables D-1 through D-3 in Appendix D.

Press the **Input Setup** key. Press the **Enter** key until you see the curve selection screen shown below.

```
Select for InputA ▲▼
Curve 01 DT-470
```

Use the ▲ or ▼ key to cycle through the sensor curves until the desired curve is displayed. Press the **Enter** key, then the **Escape** key to return to the normal display.

#### 4.5.2 Resistor Sensor Curve Selection

Once the input is setup for the Platinum, Rhodium-Iron, or various NTC RTD sensors (Section 4.4.3), you may choose a temperature curve. Standard curve numbers 6 and 7 being relevant to Platinum, or curves 8 and 9 being relevant to Rox sensors. You are also given the choice of "None." You may also choose from any appropriate User Curves stored in Curve Numbers 21 through 35. Data points for resistor curves are detailed in Tables D-4 through D-6 in Appendix D.

Press the **Input Setup** key. Press the **Enter** key until you see the curve selection screen shown below.

```
Select for InputA ▲▼
Curve 08 RX-102A-AA
```

Use the ▲ or ▼ key to cycle through the sensor curves until the desired curve is displayed. Press the **Enter** key, then the **Escape** key to return to the normal display.

#### 4.5.3 Thermocouple Sensor Curve Selection

The following thermocouple screens are only displayed when the Model 325 hardware is configured at the factory with one or two thermocouple sensor inputs; being Model 325-T1 or -T2.

Once the input is setup for the thermocouple input voltage (Section 4.4.4), you may choose a temperature curve. Press the **Input Setup** key. Standard curve numbers 12 through 16 being relevant. You are also given the choice of "None." You may also choose from any appropriate User Curves stored in Curve Numbers 21 through 35. Data points for thermocouple curves are detailed in Tables D-7 through D-11 in Appendix D. Press the **Enter** key until you see the curve selection screen shown below.

```
Select for InputA ▲▼
Curve 16 AuFe 0.07%
```

Use the ▲ or ▼ key to cycle through the sensor curves until the desired curve is displayed. Press the **Enter** key, then the **Escape** key to return to the normal display.

#### 4.5.4 Filter

The reading filter applies exponential smoothing to the sensor input readings. If the filter is turned on for a sensor input, all reading values for that input are filtered. The filter is a running average so it does not change the update rate of an input. Filtered readings are used for displayed readings only, not for control functions.

The number of filter points determines how much smoothing is done. One filter point corresponds to one new reading on that input. A larger number of points does more smoothing but also slows the instruments response to real changes in temperature. The default number of filter points is 8, which settles in approximately 50 readings or 5 seconds.

The filter window is a limit for restarting the filter. If a single reading is different from the filter value by more than the limit the instrument will assume the change was intentional and restart the filter. Filter window is set in percent of full-scale range.

To configure a filter press the **Input Setup** key. The first screen appears as follows.

```
Select With ▲▼
Input Setup Input A
```

Use the ▲ or ▼ key to toggle between Input A and B. Press the **Enter** key until the following display appears.

```
Select for InputA ▲▼
Filter On
```



**Filter (Continued)**

Use the ▲ or ▼ key to toggle between Filter On and Off. If you select Off, the routine will end and return you to the normal display. If you select On, the routine will continue with the following.

```
Select for InputA ▲▼  
Filter Points 08
```

Use the ▲ or ▼ key to increment or decrement the Filter Points from 02 through 64, with 08 being the default. Press the **Enter** key. You will see the following display.

```
Select for InputA ▲▼  
Filter Window 01%
```

Use the ▲ or ▼ key to increment or decrement the Filter Window from 01% through 10%, with 01% being the default. Press the **Enter** key. You will return to the normal display.

## 4.6 TEMPERATURE CONTROL

There are many steps involved in setting up a temperature control loop. Chapter 2 of this manual describes the principals of closed loop (feedback) control. Chapter 3 describes necessary hardware installation. The following sections of this chapter describe how to operate the control features and set control parameters. Each control parameter should be considered before enabling a control loop or the instrument may not be able to perform the most simple control functions. A good starting point is deciding which control loop to use, whether to operate in open or closed control mode and which tuning mode is best for the application. Other parameters fall into place once these have been chosen.

### 4.6.1 Control Loops

The Model 325 is capable of running two simultaneous control loops. Their capabilities are compared in Table 4-3. As shown there the primary difference between the two loops is their control output.

**Loop 1:** Loop 1, the primary control loop, is the traditional control loop for a cryogenic temperature controller. It includes the largest set of hardware and software features making it very flexible and easy to use. Loop 1 uses the heater output as its control output. The heater output is a well-regulated 25 W DC output with two power ranges. This provides quiet, stable control for a broad range of temperature control systems in a fully integrated package.

**Loop 2:** Loop 2, the auxiliary control loop, shares most of the operational features of loop 1 but uses the 2W, 10 V output as its control output. By itself, Loop 2 is capable of driving a sample heater or other low power load. It is also suited to drive the programming input of a voltage programmable power supply. In combination the controller and supply can be used to control large loads at high temperatures.

The keypad and display operate on one loop at a time. To toggle display and keypad operation between Loop 1 and Loop 2 press the **Loop** key. A brief display message indicates which control loop has been selected. You can determine which loop is active by looking at the heater output display. Loop 1 has “Low” or “High” in the heater display. Loop 2 has “L2” in the heater display. Also, when you select any of the following parameters, the active loop number will be displayed: Control Setup, Setpoint, P, I, D, Manual Heater, Zone Settings, AutoTune, and Heater Range.

**Control Loops (Continued)****Table 4-3. Comparison of Control Loops 1 and 2**

Feature	Loop 1	Loop 2
Maximum Output Power	25 W	2 W
Output Type	Current Source	Voltage Source
Multiple Output Ranges	Yes	No
Closed Loop PID Control	Yes	Yes
AutoTune	Yes	Yes
Zone Tuning	Yes	Yes
Ramping	Yes	Yes
Open Loop Control	Yes	Yes
Front Panel Display	Yes	Yes
Setpoint Limit	Yes	Yes

**4.6.2 Control Modes**

The Model 325 offers two control modes, closed loop and open loop. To select a control mode refer to Section 4.7.

**Closed Loop Control:** Closed loop control, often called feedback control, is the control mode most often associated with temperature controllers. In this mode the controller attempts to keep the load at exactly the user entered setpoint temperature. To do this, it uses feedback from the control sensor to calculate and actively adjust the control output or heater setting. The Model 325 uses a control algorithm called PID that refers to the three terms used to tune the controller for each unique system. Manual heater power output can also be used during closed loop control. Closed loop control is available for both control loops and offers several methods of tuning.

**Open Loop Control:** Open loop control is less complicated than closed loop control but is also less powerful. Open loop control mode allows the user to directly set the manual heater power output for Loop 1 and Loop 2, using only the Manual Heater Power (MHP) parameter. During Open Loop control only the heater range and MHP Output parameters are active, the setpoint, control sensor and PID parameters are ignored. This type of control guarantees constant power to the load but it does not actively control temperature. Any change in the characteristics of the load will cause a change in temperature. Closed loop control is available for both loops and no tuning is required.

**4.6.3 Tuning Modes**

The Model 325 offers three tuning modes or ways to set the necessary P, I and D parameters for closed loop control. MHP output is active during closed loop control and must be set to zero if not wanted. Heater range must also be considered as part of tuning when using control Loop 1.

**Manual PID Tuning:** Manual tuning is the most basic tuning method. The user manually enters parameter values for P, I, D, and heater range using their knowledge of the cooling system and some trial and error. Refer to Sections 2.7 and 4.8 for guidelines. Manual tuning can be used in any situation within the control capabilities of the instrument.

**AutoTune:** The Model 325 automates the tuning process with an AutoTune algorithm. This algorithm measures system characteristics after a setpoint change and calculates P, I and D. The user must set heater range. AutoTune will not work in every situation. Refer to Sections 2.8 and 4.9 for details.

**Zone Tuning:** Optimal control parameters values are often different at different temperatures within a system. Once values have been chosen for each temperature range or zone, the zone feature can automatically select the correct set each time the setpoint is changed. This mode does not help choose control parameter values; it helps use the values more efficiently. Refer to Sections 2.7 and 4.10 for details.

## 4.7 CONTROL SETUP

After the Input Setup has been completed (Section 4.4) and Loop is selected (Section 4.6.1), the user can begin to setup temperature control parameters.

Control input is the sensor input that is used for control feedback in closed loop control. Either Input A or B can be assigned to either Loop 1 or 2. It is not recommended to assign both loops to one input. Control input is ignored when using open loop control mode. To change control input, press the **Control Setup** key and the following screen will appear.

```
Select for Loop 1 ▲▼  
Control with Input A
```

Use the ▲ or ▼ key to toggle between Input A and B. Press the **Enter** key to accept the setting and continue with additional selections. You can press the **Escape** key any time to exit the routine.

The control setpoint can be displayed and set in temperature or sensor units. Changing setpoint units does not change operation of the controller, only the way the setpoint is displayed and entered. A valid curve must be assigned to the control input to use temperature units. To change setpoint units press the **Control Setup** key and press **Enter** until the following display appears.

```
Select for Loop 1 ▲▼  
SP Units Temp K
```

Use the ▲ or ▼ key to cycle through the following setpoint units: Temp K, Temp C, and Sensor, where K = kelvin, C = degrees Celsius, and Sensor = volts (V), millivolts (mV), or ohms ( $\Omega$ ). Press the **Enter** key.

The Model 325 has two control modes, Closed Loop and Open Loop. Closed Loop control, often called feedback control, is described in Section 2.6 of this manual. During closed loop control operation, the Control Input, Setpoint, Heater Range, PID, and Manual Heater Power (MHP) output parameters are active. Open loop control mode allows the user to directly set the heater output for Loop 1 or Loop 2 with the MHP Output parameter. During Open Loop control only the heater range and MHP Output parameters are active. To change Control Mode press the **Control Setup** key and press **Enter** until the following display appears.

```
Select for Loop 1 ▲▼  
Control Mode Closed
```

Use the ▲ or ▼ key to toggle between open and closed loop control. Press the **Enter** key.

The Power Up setting refers to how the control output will respond after the instrument is powered down. Power Up Enable means the controller will power up with the control output in the same state it was before power was turned off. Power Up Disable means the controller will always power up with the heater off no matter how it was set when power was turned off. To change the Power Up parameter press the Control Setup key and press Enter until the following display appears.

```
Select for Loop 1 ▲▼  
Power Up Disable
```

Use the ▲ or ▼ key to toggle between Power Up Enable and Disable. Press the **Enter** key.

**Control Setup (Continued)**

The Model 325 will display the heater output as either percent of full scale current or percent of full-scale power for the heater range selected. This parameter affects the heater output display and the scale of the Manual Heater Power (MHP) output parameter for Loop 1. The MHP Output scale is always the same as the control output display. To change control output units press the **Control Setup** key and press **Enter** until the following display appears.

```
Select for Loop 1 ▲▼
Heater Out Power
```

Use the **▲** or **▼** key to toggle between Heater Out Power and Current. Press the **Enter** key.

**4.8 MANUAL TUNING (Closed-Loop PID Control)**

In manual PID mode, the controller will accept user-entered Proportional, Integral, and Derivative parameters to provide three-term PID control. Manual heater power output can be set manually in open loop and closed loop control modes. For details on PID tuning refer to Section 2.7.

To place the controller in Manual PID tuning mode, press the **AutoTune** key, and press the **▲** or **▼** key until you see the following display.

```
Select for Loop 1 ▲▼
Tune Mode Manual PID
```

Press the **Enter** key. The controller is now in Manual PID mode.

**4.8.1 Manually Setting Proportional (P)**

The proportional parameter (also called gain) is the P part of the PID control equation. It has a range of 0 to 1000 with a resolution of 0.1. Enter a value greater than zero for P when using closed loop control.

To set Proportional, press the **P** key. You will see the following display.

```
Enter for Loop 1
Prop (P)      50.0
```

The Proportional (gain) limit is entered using the numeric keypad, which includes the numbers 0–9, +/-, and decimal point. Proportional has a range of 0 to 1000 with a default of 50. Press the **Enter** key to save changes and return to the normal display.

#### 4.8.2 Manually Setting Integral (I)

The integral parameter (also called reset) is the I part of the PID control equation. It has a range of 0 to 1000 with a resolution of 0.1. Setting I to zero turns the reset function off. The I setting is related to seconds by:

For example, a reset number setting of 20 corresponds to a time constant of 50 seconds. A system will normally take several time constants to settle into the setpoint. The 50-second time constant, if correct for the system being controlled, would result in a system that stabilizes at a new setpoint in between 5 and 10 minutes.

To set Integral, press the **I** key. You will see the following display.

```
Enter for Loop 1
Integ (I)      20.0
```

The Integral (reset) is entered using the numeric keypad, which includes the numbers 0–9, +/-, and decimal point. Integral has a range of 0 to 1000 with a default of 20. Press the **Enter** key to save changes and return to the normal display.

#### 4.8.3 Manually Setting Derivative (D)

The derivative parameter (sometimes called rate) is the D part of the PID control equation. The rate time constant should normally be somewhere between 1/4 and 1/8 the integral time in seconds, if used at all. As a convenience to the operator, the Model 325 Derivative time constant is expressed in percent of 1/4 the integral time. The range is between 0 and 200%. Start with settings of 0%, 50%, or 100%, and determine which setting gives you the type of control you desire. Do not be surprised if the setting you prefer is 0. Note that by using a percent of integral time, derivative scales automatically with changes in the integral value and does not have to be revisited frequently.

To set Derivative, press the **D** key. You will see the following display.

```
Enter for Loop 1
Deriv (D)      0.0
```

The Derivative (rate) is entered using the numeric keypad, which includes the numbers 0–9, +/-, and decimal point. Derivative has a range of 0 to 200 percent with a default of 0. Press the **Enter** key to save changes and return to the normal display.

#### 4.8.4 Setting Manual Heater Power (MHP) Output

Manual Heater Power (MHP) output is a manual setting of control output. It can function in two different ways depending on control mode. In open loop control mode, the MHP output is the only output to the load. The user can directly set control output from the front panel or over computer interface. In closed loop control mode, the MHP output is added directly to the output of the PID control equation. In effect, the control equation operates about the MHP output setting.

Manual heater power output setting is in percent of full scale. Percent of full scale is defined as percent of full-scale current or power on the selected heater range. Manual heater power output setting range is 0% to 100% with a resolution of 0.001%.

To enter a MHP Output setting, press the **Manual Heater** key. The following display appears.

```

Enter for Loop 1
Manual Out      0.00%
  
```

The MHP Output setting is entered using the numeric keypad, which includes the numbers 0–9, +/-, and decimal point. Press the **Enter** key, then the **Escape** key to return to the normal display.

#### 4.9 AUTOTUNE (Closed-Loop PID Control)

The Model 325 automates the tuning process of typical cryogenic systems with the AutoTune feature. For additional information about the algorithm refer to Section 2.8.

Before initiating AutoTune the cooling system must be set up properly with control sensor and heater making it capable of closed-loop control. AutoTune works only with one control loop at a time and does not set the manual heater power output or heater range. The control sensor must have a valid temperature response curve assigned to it. An appropriate heater range must also be determined as described in Section 2.7.1. Choosing good initial control parameters by experimenting with Manual PID tuning can speed up the AutoTune process. If no initial parameters are known start with the default values of P = 50 and I = 20. It is better to set an initial P value that causes the system to be more active than desired. Starting with a low P value can increase the time and number of attempts required to tune.

There are three AutoTune modes available. They result in slightly different system characteristics. Auto PI is recommended for most applications.

**Auto P** – Sets only the P parameter value. I and D are set to 0 no matter what the initial values are. This mode is recommended for systems that have very long lag times or nonlinearity that prevents stable PI control. Expect some overshoot or undershoot of the setpoint and stable temperature control below the setpoint value.

**Auto PI** – Sets values for both P and I parameters. D is set to zero. This mode is recommended for stable control at a constant temperature. It may take slightly longer to stabilize after setpoint change than Auto PID. Expect some overshoot or undershoot of the setpoint and stable temperature control at the setpoint value.

**Auto PID** – Sets values for P, I and D parameters. D is always set to 100%. This mode is recommended when setpoint changes are frequent but temperature is allowed to stabilize between changes. Stability at setpoint may be worse than Auto PI in noisy systems. Expect slightly less overshoot or undershoot than the other modes and control at the setpoint value.

**AutoTune (Continued)**

Once AutoTune mode is selected, no activity takes place until the setpoint is changed at least 0.5 K. At that time, the control channel annunciator blinks to indicate the instrument is gathering data. This process takes from 1 to 17 minutes depending on the system reaction time. The control channel annunciator stops blinking when calculations are complete and new parameter values have been stored. The annunciator will also stop blinking if the algorithm is unable to complete. Possible reasons include: setpoint change too small, manual control parameter changed during tuning, heater not turned on, or control sensor curve not selected.

If the controller is not tuned satisfactorily on the first attempt, make several small (2 degree) setpoint changes to see if better parameter values are calculated.

To select an AutoTune mode press the **AutoTune** key, and press the **▲**, **▼**, or **AutoTune** key to cycle the display to AutoTune PID. You will see the following display.

```
Select for Loop 1 ▲▼
Tune Mode  Auto PID
```

Use the **▲** or **▼** key to cycle between Auto PID, Auto PI, and Auto P. Press the **Enter** key. The controller is now in AutoTuning mode.

**4.10 ZONE SETTINGS (Closed-Loop Control Mode)**

The Model 325 allows the user to establish up to 10 custom contiguous temperature zones where the controller will automatically use pre-programmed PID values and heater ranges. Zone control can be active for both control loops at the same time. The user should configure the zones using 01 as the lowest to 10 as the highest zone. Zone boundaries are always specified in kelvin (K). The bottom of the first zone is always 0 K, therefore, only the upper limit is required for all subsequent zones. Make a copy of Figure 4-4 to plan your zones.

Once all zone parameters have been programmed, the controller must be placed in zone tuning mode. To do this, press the **AutoTune** key. Use the **▲** or **▼** key to select Zone. Then press **Enter** to accept the new tuning mode. Once zone is turned on, the instrument will update the control settings each time the setpoint is changed to a new zone. If the settings are changed manually, the controller will use the new setting while it is in the same zone and update to the zone table settings when the setpoint is changed to a value outside that zone.

To enter parameter values into the zone table, press the **Zone Settings** key. You will see the following display.

```
Select for LOOP 1 ▲▼
Zone  01
```

Use the **▲** or **▼** key to cycle through the ten zones. Once the desired zone is displayed, press the **Enter** key. You will see the next display.

```
Enter for Zone 01
SP Limit    0.0000k
```

The upper setpoint limit is entered using the numeric keypad, which includes the numbers 0–9, +/–, and decimal point. During numeric entry, you can press the **Escape** key one time to clear the entry, and a second time to exit to the normal display.

**NOTE:** The default setting for all the zone setpoints is zero (0). The Model 325 will not search for additional zones once it encounters a setpoint of zero.

Press the **Enter** key to accept the new upper limit. You will see the next display.

```

Enter for Zone 01
Prof (P)      50.0
    
```

The Proportional (P) value is entered using the numeric keypad, which includes the numbers 0–9, +/-, and decimal point. Proportional has a range of 0 to 1000 with a default of 50. Press the **Enter** key to accept the new setting. You will see the next display.

```

Enter for Zone 01
Integ (I)     20.0
    
```

The Integral (I) value is entered using the numeric keypad, which includes the numbers 0–9, +/-, and decimal point. Integral has a range of 0 to 1000 with a default of 20. Press the **Enter** key to accept the new setting. You will see the next display.

```

Enter for Zone 01
Deriv (D)     0.0
    
```

The Derivative (D) value is entered using the numeric keypad, which includes the numbers 0–9, +/-, and decimal point. Derivative has a range of 0 to 200 percent with a default of 0. Press the **Enter** key to accept the new setting. You will see the next display.

```

Enter for Zone 01
Manual Out    0.00%
    
```

The MHP Output setting is entered using the numeric keypad, which includes the numbers 0–9, +/-, and decimal point. Manual heater has a range of 0 to 100 percent with a default of 0. Press the **Enter** key to accept the new heater setting. Assuming the zone is controlling using Loop 1, you will see the next display.

```

Select for Zone01 ▲▼
Heater Range  Off
    
```

Use the ▲ or ▼ key to select the Heater Range: High, Low, or Off. Press the **Enter** key to accept the new heater range and return to the normal display. (If you are controlling using Loop 2, the last heater range setting is omitted.) This completes the setting of Zone 01. Repeat the process for the subsequent zones.



## Zone Setting WorkSheet

Zone 10	↑	Proportional (0.1-1000)	Integral (0.1-1000)	Derivative (0-200)	MHP Output (0-100%)	Setpoint: _____ K
		_____	_____	_____	_____	Heater Range
						Off Low High
Zone 09	↑	Proportional (0.1-1000)	Integral (0.1-1000)	Derivative (0-200)	MHP Output (0-100%)	Setpoint: _____ K
		_____	_____	_____	_____	Heater Range
						Off Low High
Zone 08	↑	Proportional (0.1-1000)	Integral (0.1-1000)	Derivative (0-200)	MHP Output (0-100%)	Setpoint: _____ K
		_____	_____	_____	_____	Heater Range
						Off Low High
Zone 07	↑	Proportional (0.1-1000)	Integral (0.1-1000)	Derivative (0-200)	MHP Output (0-100%)	Setpoint: _____ K
		_____	_____	_____	_____	Heater Range
						Off Low High
Zone 06	↑	Proportional (0.1-1000)	Integral (0.1-1000)	Derivative (0-200)	MHP Output (0-100%)	Setpoint: _____ K
		_____	_____	_____	_____	Heater Range
						Off Low High
Zone 05	↑	Proportional (0.1-1000)	Integral (0.1-1000)	Derivative (0-200)	MHP Output (0-100%)	Setpoint: _____ K
		_____	_____	_____	_____	Heater Range
						Off Low High
Zone 04	↑	Proportional (0.1-1000)	Integral (0.1-1000)	Derivative (0-200)	MHP Output (0-100%)	Setpoint: _____ K
		_____	_____	_____	_____	Heater Range
						Off Low High
Zone 03	↑	Proportional (0.1-1000)	Integral (0.1-1000)	Derivative (0-200)	MHP Output (0-100%)	Setpoint: _____ K
		_____	_____	_____	_____	Heater Range
						Off Low High
Zone 02	↑	Proportional (0.1-1000)	Integral (0.1-1000)	Derivative (0-200)	MHP Output (0-100%)	Setpoint: _____ K
		_____	_____	_____	_____	Heater Range
						Off Low High
Zone 01	↑	Proportional (0.1-1000)	Integral (0.1-1000)	Derivative (0-200)	MHP Output (0-100%)	Setpoint: _____ K
		_____	_____	_____	_____	Heater Range
						Off Low High
0 K	↑	_____	_____	_____	_____	0 K

C-325-4-4.bmp

Figure 4-4. Record of Zone Settings

#### 4.11 SETPOINT

The control setpoint is the desired load temperature expressed in temperature or sensor units. Use sensor units if no temperature response curve is selected for the sensor input used as the control channel.

The control setpoint has its own units parameter. Set with the **Control Setup** key in Section 4.7. Control channel readings can display in any units. Display units need not match setpoint units.

**NOTE:** If a curve is not assigned to the control input, control reverts to sensor units and the setpoint is set to the most current reading.

When changing setpoint units while the control loop is active, the Model 325 converts the control setpoint to the new control units for minimal disruption in control output.

Setpoint resolution depends on sensor type and setpoint units. With setpoint expressed in temperature, setpoint resolution is 0.001 degree for setpoints below 100, and 0.01 for setpoints between 100 and 1000. In sensor units, the setpoint resolution matches the display resolution for the sensor input type given in the specifications (Section 1.2).

The instrument allows a large setpoint range to accommodate a variety of sensors and units. With setpoint expressed in sensor units, setpoint range is unlimited. The user must determine suitability of a setpoint value. In temperature units, a safety feature limits the setpoint value to help prevent load damage. The setpoint limit in the temperature response curve sets maximum safe temperature in kelvin for the sensor package. It can be verified by using the Curve Entry key. The setpoint is limited to a value less than or equal to the limit. If the setpoint value changes from the number entered when Enter is pressed, it is likely the setpoint exceeds the above limit or is inappropriate for the sensor type.

Once control setup parameters are configured (Section 4.7) and the active control loop is selected (Section 4.6.1), the desired temperature setpoint is entered by pressing the **Setpoint** key.

```
Enter for Loop 1
Setpoint  77.350k
```

The setpoint is entered using the numeric keypad, which includes the numbers 0–9, +/-, and decimal point. Press the **Enter** key to accept the new setpoint or press the **Escape** key to cancel.

If the display format is configured to show the setpoint (Section 4.3), you will see something resembling the following for a normal display.

```
A 77.236k  B 295.22k
S 77.350k  50% Low
```

## 4.12 RAMP

The Model 325 generates a smooth setpoint ramp when the setpoint units are expressed in temperature. The user can set a ramp rate in degrees per minute with a range of 0 to 100 and a resolution of 0.1. Once the ramp feature is turned on, its action is initiated by a setpoint change. When a new setpoint is entered, the instrument changes the setpoint temperature from the old value to the new value at the ramp rate. A positive ramp rate is always entered; it is used by the instrument for up and down ramps in temperature.

The ramping feature is useful by itself but it is even more powerful when used with other features. Setpoint ramps are often used with zone control mode. As temperature is ramped through different temperature zones, control parameters are automatically selected for best control. Ramps can be initiated and status read back using a computer interface. During computer-controlled experiments, the instrument generates the setpoint ramp while the computer is busy taking necessary data. AutoTune does not function during a setpoint ramp. The ramp rate disguises the reaction of the cooling system and no valid tuning data can be taken.

**NOTE:** When an incomplete ramp is shut off, the setpoint will remain on the most current setting, i.e., the reading will not jump to the end of the ramp.

**NOTE:** If the input type or input curve is changed while a ramp is in progress, both ramping and the heater are turned off.

**NOTE:** If Ramp is on and the setpoint is set to sensor units, the ramping function will remain on but when another setpoint is entered, the setpoint goes directly to the new setpoint value.

To enable setpoint ramping, press the **Control Setup** key, then press the **Enter** key until you see the following display.

```
Select for Loop 1 ▲▼
Setpoint Ramp On
```

Use the **▲** or **▼** key to select Setpoint Ramp On. Press the **Enter** key. You will see the following.

```
Enter for Loop 1
Ramp Rate 0.0 K/m
```

The ramp rate is entered using the numeric keypad, which includes the numbers 0–9 and decimal point. The user can set a ramp rate in degrees per minute with a range of 0 to 100 and a resolution of 0.1. Ramp rate will be in the same units specified for the setpoint. Press the **Enter** key. Any subsequent change in setpoint will ramp at the specified rate.

If you wish to pause a ramp, press the **Setpoint** key then immediately press the **Enter** key. This stops the ramp at the current setpoint but leaves the ramping function activated. Then to continue the ramp, enter a new setpoint.

To turn the ramping feature off, press the Control Setup key, then press the Enter key until you see the following screen.

```
Select for Loop 1 ▲▼
Setpoint Ramp Off
```

Use the **▲** or **▼** key to select Setpoint Ramp Off. Press the **Enter** key then the **Escape** key. The Ramp LED will turn off.

### 4.13 HEATER RANGE AND HEATER OFF

The heater output for Loop 1 is a well-regulated variable DC current source, while the heater output for Loop 2 is a variable DC voltage source. Both heater outputs are optically isolated from the sensor input circuits to reduce interference and ground loops. The heater output for the main control loop (Loop 1) can provide up to 25 W of continuous power to a resistive heater load and includes a low range for systems with less cooling power, while the Loop 2 heater output can provide up to 2 W of continuous power. Both Loop 1 and Loop 2 Heater outputs are short-circuit protected to prevent instrument damage if the heater load is accidentally shorted.

**NOTE:** During normal operation, if the input type or input curve is changed for the control input, the heater will automatically shut off.

Specifications of the heater outputs are provided in Section 1.2 – Specifications. Heater theory of operation is provided in Section 2.4 – Heater Selection and Installation. Various Heater installation considerations are provided in Section 3.6 – Heater Output Setup.

Once control setup parameters are configured (Section 4.7), and the active control loop is selected (Section 4.6.1), the desired heater range is selected by pressing the **Heater Range** key.

```
Select for Loop 1 ▲▼
Heater Range Off
```

Use the ▲ or ▼ key to cycle through Loop 1 Heater settings: Off, Low, and High. Once the desired heater setting is displayed, press the **Enter** key. You will return to the normal display.

Use the ▲ or ▼ key to toggle between Loop 2 Heater settings: Off and On. Once the desired heater setting is displayed, press the **Enter** key. You will return to the normal display.

To immediately turn the heater off, press the **Heater Off** key. If the Heater Range is not being displayed on the front panel, the user should immediately press the **Heater Range** key to verify that the proper loop is displayed and the heater shows Off.

### 4.14 HEATER RESISTANCE SETTING

The Model 325 Loop 1 and Loop 2 heater outputs are designed to accommodate two common heater resistance values: 25  $\Omega$  and 50  $\Omega$ . In order to achieve full output power, and stable temperature control over the full output range (0 – 100%) the heater resistance setting must be set properly for both control loops. For Loop 1, the heater resistance setting controls the heater output compliance voltage (50  $\Omega$  setting = 36 V nominal, 25  $\Omega$  setting = 25 V nominal). Loop 1 was designed to provide 0 – 1 A of output current for heaters up to 20% lower than the nominal heater resistance when the proper heater resistance setting is used. For Loop 2, the heater resistance setting controls the heater output full-scale voltage (50  $\Omega$  setting = 10 V, 25  $\Omega$  setting = 5 V). If the heater resistance setting is not set properly limiting could occur, which could result in temperature control instability. An exception occurs when using a heater greater than the heater resistance setting on Loop 2. In this situation the maximum heater power is lowered as the heater resistance increases, but control over the full output range will not be limited.

To set the heater resistance for the currently displayed loop, press the **Control Setup** key, then press the **Enter** key until you see the following display.

```
Select for Loop 1 ▲▼
Heater Load: 25 $\Omega$ 
```

Use the ▲ or ▼ key to select 25  $\Omega$  or 50  $\Omega$ . Press the **Enter** key to save changes and return to the normal display.

#### 4.15 LOCKING AND UNLOCKING THE KEYPAD

The keypad lock feature prevents accidental changes to parameter values. When the keypad is locked, some parameter values may be viewed, but most cannot be changed from the front panel. Heater Off is the only keypad function that remains active when the keypad is locked.

A 3-digit keypad lock code locks and unlocks the keypad. The factory default code is **123**. The code can be changed only through the computer interface. If instrument parameters are reset to default values, the lock code resets also. The instrument cannot reset from the front panel with the keypad locked.

To lock the keypad, press and hold the **Enter** key for 10 seconds to display the screen shown as follows.



```
Enter Code To  
Lock Keypad
```

Use the numeric keypad to enter the 3-digit lock code. The keypad locks and the normal display appears. Changes attempted to any parameters result in a brief display of the \*LOCKED\* message.

To unlock the keypad, press and hold the **Enter** key for 10 seconds to display the screen shown as follows.



```
Enter Code To  
Unlock Keypad
```

Use the numeric keypad to enter the 3-digit lock code. The keypad unlocks and the normal display again appears. All Model 325 parameters are now accessible.

#### 4.16 REMOTE/LOCAL

“Local” refers to operating the Model 325 from the front panel. “Remote” refers to operating the controller via the IEEE-488 Interface. The keypad is disabled during remote operation. The mode of operation can be changed by pressing the **Remote/Local** key. When in remote mode an “R” will be displayed in the rightmost character on the top line of the LCD display. When in local mode, the character will be blank.

#### 4.17 INTERFACE

The **Interface** key serves two functions: set the serial interface baud rate, and set the IEEE-488 interface address and terminators.

To set the serial interface baud rate, press the **Interface** key.



```
Select With ▲▼  
Baud 9600
```

Use the **▲** or **▼** key to cycle through the choices of 9600, 19200, 38400, 57600 baud. The default baud rate is 9600. Press the **Enter** key to accept the changes or the **Escape** key to keep the existing setting and return to the normal display.

**Interface (Continued)**

To set the IEEE-488 interface address and terminators, press the **Interface** key, then press the **Enter** key until you see the following screen.

```
Select With ▲▼  
IEEE Address 12
```

Use the ▲ or ▼ key to increment or decrement the IEEE address to the desired number. The default address is 12. Press the **Enter** key to accept the changes or the **Escape** key to keep the existing setting and return to the normal display. Press the **Enter** key again to see the following screen.

```
Select With ▲▼  
IEEE Term Cr Lf
```

Use the ▲ or ▼ key to cycle through the following terminator choices: Cr Lf, Lf Cr, Lf, or EOI, where Cr = Carriage Return, Lf = Line Feed, and EOI = End Or Identify. The default terminator is Cr Lf. Press the **Enter** key to accept the changes and continue to the next screen, or the **Escape** key to keep the existing setting and return to the normal display.

**4.18 DEFAULT VALUES**

It is sometimes necessary to reset instrument parameter values or clear out the contents of curve memory. Both are all stored in nonvolatile memory called NOVRAM but they can be cleared individually. Instrument calibration is not affected except for Room Temperature Calibration, which should be redone after parameters are set to default values or any time the thermocouple curve is changed.

To reset the Model 325 parameters to factory default values, press and hold the **Escape** key until the screen shown below appears.

```
Main Version: 1.0  
Default Values Yes
```

Use the ▲ or ▼ key to select Yes or No to reset the NOVRAM. Select Yes to reset all Model 325 parameters to the defaults listed in Table 4-5. Press the **Enter** key. The second screen appears as follows.

```
Input Version 1.0  
Clear Curves No
```

Use the ▲ or ▼ key to select Yes or No to clear the user curves (in locations 21 – 35) stored in the Model 325. Standard curves (in locations 1 – 20) are unaffected. Press the **Enter** key. The instrument performs the operation then returns to the normal display.

**Table 4-4. Default Values**

<p><b>Control Setup</b>            Control Input ..... Input A            SP Units..... Temp K            Control Mode ..... Closed            Power Up..... Disable            Setpoint Ramp ..... Off            Heater Output Display..... Current</p> <p><b>Display Format</b>            Display Location 1 ..... Input A / Temp K            Display Location 2 ..... Input B / Temp K            Display Location 3 ..... Setpoint            Display Location 4 ..... Heater Output</p> <p><b>Heater</b>            Heater Range ..... Off</p> <p><b>Input Setup – Diode/Resistor Configuration</b>            Input Type ..... Silicon Diode            Curve ..... DT-470</p> <p><b>Input Setup – Thermocouple Configuration</b>            Input Type ..... Thermocouple/25mV            Curve ..... Type K            Room Comp ..... On            Room Cal ..... Cleared</p> <p><b>Interface</b>            Baud ..... 9600            IEEE Address ..... 12            IEEE Terminators..... CR/LF</p>	<p><b>Keypad Locking</b>            Mode..... Unlocked            Lock Code ..... 123</p> <p><b>Loop</b>            Selected Loop ..... Loop 1</p> <p><b>PID/Manual Heater Power (MHP) Output</b>            Proportional (P) ..... 50.0            Integral (I)..... 20.0            Derivative (D)..... 0.0            MHP Output ..... 0.000%</p> <p><b>Remote/Local</b>            Remote/Local ..... Local</p> <p><b>Setpoint</b>            Setpoint Value ..... 0.000K</p> <p><b>Tuning</b>            Tuning Mode ..... Manual PID</p> <p><b>Zone Settings – All Zones</b>            Setpoint Limit ..... 0.000K            Proportional (P) ..... 50.0            Integral (I)..... 20.0            Derivative (D)..... 0.00            Manual Output..... 0.000%</p>
---	---

This Page Intentionally Left Blank



# CHAPTER 5

## ADVANCED OPERATION

### 5.0 GENERAL

This chapter provides information on the advanced operation of the Model 325 temperature controller.

#### 5.1 CURVE NUMBERS AND STORAGE

The Model 325 has 20 standard curve locations, numbered 1 through 20. At present, not all locations are occupied by curves; the others are reserved for future updates. If a standard curve location is in use, the curve can be viewed using the edit operation. Standard curves cannot be changed by the user, and reserved locations are not available for user curves.

The Model 325 has 15 user curve locations, numbered 21 through 35. Each location can hold from 2 to 200 data pairs (breakpoints), including a value in sensor units and a corresponding value in kelvin. Using fewer than 200 breakpoints will not increase the number of available curve locations. SoftCal-generated curves are stored in user curve locations.

##### 5.1.1 Curve Header Parameters

Each curve has parameters that are used for identification and to allow the instrument to use the curve effectively. The parameters must be set correctly before a curve can be used for temperature conversion or temperature control.

**Curve Number:** 1–35.

**Name:** Defaults to the name **User Curve** for front panel entry. When entering a user curve over the computer interface, a curve name of up to 15 characters can be entered.

**Serial Number:** Up to a 10-character sensor serial number. Both numbers and letters can be entered over computer interface; only numbers can be entered from the front panel.

**Format:** The format parameter tells the instrument what breakpoint data format to expect. Different sensor types require different formats. Formats for Lake Shore sensors are:

**V/K:** Volts vs. kelvin for diode sensors.

**$\Omega$ /K:** Resistance vs. kelvin for platinum RTD sensors.

**Log  $\Omega$ /K:** Log resistance vs. kelvin for NTC resistive sensors.

**mV/K:** Millivolts vs. kelvin for thermocouple sensors.

**Limit:** Enter a temperature limit in kelvin for the curve. Default is 375 K. Enter a setting of 9999 K if no limit is needed.

**Temperature Coefficient:** The unit derives the temperature coefficient from the first two breakpoints. The user does not enter this setting. If it is not correct, check for proper entry of those points. A positive coefficient (**P**) indicates that the sensor signal increases with increasing temperature. A negative coefficient (**N**) indicates that the sensor signal decreases with increasing temperature.

##### 5.1.2 Curve Breakpoints

Temperature response data of a calibrated sensor must be reduced to a table of breakpoints before entering it into the instrument. Each breakpoint consists of one value in sensor units and one temperature value in kelvin. Linear interpolation is used by the instrument to calculate temperature between breakpoints. From 2 to 200 breakpoints can be entered as a curve. The instrument will show an error message on the display if the sensor input is outside the range of the breakpoints. No special endpoints are required. Sensor units are defined by the format setting in Table 5-2.

Breakpoint setting resolution is six digits in temperature. Most temperature values are entered with 0.001 resolution. Temperature values of 1000 K and greater can be entered to 0.01 resolution. Temperature values below 10 K can be entered with 0.0001 resolution. Temperature range for curve entry is 1500 K.

**Table 5-1. Curve Header Parameters**

<b>Name:</b>	The curve name cannot be changed from the front panel. Curve names can only be entered over the computer interface (up to 15 characters). The default curve name is User xx, where xx is the curve number.			
<b>Serial Num:</b>	Identify specific sensors with serial numbers of up to 10 characters. The serial number field accepts both numbers and letters, but the instrument front panel enters only numbers. To enter both numbers and letters, enter curves over computer interface. The default is blank.			
<b>Curve Format:</b>	The instrument must know the data format of the curve breakpoints. Different sensor types use different data formats. The sensor inputs require one of the formats below. The range and resolution specified are not always available at the same time. Practical range and resolution depend on the sensor type.			
	<i>Format</i>	<i>Description</i>	<i>Sensor Units Full Scale Range</i>	<i>Sensor Units Maximum Resolution</i>
	V/K	Volts vs. kelvin	10 (V)	0.00001 (V)
	$\Omega$ /K	Resistance vs. kelvin	10 K ( $\Omega$ )	0.001 ( $\Omega$ )
	log $\Omega$ /K	Log resistance vs. kelvin	4 (log $\Omega$ )	0.00001 (log $\Omega$ )
	mV/K	Millivolts vs. kelvin	$\pm$ 100 (mV)	0.0001 (mV)
<b>SP Limit</b>	A setpoint temperature limit can be included with every curve. When controlling in temperature, the setpoint cannot exceed the limit entered with the curve for the control sensor. The default is 375 K. Set to 9999 K if no limit is required.			
<b>Coeff:</b>	The instrument derives the temperature coefficient from the first two breakpoints. If it is set improperly, check the first two breakpoints. A positive coefficient indicates the sensor signal increases with increasing temperature. A negative coefficient indicates the sensor signal decreases with increasing temperature.			

**Table 5-2. Recommended Curve Parameters**

Type	Typical Lake Shore Model	Units	Format	Limit (K)	Coefficient	Recommended Sensor Resolution
Silicon Diode	DT-470	V	V/K	475	Negative	0.00001 (V)
GaAlAs Diode	TG-120	V	V/K	325	Negative	0.00001 (V)
Platinum 100	PT-100	$\Omega$	$\Omega$ /K	800	Positive	0.001 ( $\Omega$ )
Platinum 1000	PT-100	$\Omega$	$\Omega$ /K	800	Positive	0.01 ( $\Omega$ )
Rhodium-Iron	RF-100	$\Omega$	$\Omega$ /K	325	Positive	0.001 ( $\Omega$ )
Carbon-Glass	CGR-1-1000	$\Omega$	log $\Omega$ /K	325	Negative	0.00001 (log $\Omega$ )
Cernox™	CX-1030	$\Omega$	log $\Omega$ /K	325	Negative	0.00001 (log $\Omega$ )
Germanium	GR-200A-100	$\Omega$	log $\Omega$ /K	325	Negative	0.00001 (log $\Omega$ )
Rox™	RX-102A	$\Omega$	log $\Omega$ /K	40	Negative	0.00001 (log $\Omega$ )
Type K	9006-005	mV	mV/K	1500	Positive	0.0001 (mV)
Type E	9006-003	mV	mV/K	930	Positive	0.0001 (mV)
Type T	9006-007	mV	mV/K	673	Positive	0.0001 (mV)
Au-Fe 0.03%	<i>No Longer Sold</i>	mV	mV/K	500	Positive	0.0001 (mV)
Au-Fe 0.07%	9006-001	mV	mV/K	610	Positive	0.0001 (mV)

**Curve Breakpoints (Continued)**

Setting resolution is also six digits in sensor units. The curve format parameter defines the range and resolution in sensor units as shown in Table 5-2. The sensor type determines the practical setting resolution. Table 5-2 lists recommended sensor units resolutions. For most sensors, additional resolution is ignored.

The breakpoints should be entered with the sensor units value increasing as point number increases. There should not be any breakpoint locations left blank in the middle of a curve. The search routine in the Model 325 interprets a blank breakpoint as the end of the curve.

**5.2 FRONT PANEL CURVE ENTRY OPERATIONS**

There are three operations associated with front panel curve entry: Edit curve, Copy curve, Erase curve; as detailed below.

<b>Edit Curve</b>	Edit allows the user to see any curve and enter or edit a curve at any user curve location. Standard curves cannot be changed.	Refer to Section 5.2.1
<b>Erase Curve</b>	Erase allows the user to delete a curve from any user curve location. Standard curves cannot be erased.	Refer to Section 5.2.2
<b>Copy Curve</b>	Copy allows the user to copy a curve from any location to any user curve location. Curves cannot be copied into standard curve locations.	Refer to Section 5.2.3
<b>SoftCal</b>	Allows creation of a new temperature curve from a standard curve and known data points entered by the user.	Refer to Section 5.3

To begin a curve operation, press the **Curve Entry** key and the above selections appear. Press the **Next Setting** key until the desired operation is highlighted and press the **Enter** key. A curve screen appears with the curve number highlighted. Change to the desired curve number with the up or down arrow key, then press the **Enter** key to begin the desired curve operation.

**5.2.1 Edit Curve**

The Edit Curve operation is used to enter a new curve or edit an existing user curve. Only user curves (21 to 35) can be changed. Standard curves can only be viewed with the edit operation. Entering the identification parameters associated with the curve is as important as entering the breakpoints. Curve header parameters are listed in Table 5-1. Typical parameters for common sensors are listed in Table 5-2. Read this section completely and gather all necessary data before beginning the process.

**NOTE:** If the curve you wish to enter has similar parameters to an existing curve, first copy the similar curve (as described in Section 5.2.3) to a new location, then edit the curve to the desired parameters.

To enter a new user curve or edit an existing user curve, press the **Curve Entry** key. Press the **▲** or **▼** key until you see the following display.

```
Select With ▲▼
Edit Curve
```

Press the **Enter** key. Press the **Escape** key any time during this routine to return to the normal display.

```
Select for Edit   ▲▼
Curve 21 User
```

Use the **▲** or **▼** key to cycle through the various curves. Curve numbers 21 through 35 are used to copy or create new curves. You can also view (but not modify) the standard curve numbers 01 through 20 from here. For this example, we will enter a new curve in location 21. Press the **Enter** key.

**Edit Curve (Continued)**

```
Enter for Curve 21
Serial # 0123456789
```

Use the numerical keypad to enter the applicable sensor serial number; to a maximum of 10 digits. For this example, we will enter 0123456789. Press the **Enter** key.

```
Select for Curv21 ▲▼
Curve Format V/K
```

Use the **▲** or **▼** key to cycle through the curve formats: V/K,  $\Omega$ /K, log  $\Omega$ /K, mV/K, where V/K = volts per kelvin,  $\Omega$ /K = ohms per kelvin, log  $\Omega$ /K = logarithm of the resistance per kelvin, and mV/K = millivolts per kelvin. For this example, we will select V/K. Press the **Enter** key.

```
Enter for Curve 21
SP Limit 475.00k
```

Use the numerical keypad to enter a setpoint limit (in kelvin) appropriate for the sensor being used. For this example, we will enter 475.00K. Press the **Enter** key.

```
View for Curve 21
Temp Coeff Positive
```

The temperature coefficient (positive or negative) of the curve is displayed. The coefficient is calculated from the first two points of the curve and cannot be changed. Press the **Enter** key.

Now that the curve identification parameters are entered, it is time to enter curve breakpoints.

```
User Curve 21
1: 0.00000v 00.0000k
```

The cursor initially blinks on the curve breakpoint number. When the cursor is in this position, use the **▲** or **▼** key to scroll through the breakpoints in the curve. Press the **Enter** key to modify the current breakpoint. Use the numerical keypad to enter the applicable sensor value. For this example, we will enter 0.09062V, then press the **Enter** key. The cursor will jump to the temperature reading. Again use numerical keypad to enter the applicable temperature in kelvin. For this example, we will enter 475.0K. Press the **Enter** key.

```
1: 0.09062v 475.000k
2: 0.00000v 00.0000k
```

Use the numerical keypad to enter the remaining voltage and temperature points. After entering the final point in the curve, press the **Enter** key, then the **Escape** key. You will return to the normal display.

To add a new breakpoint to an existing curve, go to the end of the curve data and enter the new sensor reading and temperature. Press the **Enter** key, then the **Escape** key. The new point is automatically put into its proper place in breakpoint sequence.

### **Edit Curve (Continued)**

**NOTE:** Typing over an existing reading or temperature will replace that value when you press the **Enter** key.

To delete a breakpoint, go to point and enter zeros for both the sensor reading and temperature. Press the **Enter** key, then the **Escape** key.

When curve entry is complete, the user must assign the new curve to an input. The Model 325 does not automatically assign the new curve to either input.

#### **5.2.1.1 Thermocouple Curve Considerations**

The following are things to consider when generating thermocouple curves.

- Users may enter temperature response curves for all types of thermocouples. Enter curve data in mV/K format with thermocouple voltage in millivolts and temperature in kelvin.
- The curve must be normalized to 0 mV at 273.15 K (0 °C). Thermocouple voltages in millivolts are positive when temperature is above that point and negative when temperature is below that point.
- To convert curves published in Celsius to kelvin, add 273.15 to the temperature in Celsius.
- The temperature range for some thermocouple types may extend below 1 K or above 1000 K.
- The input voltage of the 325 is limited to  $\pm 50$  mV, so any part of the curve that extends beyond  $\pm 50$  mV is not usable by the instrument.
- A message of S-OVER or S-UNDER on the display indicates that the measured thermocouple input is over or under the  $\pm 50$  mV range.

#### **5.2.2 Erase Curve**

User curves that are no longer needed may be erased. Erase Curve sets all identification parameters to default and blanks all breakpoint values.

To erase an existing user curve, press the **Curve Entry** key. Press the **▲** or **▼** key until you see the following display.

```
Select With ▲▼  
Erase Curve
```

Press the **Enter** key. You can press the **Escape** key any time during this routine to return to the normal display.

```
Select for Erase ▲▼  
Curve 21 User
```

Use the **▲** or **▼** key to cycle through the various user curve numbers 21 through 35. You cannot erase the standard curve numbers 01 through 20. Once the user curve number is selected, press the **Enter** key. You will see the following message.

```
Press Esc. to cancel  
or Enter to erase 21
```

Press the **Escape** key to cancel or the **Enter** key to erase the selected user curve. You now return to the normal display.

### 5.2.3 Copy Curve

Temperature curves can be copied from one location inside the Model 325 to another. This is a good way to make small changes to an existing curve. Curve copy may also be necessary if the user needs the same curve with two different temperature limits or needs to extend the range of a standard curve. The curve that is copied from is always preserved.

**NOTE:** The copy routine allows you to overwrite an existing user curve. Please ensure the curve number you are writing to is correct before proceeding with curve copy.

To copy a curve, press the **Curve Entry** key. Press the **▲** or **▼** key until you see the following display.

```
Select With ▲▼
Copy Curve
```

Press the **Enter** key. You can press the **Escape** key any time during this routine to return to the normal display.

```
Select Copy from ▲▼
Curve 01 DT-470
```

Use the **▲** or **▼** key to select the curve number (01 through 35) to copy from. Once the curve number is selected, press the **Enter** key. You will see the following message.

```
Select Copy to ▲▼
Curve 21 User
```

Use the **▲** or **▼** key to select the curve number (21 through 35) to copy to. Press the **Enter** key to copy the curve. You now return to the normal display.

## 5.3 SOFTCAL™

The Model 325 allows the user to perform inexpensive sensor calibrations with a set of algorithms called SoftCal. The two SoftCal algorithms in the Model 325 work with DT-400 Series silicon diode sensors and platinum sensors. They create a new temperature response curve from the standard curve and known data points entered by the user. The new curve loads into one of the user curve locations (21 through 35) in the instrument. The following sections describe the data points needed from the user and the expected accuracy of the resulting curves.

Both DT-400 Series and platinum SoftCal algorithms require a standard curve that is already present in the Model 325. When the user enters the type of sensor being calibrated, the correct standard curve must be selected. When calibration is complete, the user must assign the new curve to an input. The Model 325 does not automatically assign the newly generated curve to either input.

Calibration data points must be entered into the Model 325. These calibration points are normally measured at easily obtained temperatures like the boiling point of cryogenics. Each algorithm operates with one, two, or three calibration points. The range of improved accuracy increases with more points.

There are two ways to get SoftCal calibration data points: ① The user can record the response of an unknown sensor at well controlled temperatures, or ② The user can purchase a SoftCal calibrated sensor from Lake Shore. There are advantages to both methods.

- ① **User:** When the user can provide stable calibration temperatures with the sensor installed, SoftCal calibration eliminates errors in the sensor measurement as well as the sensor. Thermal gradients, instrument accuracy, and other measurement errors can be significant to some users. Calibration can be no better than user-supplied data.
- ② **Purchased:** Lake Shore sensors with SoftCal calibration include a set of calibration points in the calibration report. The SoftCal calibration points are generated in a controlled calibration facility at Lake Shore for best accuracy. The calibration points can be entered into the Model 325 so it can generate a curve. If the CalCurve service is purchased with the calibrated sensor, the curve is also generated at the factory and can be entered like any other curve.

### 5.3.1 SoftCal™ with Silicon Diode Sensors

Lake Shore silicon diode sensors incorporate remarkably uniform sensing elements that exhibit precise, monotonic, and repeatable temperature response. For example, the Lake Shore DT-470 Series of silicon diode sensors has a repeatable temperature response from 2 K to 475 K. These sensors closely follow the Standard Curve 10 response and routinely interchange with one another. SoftCal is an inexpensive way to improve the accuracy of an already predictable sensor.

**NOTE:** Standard Curve 10 is the name of the temperature response curve, not its location inside the Model 325. Standard Curve 10 is stored in curve location number 1 in the Model 325.

A unique characteristic of DT-400 Series diodes is that their temperature responses pass through 28 K at almost exactly the same voltage. This improves SoftCal algorithm operation by providing an extra calibration data point. It also explains why SoftCal calibration specifications are divided into two temperature ranges, above and below 28 K. See Figure 5-1.

**Point 1:** Calibration data point at or near the boiling point of helium, 4.2 K. Temperatures outside 2 K to 10 K are not allowed. This data point improves between the calibration data point and 28 K. Points 2 and 3 improve temperatures above 28 K.

**Point 2:** Calibration data point at or near the boiling point of nitrogen (77.35 K). Temperatures outside 50 K to 100 K are not allowed. This data point improves accuracy between 28 K and 100 K. Points 2 and 3 together improve accuracy to room temperature and above.

**Point 3:** Calibration data point near room temperature (305 K). Temperatures outside the range of 200 K to 350 K are not allowed.

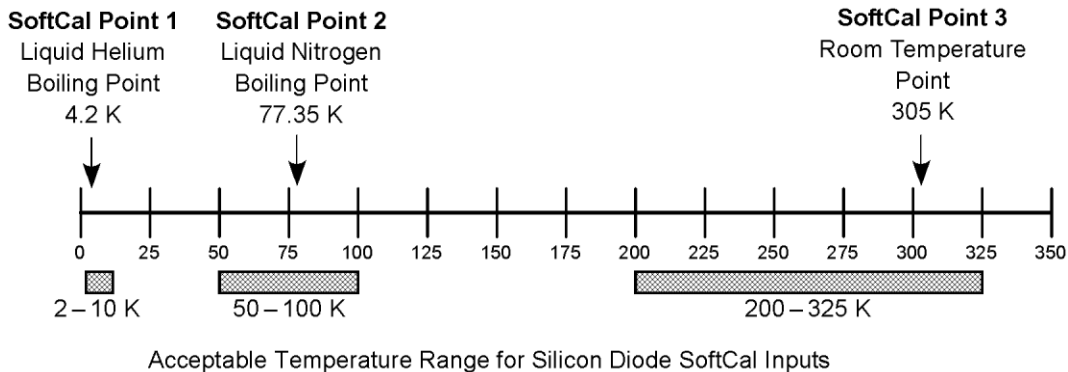


Figure 5-1. SoftCal Temperature Ranges for Silicon Diode Sensors

### 5.3.2 SoftCal™ Accuracy with Silicon Diode Sensors

A SoftCal calibration is only as good as the accuracy of the calibration points. The accuracies listed for SoftCal assume  $\pm 0.01$  K for 4.2 K (liquid helium),  $\pm 0.05$  K for 77.35 K (liquid nitrogen), and 305 K (room temperature) points. Users performing the SoftCal with Lake Shore instruments should note that the boiling point of liquid cryogen, though accurate, is affected by atmospheric pressure. Use calibrated standard sensors if possible.

One-point SoftCal calibrations for applications under 30 K are performed at liquid helium (4.2 K) temperature. Accuracy for the DT-470-SD-13 diode is  $\pm 0.5$  K from 2 K to  $<30$  K with no accuracy change above 30 K.

Two-point SoftCal calibrations for applications above 30 K are performed at liquid nitrogen (77.35 K) and room temperature (305 K). Accuracy for the DT-470-SD-13 diode sensor is as follows:

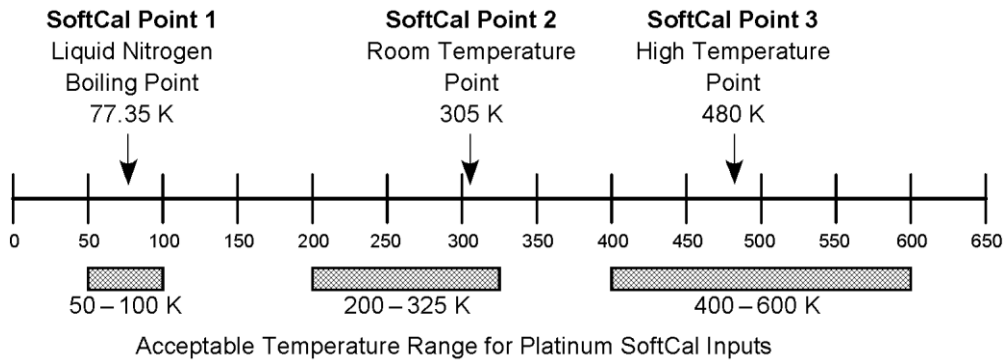
$\pm 1.0$ K	2 K to $<30$ K (no change below 30 K)	$\pm 0.25$ K	345 K to $<375$ K
$\pm 0.25$ K	30 K to $<60$ K	$\pm 1.0$ K	375 to 475 K
$\pm 0.15$ K	60 K to $<345$ K		

Three-point SoftCal calibrations are performed at liquid helium (4.2 K), liquid nitrogen (77.35 K), and room temperature (305 K). Accuracy for the DT-470-SD-13 diode sensor is as follows:

$\pm 0.5$ K	2 K to $<30$ K	$\pm 0.25$ K	345 K to $<375$ K
$\pm 0.25$ K	30 K to $<60$ K	$\pm 1.0$ K	375 to 475 K
$\pm 0.15$ K	60 K to $<345$ K		

### 5.3.3 SoftCal™ with Platinum Sensors

The platinum sensor is a well-accepted temperature standard because of its consistent and repeatable temperature response above 30 K. SoftCal gives platinum sensors better accuracy than their nominal matching to the DIN 43760 curve.



C-325-5-2.bmp

**Figure 5-2. SoftCal Temperature Ranges for Platinum Sensors**

One, two, or three calibration data points can be used. If using one point, the algorithm shifts the entire curve up or down to meet the single point. If using two points, the algorithm has enough information to tilt the curve, achieving good accuracy between the data points. The third point extends the improved accuracy to span all three points.

**Point 1:** Calibration data point at or near the boiling point of nitrogen (77.35 K). Temperatures outside 50 K to 100 K are not allowed.

**Point 2:** Calibration data point near room temperature (305 K). Temperatures outside 200 K to 350 K are not allowed.

**Point 3:** Calibration data point at a higher temperature (480 K). Temperatures outside 400 K to 600 K are not allowed.

### 5.3.4 SoftCal™ Accuracy with Platinum Sensors

A SoftCal calibration is only as good as the accuracy of the calibration points. The accuracies listed for SoftCal assume  $\pm 0.05$  K for 77.35 K (liquid nitrogen) and 305 K (room temperature) points. Users performing the SoftCal with Lake Shore instruments should note that the boiling point of liquid cryogen, though accurate, is affected by atmospheric pressure. Use calibrated standard sensors if possible.

One-point SoftCal calibrations with platinum sensors have no specified accuracy.

Two-point SoftCal calibrations for applications above 70 K are performed at liquid nitrogen (77.35 K) and room temperature (305 K). Accuracy for the PT-102, PT-103, or PT-111 platinum sensor is as follows:

- $\pm 250$  mK from 70 K to 325 K
- $\approx \pm 500$  mK from 325 K to  $\approx \pm 1400$  mK at 480 K
- (DIN Class A or Class B tolerance)

Three-point SoftCal calibrations are performed at liquid nitrogen (77.35 K), room temperature (305 K), and high temperature (480 K). Accuracy for the PT-102, PT-103, or PT-111 platinum sensor is  $\pm 250$  mK from 70 K to 325 K, and  $\pm 250$  mK from 325 K to 480 K.



### 5.3.5 SoftCal™ Calibration Curve Creation

Once the calibration data points have been obtained, you may create a SoftCal calibration. This example illustrates SoftCal of a DT-470 diode. Press the **Curve Entry** key. Press the ▲ or ▼ key until you see the following display.

```
Select With ▲▼  
SoftCal
```

Press the **Enter** key. You can press the **Escape** key any time during this routine to return to the normal display.

```
Select for Scal ▲▼  
DT-470
```

Use the ▲ or ▼ key to cycle through the sensor type you wish to SoftCal: DT-470, PT-100, and PT-1000. Once the sensor type is selected, press the **Enter** key. You will see the following message.

```
Select Write to ▲▼  
Curve 21 User
```

**NOTE:** The copy routine allows you to overwrite an existing user curve. Please ensure the curve number you are writing to is correct before proceeding with curve copy.

Use the ▲ or ▼ key to select the user curve location where the SoftCal curve will be stored. You can choose any of the user curve locations, 21 through 35. Press the **Enter** key. You will see the following message.

```
Serial #  
0123456789
```

Use the numerical keypad to enter the applicable sensor serial number; to a maximum of 10 digits. For this example, we will enter 0123456789. Press the **Enter** key.

```
Point 1  
+1.62999v 04.1800k
```

**NOTE:** If Point 1 is not being used, press the **Enter** key with both settings at their default value and advance to Point 2.

**SoftCal™ Calibration Curve Creation (Continued)**

Use the numerical keypad to enter the measured data point at or near the boiling point of helium (4.2 K). Temperatures outside the range of 2–10 K are not permitted. The message “Invalid Point. Please Reenter” is displayed if either point is outside the acceptable range. For this example, we will enter 1.62999. Press the **Enter** key. The cursor will jump to the temperature reading. Again use numerical keypad to enter the temperature the measurement was taken at. For this example, we will enter 4.18 K. Press the **Enter** key.

```
Point 2
+1.02111v 77.0000k
```

**NOTE:** If Point 2 is not being used, press the **Enter** key with both settings at their default value and advance to Point 3.

Use the numerical keypad to enter the measured data point at or near the boiling point of nitrogen (77.35 K). Temperatures outside the range of 50–100 K are not permitted. For this example, we will enter 1.02111. Press the **Enter** key. The cursor will jump to the temperature reading. Again use numerical keypad to enter the temperature the measurement was taken at. For this example, we will enter 77 K. Press the **Enter** key.

```
Point 3
+0.51583v 302.500k
```

**NOTE:** If Point 3 is not being used, press the **Enter** key with both settings at their default value to complete the SoftCal calibration.

Use the numerical keypad to enter the measured data point at or near room temperature (305 K). Temperatures outside the range of 200–350 K are not permitted. For this example, we will enter 0.51583. Press the **Enter** key. The cursor will jump to the temperature reading. Again use numerical keypad to enter the temperature at which the measurement was taken. For this example, we will enter 302.5 K. Press the **Enter** key.

The new curve is automatically generated and you will return to the normal display. You can check the new curve using the Edit Curve instructions in Section 5.2.1. The curve is not automatically assigned to either input, so the new curve must be assigned to an input by the user.

# CHAPTER 6

## COMPUTER INTERFACE OPERATION

### 6.0 GENERAL

This chapter provides operational instructions for the computer interface for the Lake Shore Model 325 temperature controller. Either of the two computer interfaces provided with the Model 325 permit remote operation. The first is the IEEE-488 interface described in Section 6.1. The second is the serial interface described in Section 6.2. The two interfaces share a common set of commands detailed in Section 6.3. Only one of the interfaces can be used at a time.

### 6.1 IEEE-488 INTERFACE

The IEEE-488 interface is an instrumentation bus with hardware and programming standards that simplify instrument interfacing. The Model 325 IEEE-488 interface complies with the IEEE-488.2-1987 standard and incorporates its functional, electrical, and mechanical specifications unless otherwise specified in this manual.

All instruments on the interface bus perform one or more of the interface functions of TALKER, LISTENER, or BUS CONTROLLER. A TALKER transmits data onto the bus to other devices. A LISTENER receives data from other devices through the bus. The BUS CONTROLLER designates to the devices on the bus which function to perform. The Model 325 performs the functions of TALKER and LISTENER but cannot be a BUS CONTROLLER. The BUS CONTROLLER is the digital computer that tells the Model 325 which functions to perform.

Below are Model 325 IEEE-488 interface capabilities:

- **SH1:** Source handshake capability.
- **RL1:** Complete remote/local capability.
- **DC1:** Full device clear capability.
- **DT0:** No device trigger capability.
- **C0:** No system controller capability.
- **T5:** Basic TALKER, serial poll capability, talk only, unaddressed to talk if addressed to listen.
- **L4:** Basic LISTENER, unaddressed to listen if addressed to talk.
- **SR1:** Service request capability.
- **AH1:** Acceptor handshake capability.
- **PP0:** No parallel poll capability.
- **E1:** Open collector electronics.

Instruments are connected to the IEEE-488 bus by a 24-conductor connector cable as specified by the standard. Refer to Section 8.7.2. Cables can be purchased from Lake Shore or other electronic suppliers.

Cable lengths are limited to 2 m for each device and 20 m for the entire bus. The Model 325 can drive a bus with up to 10 loads. If more instruments or cable length is required, a bus expander must be used.

#### 6.1.1 Changing IEEE-488 Interface Parameters

Two interface parameters, address and terminators, must be set from the front panel before communication with the instrument can be established. Other interface parameters can be set with device specific commands using the interface (Section 6.3).

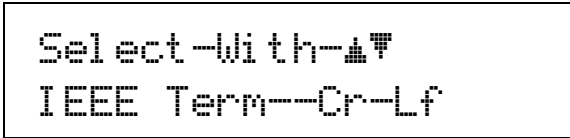
Press the **Interface** key. The first screen is for selecting the serial interface baud rate, and can be skipped by pressing the **Enter** key. The address screen is then displayed as follows.

```

Select-With-▲
IEEE-Address--12
```

**Changing IEEE-488 Interface Parameters (Continued)**

Press the ▲ or ▼ keys to increment or decrement the IEEE address to the desired number. Valid addresses are 1 through 30. Default is 12. Press **Enter** to accept new number or **Escape** to retain the existing number. Pressing **Enter** displays the Terminators screen.



Select With ▲▼  
IEEE Term--Cr-Lf

Press the ▲ or ▼ keys to cycle through the following terminator choices: CR/LF, LF/CR, LF, and EOI. The default is Cr Lf. To accept changes or the currently displayed setting, push **Enter**. To cancel changes, push **Escape**.

**6.1.2 Remote/Local Operation**

Normal operations from the keypad are referred to as 'local' operations. The Model 325 can also be configured for 'remote' operations via the IEEE-488 interface or the **Local** key. The **Local** key will toggle between remote and local operation. During remote operations, the remote annunciator "R" will be displayed in the top right of the LCD display, and operations from the keypad will be disabled.

**6.1.3 IEEE-488 Command Structure**

The Model 325 supports several command types. These commands are divided into three groups.

1. **Bus Control** – Refer to Section 6.1.3.1.
  - a. Universal
    - (1) Uniline
    - (2) Multiline
  - b. Addressed Bus Control
2. **Common** – Refer to Section 6.1.3.2.
3. **Device Specific** – Refer to Section 6.1.3.3.
4. **Message Strings** – Refer to Section 6.1.3.4.

**6.1.3.1 Bus Control Commands**

A universal command addresses all devices on the bus. Universal commands include uniline and multiline commands. A uniline command (message) asserts only a single signal line. The Model 325 recognizes two of these messages from the BUS CONTROLLER: **Remote (REN)** and **Interface Clear (IFC)**. The Model 325 sends one uniline command: **Service Request (SRQ)**.

**REN (Remote)** – Puts the Model 325 into remote mode.

**IFC (Interface Clear)** – Stops current operation on the bus.

**SRQ (Service Request)** – Tells the bus controller that the Model 325 needs interface service.

A multiline command asserts a group of signal lines. All devices equipped to implement such commands do so simultaneously upon command transmission. These commands transmit with the Attention (ATN) line asserted low. The Model 325 recognizes two multiline commands:

**LLO (Local Lockout)** – Prevents the use of instrument front panel controls.

**DCL (Device Clear)** – Clears Model 325 interface activity and puts it into a bus idle state.

Finally, addressed bus control commands are multiline commands that must include the Model 325 listen address before the instrument responds. Only the addressed device responds to these commands. The Model 325 recognizes three of the addressed bus control commands:

**SDC (Selective Device Clear)** – The SDC command performs essentially the same function as the DCL command, except that only the addressed device responds.

**GTL (Go To Local)** – The GTL command is used to remove instruments from the remote mode. With some instruments, GTL also unlocks front panel controls if they were previously locked out with the LLO command.

**SPE (Serial Poll Enable)** and **SPD (Serial Poll Disable)** – Serial polling accesses the Service Request Status Byte Register. This status register contains important operational information from the unit requesting service. The SPD command ends the polling sequence.

### 6.1.3.2 Common Commands

Common Commands are addressed commands that create commonality between instruments on the bus. All instruments that comply with the IEEE-488 1987 standard share these commands and their format. Common commands all begin with an asterisk. They generally relate to “bus” and “instrument” status and identification. Common query commands end with a question mark (?). Model 325 common commands are detailed in Section 6.3 and summarized in Table 6-9.

### 6.1.3.3 Device Specific Commands

Device specific commands are addressed commands. The Model 325 supports a variety of device specific commands to program instruments remotely from a digital computer and to transfer measurements to the computer. Most device specific commands perform functions also performed from the front panel. Model 325 device specific commands are detailed in Section 6.3 and summarized in Table 6-9.

### 6.1.3.4 Message Strings

A message string is a group of characters assembled to perform an interface function. There are three types of message strings: commands, queries and responses. The computer issues command and query strings through user programs, the instrument issues responses. Two or more command strings or queries can be chained together in one communication but they must be separated by a semi-colon (;). The total communication string must not exceed 255 characters in length.

A command string is issued by the computer and instructs the instrument to perform a function or change a parameter setting. When a command is issued, the computer is acting as ‘talker’ and the instrument as ‘listener’. The format is:

**<command mnemonic><space><parameter data><terminators>.**

Command mnemonics and parameter data necessary for each one is described in Section 6.3. Terminators must be sent with every message string.

A query string is issued by the computer and instructs the instrument which response to send. Queries are issued similar to commands with the computer acting as ‘talker’ and the instrument as ‘listener’. The query format is:

**<query mnemonic><?><space><parameter data><terminators>.**

Query mnemonics are often the same as commands with the addition of a question mark. Parameter data is often unnecessary when sending queries. Query mnemonics and parameter data if necessary is described in Section 6.3. Terminators must be sent with every message string. Issuing a query does not initiate a response from the instrument.

A response string is sent by the instrument only when it is addressed as a ‘talker’ and the computer becomes the ‘listener’. The instrument will respond only to the last query it receives. The response can be a reading value, status report or the present value of a parameter. Response data formats are listed along with the associated queries in Section 6.3.

## 6.1.4 Status System

### 6.1.4.1 Overview

The Model 325 implements a status system compliant to the IEEE 488.2 – 1992 standard. The status system provides a method of recording and reporting instrument information and is typically used to control the Service Request (SRQ) interrupt line. A diagram of the status system is shown in Figure 6-1. The status system is made up of register sets, the Status Byte register, and the Service Request Enable register. Each register set consists of three types of registers, condition, event, and enable.

#### 6.1.4.1.1 Condition Registers

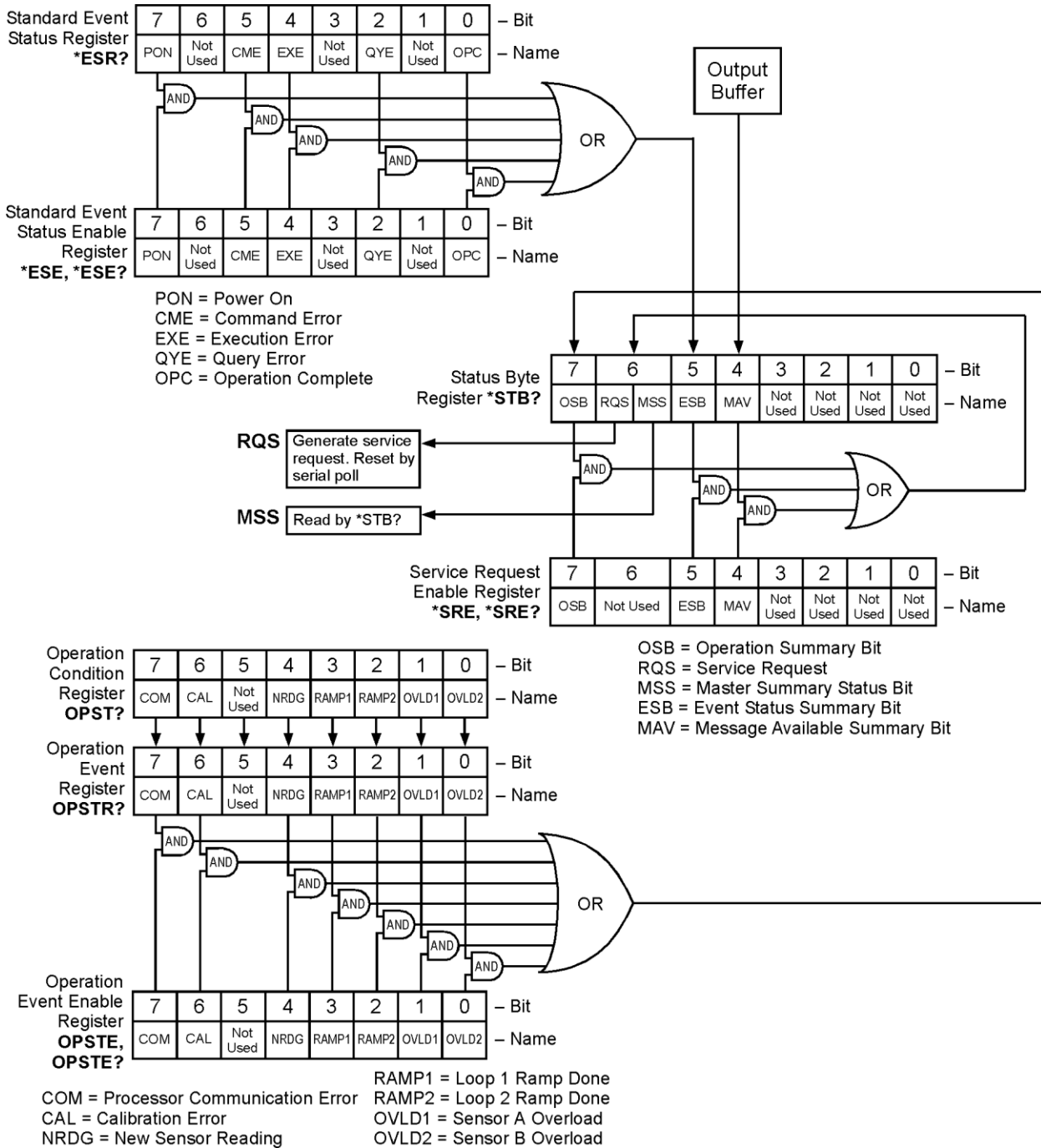
Each register set (except the Standard Event Register set) includes a condition register as shown in Figure 6-1. The condition register constantly monitors the instrument status. The data bits are real-time and are not latched or buffered. The register is read-only.

#### 6.1.4.1.2 Event Registers

Each register set includes an event register as shown in Figure 6-1. Bits in the event register correspond to various system events and latch when the event occurs. When an event bit is set, subsequent events corresponding to that bit are ignored. Set bits remain latched until the register is cleared by a query command (such as \*ESR?) or a \*CLS command. The register is read-only.

### 6.1.4.1.3 Enable Registers

Each register set includes an enable register as shown in Figure 6-1. An enable register determines which bits in the corresponding event register will set the summary bit for the register set in the Status Byte. The user may write to or read from an enable register. Each event register bit is logically ANDed to the corresponding enable bit of the enable register. When an enable register bit is set by the user, and the corresponding bit is set in the event register, the output (summary) of the register will be set, which in turn sets the summary bit of the Status Byte register.



Figure\_6-1.bmp

Figure 6-1. Model 325 Status System

#### 6.1.4.1.4 Status Byte Register

The Status Byte register, typically referred to as the Status Byte, is a non-latching, read-only register that contains all of the summary bits from the register sets. The status of the summary bits are controlled from the register sets as explained above. The Status Byte also contains the Request for Service (RQS)/Master Summary Status (MSS) bit. This bit is used to control the Service Request hardware line on the bus and to report if any of the summary bits are set via the \*STB? command. The status of the RQS/MSS bit is controlled by the summary bits and the Service Request Enable Register.

#### 6.1.4.1.5 Service Request Enable Register

The Service Request Enable Register determines which summary bits in the Status Byte will set the RQS/MSS bit of the Status Byte. The user may write to or read from the Service Request Enable Register. Each Status Byte summary bit is logically ANDed to the corresponding enable bit of the Service Request Enable Register. When a Service Request Enable Register bit is set by the user, and the corresponding summary bit is set in the Status Byte, the RQS/MSS bit of the Status Byte will be set, which in turn sets the Service Request hardware line on the bus.

#### 6.1.4.1.6 Reading Registers

Any register in the status system may be read using the appropriate query command. Some registers clear when read, others do not. Refer to Section 6.1.4.1.8. The response to a query will be a decimal value that corresponds to the binary-weighted sum of all bits in the register (Table 6-1). The actual query commands are described later in this section.

**Table 6-1. Binary Weighting of an 8-Bit Register**

Position	B7	B6	B5	B4	B3	B2	B1	B0
Decimal	128	64	32	16	8	4	2	1
Weighting	$2^7$	$2^6$	$2^5$	$2^4$	$2^3$	$2^2$	$2^1$	$2^0$

Example: If bits 0, 2, and 4 are set, a query of the register will return a decimal value of 21 ( $1+4+16$ ).

#### 6.1.4.1.7 Programming Registers

The only registers that may be programmed by the user are the enable registers. All other registers in the status system are read-only registers. To program an enable register send a decimal value that corresponds to the desired binary-weighted sum of all bits in the register, refer to Table 6-1. The actual commands are described later in this section.

#### 6.1.4.1.8 Clearing Registers

The methods to clear each register are detailed in Table 6-2.

**Table 6-2. Register Clear Methods**

Register	Method	Example
Condition Registers	None — registers are not latched	—
Event Registers:	Query the event register	*ESR? (clears Standard Event Status register)
Standard Event Status Register	Send *CLS	*CLS (clears both registers)
Operation Event Register	Power on instrument	—
Enable Registers:	Write 0 to the enable register	*ESE 0 (clears Standard Event Status Enable register)
Standard Event Status Enable Register	Power on instrument	—
Operation Event Enable Register		
Service Request Enable Register		
Status Byte	There are no commands that directly clear the Status Byte as the bits are non-latching; to clear individual summary bits, clear the event register that corresponds to the summary bit — sending *CLS will clear all event registers which in turn clears the status byte	If bit 5 (ESB) of the Status Byte is set, send *ESR? to read the Standard Event Status Register and bit 5 will clear
	Power on instrument	—

**6.1.4.2 Status Register Sets**

As shown in Figure 6-1, there are two register sets in the status system of the Model 325: Standard Event Status Register and Operation Event Register.

**6.1.4.2.1 Standard Event Status Register Set**

The Standard Event Status Register reports the following interface related instrument events: power on detected, command syntax errors, command execution errors, query errors, operation complete. Any or all of these events may be reported in the standard event summary bit through the enable register, see Figure 6-2. The Standard Event Status Enable command (\*ESE) programs the enable register and the query command (\*ESE?) reads it. \*ESR? reads and clears the Standard Event Status Register. The used bits of the Standard Event Register are described as follows:

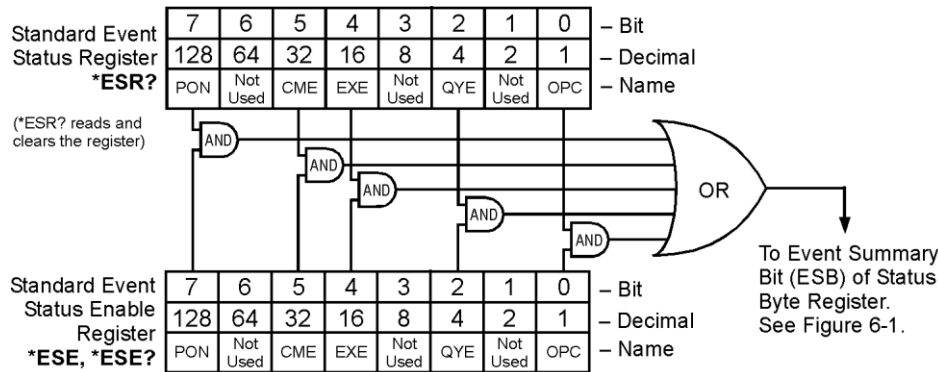
**Power On (PON), Bit (7)** – This bit is set to indicate an instrument off-on transition.

**Command Error (CME), Bit (5)** – This bit is set if a command error has been detected since the last reading. This means that the instrument could not interpret the command due to a syntax error, an unrecognized header, unrecognized terminators, or an unsupported command.

**Execution Error (EXE), Bit (4)** – This bit is set if an execution error has been detected. This occurs when the instrument is instructed to do something not within its capabilities.

**Query Error (QYE), Bit (2)** – This bit indicated a query error. It occurs rarely and involves loss of data because the output queue is full.

**Operation Complete (OPC), Bit (0)** – When \*OPC is sent, this bit will be set when the instrument has completed all pending operations. The operation of this bit is not related to the \*OPC? command, which is a separate interface feature. Refer to Section 6.1.4.3.6 for more information.



Figure\_6-2.bmp

**Figure 6-2. Standard Event Status Register**

**6.1.4.2.2 Operation Event Register Set**

The Operation Event Register reports the following interface related instrument events: ramp done, new reading, overload. Any or all of these events may be reported in the operation event summary bit through the enable register, see Figure 6-3. The Operation Event Enable command (OPSTE) programs the enable register and the query command (OPSTE?) reads it. OPSTR? reads and clears the Operation Event Register. OPST? reads the Operation Condition register. The used bits of the Operation Event Register are described as follows:

**Processor Communication Error (COM), Bit (7)** – This bit is set when the main processor cannot communicate with the sensor input processor.

**Calibration Error (CAL), Bit (6)** – This bit is set if the instrument is not calibrated or the calibration data has been corrupted.

**New Sensor Reading (NRDG), Bit (4)** – This bit is set when there is a new sensor reading.

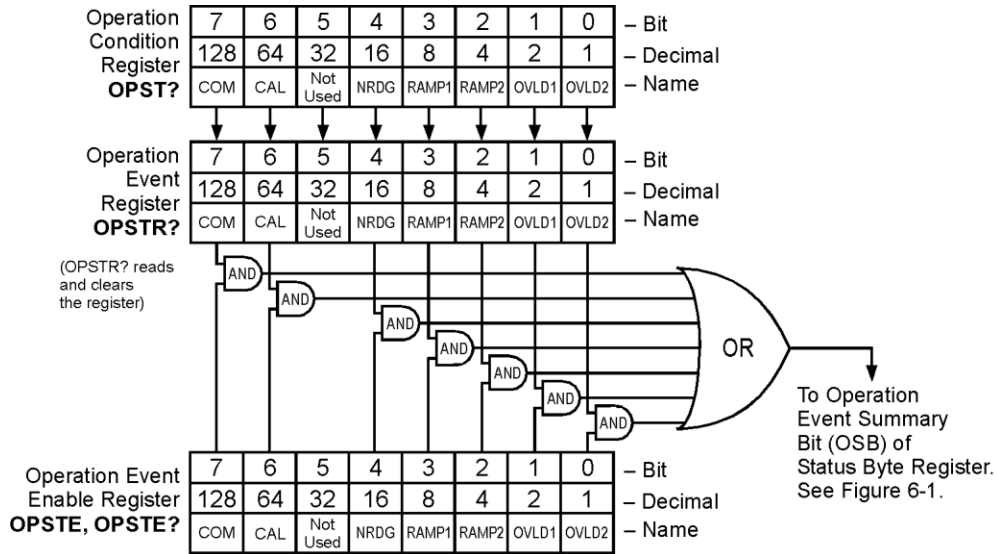
**Loop 1 Ramp Done (RAMP1), Bit (3)** – This bit is set when a loop 1 setpoint ramp is completed.

**Loop 2 Ramp Done (RAMP2), Bit (2)** – This bit is set when a loop 2 setpoint ramp is completed.

**Sensor Overload A (OVL1), Bit (1)** – This bit is set when the sensor A reading is in the overload condition.

**Sensor Overload B (OVL2), Bit (0)** – This bit is set when the sensor B reading is in the overload condition.





Figure\_6-3.bmp

Figure 6-3. Operation Event Register

### 6.1.4.3 Status Byte and Service Request (SRQ)

As shown in Figure 6-1, the Status Byte Register receives the summary bits from the two status register sets and the message available summary bit from the output buffer. The status byte is used to generate a service request (SRQ). The selection of summary bits that will generate an SRQ is controlled by the Service Request Enable Register.

#### 6.1.4.3.1 Status Byte Register

The summary messages from the event registers and output buffer set or clear the summary bits of the Status Byte Register, see Figure 6-4. These summary bits are not latched. Clearing an event register will clear the corresponding summary bit in the Status Byte Register. Reading all messages in the output buffer, including any pending queries, will clear the message available bit. The bits of the Status Byte Register are described as follows:

**Operation Summary (OSB), Bit (7)** – Set summary bit indicates that an enabled operation event has occurred.

**Request Service (RQS)/Master Summary Status (MSS), Bit (6)** – This bit is set when a summary bit and the summary bits corresponding enable bit in the Service Request Enable Register are set. Once set, the user may read and clear the bit in two different ways, which is why it is referred to as both the RQS and the MSS bit. When this bit goes from low to high, the Service Request hardware line on the bus is set, this is the RQS function of the bit. Refer to Section 6.1.4.3.3. In addition, the status of the bit may be read with the \*STB? query, which returns the binary weighted sum of all bits in the Status Byte; this is the MSS function of the bit.

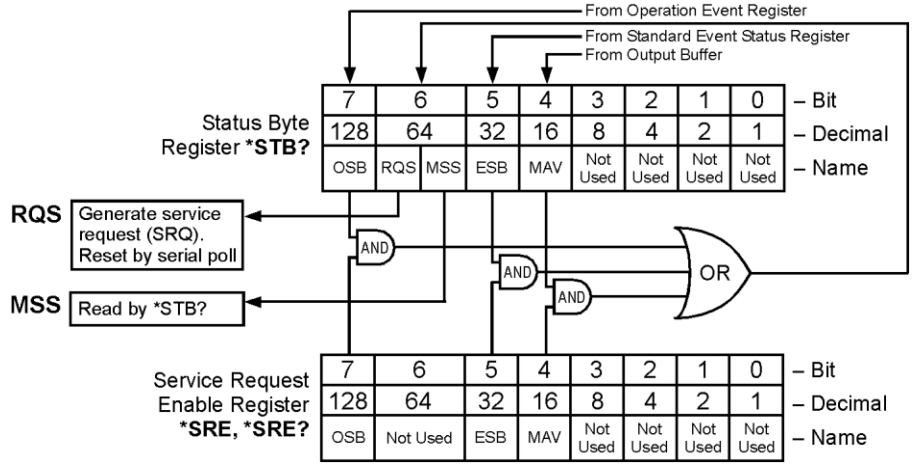
Performing a serial poll will automatically clear the RQS function but not the MSS function. A \*STB? will read the status of the MSS bit (along with all of the summary bits), but also will not clear it. To clear the MSS bit, either clear the event register that set the summary bit or disable the summary bit in the Service Request Enable Register.

**Event Summary (ESB), Bit (5)** – Set summary bit indicates that an enabled standard event has occurred.

**Message Available (MAV), Bit (4)** – Set summary bit indicates that a message is available in the output buffer.

**6.1.4.3.2 Service Request Enable Register**

The Service Request Enable Register is programmed by the user and determines which summary bits of the Status Byte may set bit 6 (RQS/MSS) to generate a Service Request. Enable bits are logically ANDed with the corresponding summary bits, see Figure 6-4. Whenever a summary bit is set by an event register and its corresponding enable bit is set by the user, bit 6 will set to generate a service request. The Service Request Enable command (\*SRE) programs the Service Request Enable Register and the query command (\*SRE?) reads it. Reading the Service Request Enable Register will not clear it. The register may be cleared by the user by sending \*SRE 0.



Figure\_6-4.bmp

**Figure 6-4. Status Byte Register and Service Request Enable Register**

**6.1.4.3.3 Using Service Request (SRQ) and Serial Poll**

When a Status Byte summary bit (or MAV bit) is enabled by the Service Request Enable Register and goes from 0 to 1, bit 6 (RQS/MSS) of the status byte will be set. This will send a service request (SRQ) interrupt message to the bus controller. The user program may then direct the bus controller to serial Poll the instruments on the bus to identify which one requested service (the one with bit 6 set in its status byte).

Serial polling will automatically clear RQS of the Status Byte Register. This allows subsequent serial polls to monitor bit 6 for an SRQ occurrence generated by other event types. After a serial poll, the same event or any event that uses the same Status Byte summary bit, will not cause another SRQ unless the event register that caused the first SRQ has been cleared, typically by a query of the event register.

The serial poll does not clear MSS. The MSS bit stays set until all enabled Status Byte summary bits are cleared, typically by a query of the associated event register — refer to Section 6.1.4.3.4.

The programming example in Table 6-3 initiates an SRQ when a command error is detected by the instrument.

**Table 6-3. Programming Example to Generate an SRQ**

<i>Command or Operation</i>	<i>Description</i>
*ESR?	Read and clear the Standard Event Status Register.
*ESE 32	Enable the Command Error (CME) bit in the Standard Event Status Register
*SRE 32	Enable the Event Summary Bit (ESB) to set the RQS
*ABC	Send improper command to instrument to generate a command error
Monitor bus	Monitor the bus until the Service Request interrupt (SRQ) is sent.
Initiate Serial Poll	Serial Poll the bus to determine which instrument sent the interrupt and clear the RQS bit in the Status Byte.
*ESR?	Read and clear the Standard Event Status Register allowing an SRQ to be generated on another command error.

**6.1.4.3.4 Using Status Byte Query (\*STB?)**

The Status Byte Query (\*STB?) command is similar to a Serial Poll except it is processed like any other instrument command. The \*STB? command returns the same result as a Serial Poll except that the Status Byte bit 6 (RQS/MSS) is not cleared. In this case bit 6 is considered the MSS bit. Using the \*STB? command does not clear any bits in the Status Byte Register.

**6.1.4.3.5 Using the Message Available (MAV) bit**

Status Byte summary bit 4 (MAV) indicates that data is available to read into your bus controller. This message may be used to synchronize information exchange with the bus controller. The bus controller can, for example, send a query command to the Model 325 and then wait for MAV to set. If the MAV bit has been enabled to initiate an SRQ, the user's program can direct the bus controller to look for the SRQ leaving the bus available for other use. The MAV bit will be clear whenever the output buffer is empty.

**6.1.4.3.6 Using Operation Complete (\*OPC) and Operation Complete Query (\*OPC?)**

The Operation Complete (\*OPC) and Operation Complete Query (\*OPC?) are both used to indicate when pending device operations complete. However, the commands operate with two distinct methods.

The \*OPC command is used in conjunction with bit 0 (OPC) of the Standard Event Status Register. If \*OPC is sent as the last command in a command sequence, bit 0 will be set when the instrument completes the operation that was initiated by the command sequence. Additional commands may be sent between the instrument and the bus controller while waiting for the initial pending operation to complete. A typical use of this function would be to enable the OPC bit to generate an SRQ and include the \*OPC command when programming the instrument. The bus controller could then be instructed to look for an SRQ allowing additional communication with the instrument while the initial process executes.

The \*OPC? query has no interaction with bit 0 (OPC) of the Standard Event Status Register. If the \*OPC? query is sent at the end of a command sequence, the bus will be held until the instrument completes the operation that was initiated by the command sequence. Additional commands (except \*RST) should not be sent until the operation is complete, as erratic operation will occur. Once the sequence is complete a 1 will be placed in the output buffer. This function is typically used to signal a completed operation without monitoring the SRQ. It is also used when it is important to prevent any additional communication on the bus during a pending operation.

### 6.1.5 IEEE Interface Example Program

A Visual Basic program is included to illustrate the IEEE-488 communication functions of the instrument. Instructions for setting up the IEEE-488 board is included in Section 6.1.5.1. Refer to Section 6.1.5.2 for instructions on how to setup the program. The Visual Basic code is provided in Table 6-2. A description of program operation is provided in Section 6.1.5.3. While the hardware and software required to produce and implement these programs is not included with the instrument, the concepts illustrated apply to most applications.

#### 6.1.5.1 IEEE-488 Interface Board Installation for Visual Basic Program

This procedure works for plug and play General Purpose Interface Board (GPIB) hardware and software for Windows 98/95. This example uses the AT-GPIB/TNT GPIB card.

1. Install the GPIB plug and play software and hardware using National Instruments instructions.
2. Verify that the following files have been installed to the Windows System folder:
  - a. gpib-32.dll
  - b. gpib.dll
  - c. gpib32ft.dllFiles b and c will support 16-bit Windows GPIB applications if any are being used.
3. Locate the following files and make note of their location. These files will be used during the development process of a Visual Basic program.
  - a. Niglobal.bas
  - b. Vbib-32.bas

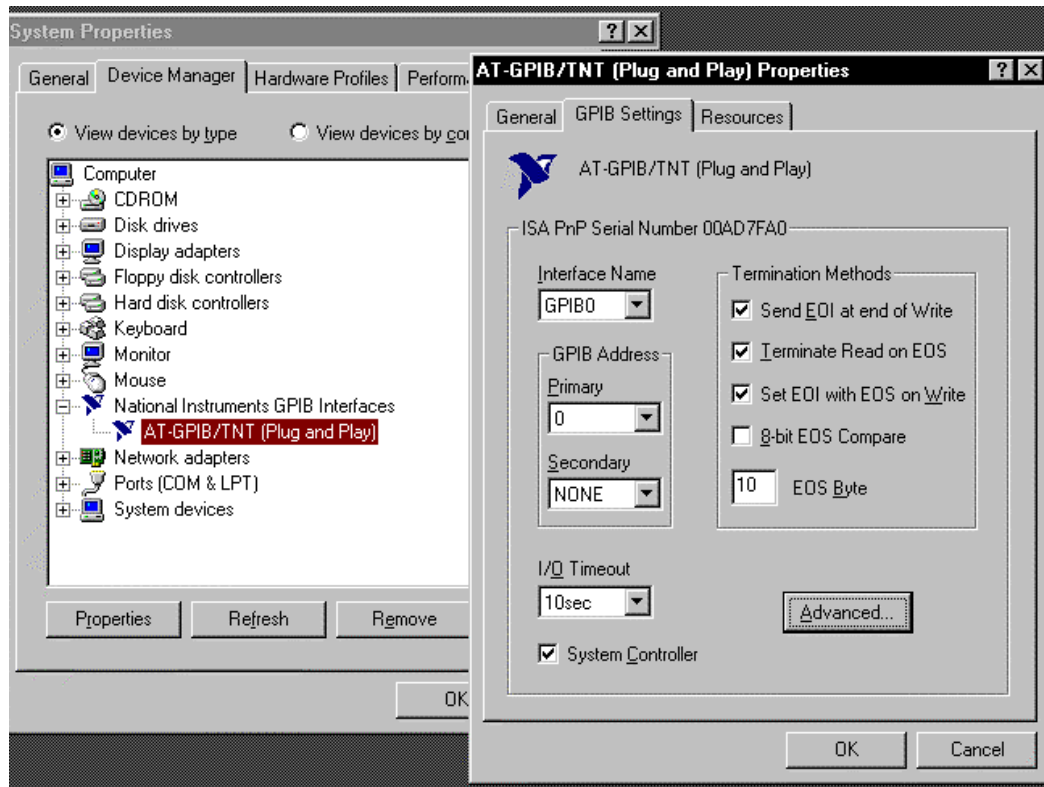
**NOTE:** If the files in Steps 2 and 3 are not installed on your computer, they may be copied from your National Instruments setup disks or they may be downloaded from [www.ni.com](http://www.ni.com).

4. Configure the GPIB by selecting the System icon in the Windows 98/95 Control Panel located under Settings on the Start Menu. Configure the GPIB Settings as shown in Figure 6-5. Configure the DEV12 Device Template as shown in Figure 6-6. Be sure to check the Readdress box.

#### 6.1.5.2 Visual Basic IEEE-488 Interface Program Setup

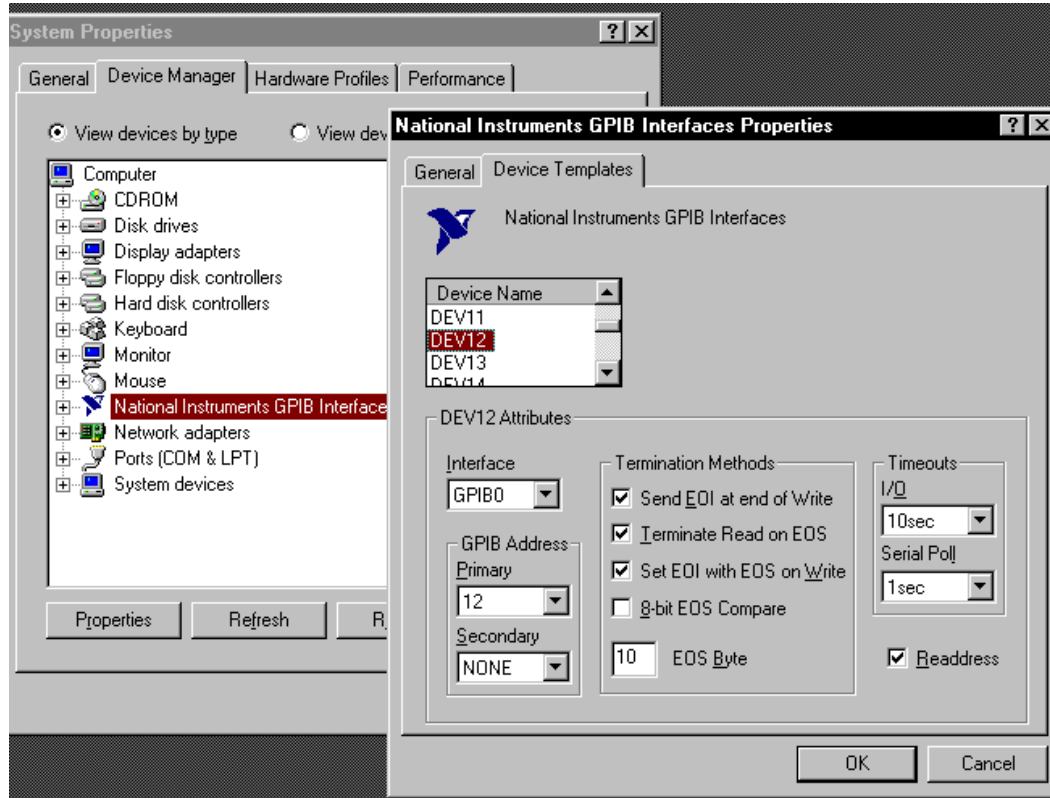
This IEEE-488 interface program works with Visual Basic 6.0 (VB6) on an IBM PC (or compatible) with a Pentium-class processor. A Pentium 90 or higher is recommended, running Windows 95 or better. It assumes your IEEE-488 (GPIB) card is installed and operating correctly (refer to Section 6.1.5.1). Use the following procedure to develop the IEEE-488 Interface Program in Visual Basic.

1. Start VB6.
2. Choose Standard EXE and select Open.
3. Resize form window to desired size.
4. On the Project Menu, select Add Module, select the Existing tab, then navigate to the location on your computer to add the following files: Niglobal.bas and Vbib-32.bas.
5. Add controls to form:
  - a. Add three Label controls to the form.
  - b. Add two TextBox controls to the form.
  - c. Add one CommandButton control to the form.
6. On the View Menu, select Properties Window.



VB\_GPIB\_1.bmp

Figure 6-5. GPIB Setting Configuration

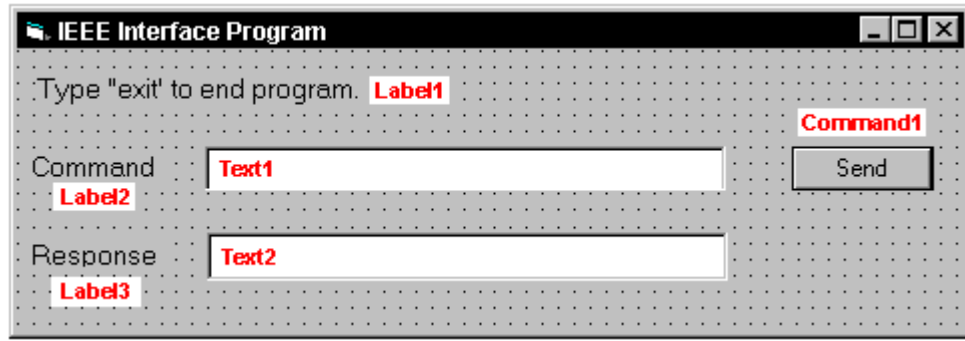


VB\_GPIB\_2.bmp

Figure 6-6. DEV 12 Device Template Configuration

**Visual Basic IEEE-488 Interface Program Setup (Continued)**

7. In the Properties window, use the dropdown list to select between the different controls of the current project.
8. Set the properties of the controls as defined in Table 6-4.
9. Save the program.



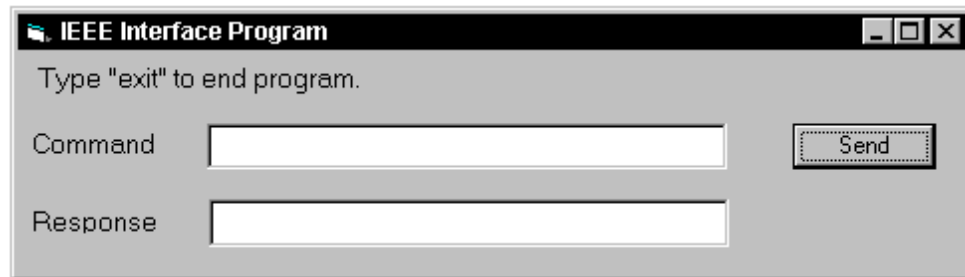
VB\_GPIB\_3.bmp

**Table 6-4. IEEE-488 Interface Program Control Properties**

<i>Current Name</i>	<i>Property</i>	<i>New Value</i>
Label1	Name Caption	lblExitProgram Type "exit" to end program.
Label2	Name Caption	lblCommand Command
Label3	Name Caption	lblResponse Response
Text1	Name Text	txtCommand <blank>
Text2	Name Text	txtResponse <blank>
Command1	Name Caption Default	cmdSend Send True
Form1	Name Caption	frmIEEE IEEE Interface Program

10. Add code (provided in Table 6-5).
  - a. In the Code Editor window, under the Object dropdown list, select (General). Add the statement: Public gSend as Boolean
  - b. Double Click on cmdSend. Add code segment under Private Sub cmdSend\_Click() as shown in Table 6-5.
  - c. In the Code Editor window, under the Object dropdown list, select Form. Make sure the Procedure dropdown list is set at Load. The Code window should have written the segment of code: Private Sub Form\_Load(). Add the code to this subroutine as shown in Table 6-5.

11. Save the program.
12. Run the program. The program should resemble the window to the right.



VB\_GPIB\_4.bmp

13. Type in a command or query in the Command box as described in Section 6.1.5.5.
14. Press Enter or select the Send button with the mouse to send command.
15. Type Exit and press Enter to quit.

Table 6-5. Visual Basic IEEE-488 Interface Program

Public gSend As Boolean	'Global used for Send button state
Private Sub cmdSend_Click() gSend = True End Sub	'Routine to handle Send button press 'Set Flag to True
Private Sub Form_Load() Dim strReturn As String Dim term As String Dim strCommand As String Dim intDevice As Integer  frmIEEE.Show term = Chr(13) & Chr(10) strReturn = ""  Call ibdev(0, 12, 0, T10s, 1, &H140A, intDevice) Do Do DoEvents Loop Until gSend = True gSend = False  strCommand = frmIEEE.txtCommand.Text strReturn = ""  strCommand = UCase(strCommand) If strCommand = "EXIT" Then End End If  Call ibwrt(intDevice, strCommand & term) If (ibsta And EERR) Then 'do error handling if needed End If  If InStr(strCommand, "?") <> 0 Then strReturn = Space(100) Call ibrd(intDevice, strReturn) If (ibsta And EERR) Then 'do error handling if needed End If  If strReturn <> "" Then strReturn = RTrim(strReturn) Do While Right(strReturn, 1) = Chr(10) Or Right(strReturn, 1) = Chr(13) strReturn = Left(strReturn, Len(strReturn) - 1) Loop Else strReturn = "No Response" End If  frmIEEE.txtResponse.Text = strReturn End If Loop End Sub	'Main code section 'Used to return response 'Terminators 'Data string sent to instrument 'Device number used with IEEE  'Show main window 'Terminators are <CR><LF> 'Clear return string  'Initialize the IEEE device  'Wait loop 'Give up processor to other events 'Loop until Send button pressed 'Set Flag as False  'Get Command 'Clear response display  'Set all characters to upper case 'Get out on EXIT  'Send command to instrument 'Check for IEEE errors 'Handle errors here  'Check to see if query 'Build empty return buffer 'Read back response 'Check for IEEE errors 'Handle errors here  'Check if empty string 'Remove extra spaces and Terminators  'Send No Response  'Put response in text on main form

### 6.1.5.3 Program Operation

Once the program is running, try the following commands and observe the response of the instrument. Input from the user is shown in **bold** and terminators are added by the program. The word [term] indicates the required terminators included with the response.

ENTER COMMAND? <b>*IDN?</b>	Identification query. Instrument will return a string identifying itself.
RESPONSE: LSCI,MODEL325,1234567,1.0/1.0 [term]	
ENTER COMMAND? <b>KRDG?</b>	Temperature reading in kelvin query. Instrument will return a string with the present temperature reading.
RESPONSE: +273.15 [term]	
ENTER COMMAND? <b>RANGE 1,0</b>	Heater range command. Instrument will turn off the Loop 1 heater. No response will be sent.
ENTER COMMAND? <b>RANGE? 1</b>	Heater range query. Instrument will return a string with the present Loop 1 heater range setting.
RESPONSE: 0 [term]	
ENTER COMMAND? <b>RANGE 1,1;RANGE? 1</b>	Heater range command followed by a query. Instrument will change to Loop 1 heater Low setting then return a string with the present setting.
RESPONSE: 1 [term]	

The following are additional notes on using either IEEE-488 Interface program.

- If you enter a correctly spelled query without a “?”, nothing will be returned. Incorrectly spelled commands and queries are ignored. Commands and queries should have a space separating the command and associated parameters.
- Leading zeros and zeros following a decimal point are not needed in a command string, but are sent in response to a query. A leading “+” is not required but a leading “-” is required.

### 6.1.6 Troubleshooting

#### *New Installation*

1. Check instrument address.
2. Always send terminators.
3. Send entire message string at one time including terminators.
4. Send only one simple command at a time until communication is established.
5. Be sure to spell commands correctly and use proper syntax.
6. Attempt both 'Talk' and 'Listen' functions. If one works but not the other, the hardware connection is working, so look at syntax, terminators, and command format.
7. If only one message is received after resetting the interface, check the “repeat addressing” setting. It should be enabled.

#### *Old Installation No Longer Working*

1. Power instrument off then on again to see if it is a soft failure.
2. Power computer off then on again to see if the IEEE card is locked up.
3. Verify that the address has not been changed on the instrument during a memory reset.
4. Check all cable connections.

#### *Intermittent Lockups*

1. Check cable connections and length.
2. Increase delay between all commands to 50 ms to make sure instrument is not being overloaded.



## 6.2 SERIAL INTERFACE OVERVIEW

The serial interface used in the Model 325 is commonly referred to as an RS-232C interface. RS-232C is a standard of the Electronics Industries Association (EIA) that describes one of the most common interfaces between computers and electronic equipment. The RS-232C standard is quite flexible and allows many different configurations. However, any two devices claiming RS-232C compatibility cannot necessarily be plugged together without interface setup. The remainder of this section briefly describes the key features of a serial interface that are supported by the instrument. A customer-supplied computer with similarly configured interface port is required to enable communication.

### 6.2.1 Physical Connection

The Model 325 has a 9-pin D-subminiature plug on the rear panel for serial communication. The original RS-232C standard specifies 25 pins but both 9- and 25-pin connectors are commonly used in the computer industry. Many third party cables exist for connecting the instrument to computers with either 9- or 25-pin connectors. Section 8.7.1 gives the most common pin assignments for 9- and 25-pin connectors. Please note that not all pins or functions are supported by the Model 325.

The instrument serial connector is the plug half of a mating pair and must be matched with a socket on the cable. If a cable has the correct wiring configuration but also has a plug end, a “gender changer” can be used to mate two plug ends together.

The letters DTE near the interface connector stand for Data Terminal Equipment and indicate the pin connection of the directional pins such as transmit data (TD) and receive data (RD). Equipment with Data Communications Equipment (DCE) wiring can be connected to the instrument with a straight through cable. As an example, Pin 3 of the DTE connector holds the transmit line and Pin 3 of the DCE connector holds the receive line so the functions complement.

It is likely both pieces of equipment are wired in the DTE configuration. In this case Pin 3 on one DTE connector (used for transmit) must be wired to Pin 2 on the other (used for receive). Cables that swap the complementing lines are called null modem cables and must be used between two DTE wired devices. Null modem adapters are also available for use with straight through cables. Section 8.7.1 illustrates suggested cables that can be used between the instrument and common computers.

The instrument uses drivers to generate the transmission voltage levels required by the RS-232C standard. These voltages are considered safe under normal operating conditions because of their relatively low voltage and current limits. The drivers are designed to work with cables up to 50 feet in length.

### 6.2.2 Hardware Support

The Model 325 interface hardware supports the following features. Asynchronous timing is used for the individual bit data within a character. This timing requires start and stop bits as part of each character so the transmitter and receiver can resynchronize between each character.

Half duplex transmission allows the instrument to be either a transmitter or a receiver of data but not both at the same time. Communication speeds of 9600, 19200, 38400, 57600 baud are supported. The baud rate is the only interface parameter that can be changed by the user.

Hardware handshaking is not supported by the instrument. Handshaking is often used to guarantee that data message strings do not collide and that no data is transmitted before the receiver is ready. In this instrument, appropriate software timing substitutes for hardware handshaking. User programs must take full responsibility for flow control and timing as described in Section 6.2.5.

**Table 6-6. Serial Interface Specifications**

Connector Type:	9-pin D-style connector plug
Connector Wiring:	DTE
Voltage Levels:	EIA RS-232C specified
Transmission Distance:	50 ft maximum
Timing Format:	Asynchronous
Transmission Mode:	Half duplex
Baud Rate:	9600, 19200, 38400, 57600
Handshake:	Software timing
Character Bits:	1 start, 7 data, 1 parity, 1 stop
Parity:	Odd
Terminators:	CR(0DH) LF(0AH)
Command Rate:	20 commands per second maximum

### 6.2.3 Character Format

A character is the smallest piece of information that can be transmitted by the interface. Each character is 10 bits long and contains data bits, bits for character timing and an error detection bit. The instrument uses 7 bits for data in the ASCII format. One start bit and one stop bit are necessary to synchronize consecutive characters. Parity is a method of error detection. One parity bit configured for odd parity is included in each character.

ASCII letter and number characters are used most often as character data. Punctuation characters are used as delimiters to separate different commands or pieces of data. Two special ASCII characters, carriage return (CR 0DH) and line feed (LF 0AH), are used to indicate the end of a message string.

### 6.2.4 Message Strings

A message string is a group of characters assembled to perform an interface function. There are three types of message strings commands, queries and responses. The computer issues command and query strings through user programs, the instrument issues responses. Two or more command strings can be chained together in one communication but they must be separated by a semi-colon (;). Only one query is permitted per communication but it can be chained to the end of a command. The total communication string must not exceed 64 characters in length.

A command string is issued by the computer and instructs the instrument to perform a function or change a parameter setting. The format is:

**<command mnemonic><space><parameter data><terminators>.**

Command mnemonics and parameter data necessary for each one is described in Section 6.3. Terminators must be sent with every message string.

A query string is issued by the computer and instructs the instrument to send a response. The query format is:

**<query mnemonic><?><space><parameter data><terminators>.**

Query mnemonics are often the same as commands with the addition of a question mark. Parameter data is often unnecessary when sending queries. Query mnemonics and parameter data if necessary is described in Section 6.3. Terminators must be sent with every message string. The computer should expect a response very soon after a query is sent.

A response string is the instruments response or answer to a query string. The instrument will respond only to the last query it receives. The response can be a reading value, status report or the present value of a parameter. Response data formats are listed along with the associated queries in Section 6.3. The response is sent as soon as possible after the instrument receives the query. Typically it takes 10 ms for the instrument to begin the response. Some responses take longer.

### 6.2.5 Message Flow Control

It is important to remember that the user program is in charge of the serial communication at all times. The instrument cannot initiate communication, determine which device should be transmitting at a given time or guarantee timing between messages. All of this is the responsibility of the user program.

When issuing commands only the user program should:

- Properly format and transmit the command including terminators as one string.
- Guarantee that no other communication is started for 50 ms after the last character is transmitted.
- Not initiate communication more than 20 times per second.

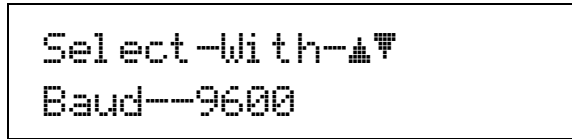
When issuing queries or queries and commands together the user program should:

- Properly format and transmit the query including terminators as one string.
- Prepare to receive a response immediately.
- Receive the entire response from the instrument including the terminators.
- Guarantee that no other communication is started during the response or for 50 ms after it completes.
- Not initiate communication more than 20 times per second.

Failure to follow these simple rules will result in inability to establish communication with the instrument or intermittent failures in communication.

## 6.2.6 Changing Baud Rate

To use the Serial Interface, you must first set the baud rate. Press **Interface** key to display the following screen.



Press the ▲ or ▼ key to cycle through the choices of 9600, 19200, 38400, 57600 baud. Press the **Enter** key to accept the new number.

## 6.2.7 Serial Interface Example Program

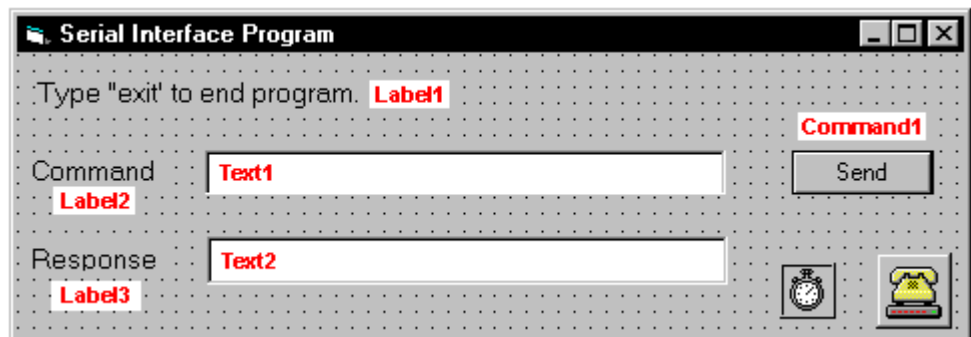
A Visual Basic program is included to illustrate the serial communication functions of the instrument. Refer to Section 6.2.7.1 for instructions on how to setup the program. The Visual Basic code is provided in Table 6-8.

A description of program operation is provided in Section 6.2.7.2. While the hardware and software required to produce and implement these programs not included with the instrument, the concepts illustrated apply to most applications.

### 6.2.7.1 Visual Basic Serial Interface Program Setup

The serial interface program works with Visual Basic 6.0 (VB6) on an IBM PC (or compatible) with a Pentium-class processor. A Pentium 90 or higher is recommended, running Windows 95 or better, with a serial interface. It uses the COM1 communications port at 9600 baud. Use the following procedure to develop the serial interface program in Visual Basic.

1. Start VB6.
2. Choose Standard EXE and select Open.
3. Resize form window to desired size.
4. On the Project Menu, click Components to bring up a list of additional controls available in VB6.
5. Scroll through the controls and select Microsoft Comm Control 6.0. Select OK. In the toolbar at the left of the screen, the Comm Control will have appeared as a telephone icon.
6. Select the Comm control and add it to the form.
7. Add controls to form:
  - a. Add three Label controls to the form.
  - b. Add two TextBox controls to the form.
  - c. Add one CommandButton control to the form.
  - d. Add one Timer control to the form.
8. On the View Menu, select Properties Window.
9. In the Properties window, use the dropdown list to select between the different controls of the current project.
10. Set the properties of the controls as defined in Table 6-7.
11. Save the program.

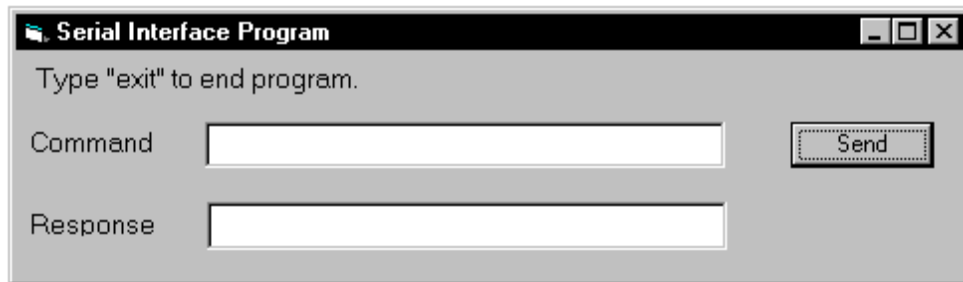


VB\_Serial\_1.bmp

**Table 6-7. Serial Interface Program Control Properties**

Current Name	Property	New Value
Label1	Name Caption	lblExitProgram Type "exit" to end program.
Label2	Name Caption	lblCommand Command
Label3	Name Caption	lblResponse Response
Text1	Name Text	txtCommand <blank>
Text2	Name Text	txtResponse <blank>
Command1	Name Caption Default	cmdSend Send True
Form1	Name Caption	frmSerial Serial Interface Program
Timer1	Enabled Interval	False 10

12. Add code (provided in Table 6-8).
  - a. In the Code Editor window, under the Object dropdown list, select (General). Add the statement: Public gSend as Boolean.
  - b. Double click on cmdSend. Add code segment under Private Sub cmdSend\_Click( ) as shown in Table 6-8.
  - c. In the Code Editor window, under the Object dropdown list, select Form. Make sure the Procedure dropdown list is set at Load. The Code window should have written the segment of code: Private Sub Form\_Load( ). Add the code to this subroutine as shown in Table 6-8.
  - d. Double click on the Timer control. Add code segment under Private Sub Timer1\_Timer() as shown in Table 6-8.
  - e. Make adjustments to code if different com port settings are being used.
13. Save the program.
14. Run the program.  
The program should resemble the window to the right.
15. Type in a command or query in the Command box as described in Section 6.2.7.3.
16. Press Enter or select the Send button with the mouse to send command.
17. Type Exit and press Enter to quit.



VB\_Serial\_2.bmp

Table 6-8. Visual Basic Serial Interface Program

Public gSend As Boolean	'Global used for Send button state
Private Sub cmdSend_Click() gSend = True End Sub	'Routine to handle Send button press 'Set Flag to True
Private Sub Form_Load() Dim strReturn As String Dim strHold As String Dim Term As String Dim ZeroCount As Integer Dim strCommand As String  frmSerial.Show Term = Chr(13) & Chr(10) ZeroCount = 0 strReturn = "" strHold = "" If frmSerial.MSComm1.PortOpen = True Then frmSerial.MSComm1.PortOpen = False End If frmSerial.MSComm1.CommPort = 1 frmSerial.MSComm1.Settings = "9600,o,7,1" frmSerial.MSComm1.InputLen = 1 frmSerial.MSComm1.PortOpen = True  Do Do DoEvents Loop Until gSend = True gSend = False  strCommand = frmSerial.txtCommand.Text strReturn = ""  strCommand = UCase(strCommand) If strCommand = "EXIT" Then End End If  frmSerial.MSComm1.Output = strCommand & Term If InStr(strCommand, "?") <> 0 Then While (ZeroCount < 20) And (strHold <> Chr\$(10)) If frmSerial.MSComm1.InBufferCount = 0 Then frmSerial.Timer1.Enabled = True Do DoEvents Loop Until frmSerial.Timer1.Enabled = False ZeroCount = ZeroCount + 1 Else ZeroCount = 0 strHold = frmSerial.MSComm1.Input strReturn = strReturn + strHold End If Wend  If strReturn <> "" Then strReturn = Mid(strReturn, 1, InStr(strReturn, Term) - 1) 'Strip terminators Else strReturn = "No Response" End If frmSerial.txtResponse.Text = strReturn strHold = "" ZeroCount = 0 End If Loop End Sub	'Main code section 'Used to return response 'Temporary character space 'Terminators 'Counter used for Timing out 'Data string sent to instrument  'Show main window 'Terminators are <CR><LF> 'Initialize counter 'Clear return string 'Clear holding string 'Close serial port to change settings  'Example of Comm 1 'Example of 9600 Baud,Parity,Data,Stop 'Read one character at a time 'Open port  'Wait loop 'Give up processor to other events 'Loop until Send button pressed 'Set Flag as false  'Get Command 'Clear response display  'Set all characters to upper case 'Get out on EXIT  'Send command to instrument 'Check to see if query 'Wait for response 'Add 1 to timeout if no character  'Wait for 10 millisecond timer 'Timeout at 2 seconds  'Reset timeout for each character 'Read in one character 'Add next character to string  'Get characters until terminators  'Check if string empty 'Strip terminators  'Send No Response  'Put response in textbox on main form 'Reset holding string 'Reset timeout counter
Private Sub Timer1_Timer() frmSerial.Timer1.Enabled = False End Sub	'Routine to handle Timer interrupt 'Turn off timer

### 6.2.7.2 Program Operation

Once the program is running, try the following commands and observe the response of the instrument. Input from the user is shown in **bold** and terminators are added by the program. The word [term] indicates the required terminators included with the response.

ENTER COMMAND? <b>*IDN?</b>	Identification query. Instrument will return a string identifying itself.
RESPONSE: LSCI,MODEL325,1234567,1.0/1.0 [term]	
ENTER COMMAND? <b>KRDG?</b>	Temperature reading in kelvin query. Instrument will return a string with the present temperature reading.
RESPONSE: +273.15 [term]	
ENTER COMMAND? <b>RANGE 0</b>	Heater range command. Instrument will turn off the heater. No response will be sent.
ENTER COMMAND? <b>RANGE?</b>	Heater range query. Instrument will return a string with the present heater range setting.
RESPONSE: 0 [term]	
ENTER COMMAND? <b>RANGE 1;RANGE?</b>	Heater range command followed by a query. Instrument will change to heater Low setting then return a string with the present setting.
RESPONSE: 1 [term]	

The following are additional notes on using either serial interface program.

- If you enter a correctly spelled query without a “?” nothing will be returned. Incorrectly spelled commands and queries are ignored. Commands and queries should have a space separating the command and associated parameters.
- Leading zeros and zeros following a decimal point are not needed in a command string, but they will be sent in response to a query. A leading “+” is not required but a leading “-” is required.

### 6.2.8 Troubleshooting

#### *New Installation*

1. Check instrument baud rate.
2. Make sure transmit (TD) signal line from the instrument is routed to receive (RD) on the computer and vice versa. (Use a null modem adapter if not.)
3. Always send terminators.
4. Send entire message string at one time including terminators. (Many terminal emulation programs do not.)
5. Send only one simple command at a time until communication is established.
6. Be sure to spell commands correctly and use proper syntax.

#### *Old Installation No Longer Working*

1. Power instrument off then on again to see if it is a soft failure.
2. Power computer off then on again to see if communication port is locked up.
3. Verify that baud rate has not been changed on the instrument during a memory reset.
4. Check all cable connections.

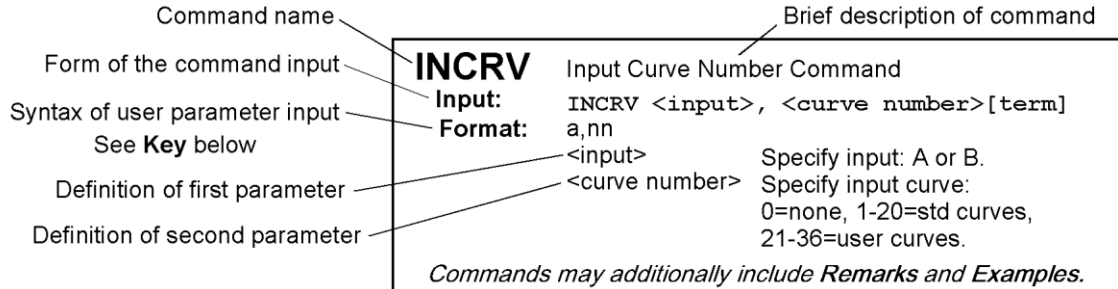
#### *Intermittent Lockups*

1. Check cable connections and length.
2. Increase delay between all commands to 100 ms to make sure instrument is not being overloaded.

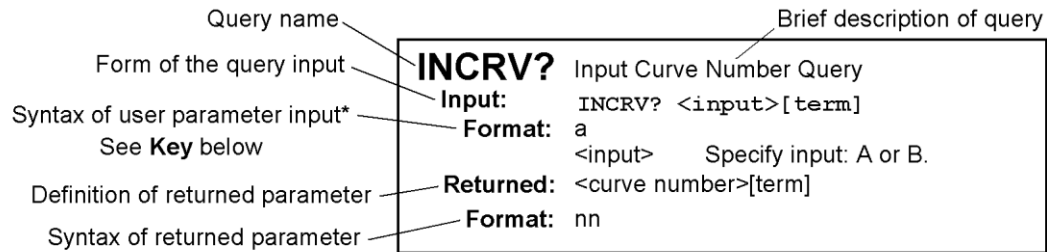
### 6.3 COMMAND SUMMARY

This section provides a listing of the IEEE-488 and serial interface commands. A summary of all the commands is provided in Table 6-9. All the commands are detailed in Section 6.3.1, which is presented in alphabetical order.

#### Sample Command Format



#### Sample Query Format



*The initial **Format** definition is omitted for queries that do not require parameter input.*

#### Key

- \*** Begins common interface command.
- ?** Required to identify queries.
- aa... String of alphanumeric characters.
- nn... String of number characters that may include a decimal point.
- [term] Terminator characters.
- <...> Indicated a parameter field, many are command specific.
- <state> Parameter field with only On/Off or Enable/Disable states.
- <value> Floating point values have varying resolution depending on the type of command or query issued.

**Table 6-9. Command Summary**

<b><u>Command</u></b>	<b><u>Function</u></b>	<b><u>Page</u></b>	<b><u>Command</u></b>	<b><u>Function</u></b>	<b><u>Page</u></b>
*CLS	Clear Interface Cmd .....	6-23	IEEE?	IEEE Interface Parameter Query .....	6-29
*ESE	Event Status Enable Cmd .....	6-23	INCRV	Input Curve Number Cmd .....	6-29
*ESE?	Event Status Enable Query .....	6-23	INCRV?	Input Curve Number Query .....	6-29
*ESR?	Event Status Register Query .....	6-23	INTYPE	Input Type Parameter Cmd .....	6-29
*IDN?	Identification Query .....	6-23	INTYPE?	Input Type Parameter Query .....	6-29
*OPC	Operation Complete Cmd .....	6-24	KEYST?	Keypad Status Query .....	6-30
*OPC?	Operation Complete Query .....	6-24	KRDG?	Kelvin Reading Query .....	6-30
*RST	Reset Instrument Cmd .....	6-24	LOCK	Front Panel Keyboard Lock Cmd .....	6-30
*SRE	Service Request Enable Cmd .....	6-24	LOCK?	Front Panel Keyboard Lock Query .....	6-30
*SRE?	Service Request Enable Query .....	6-24	MODE	Set Local/Remote Mode .....	6-30
*STB?	Status Byte Query .....	6-24	MODE?	Query Local/Remote Mode .....	6-30
*TST?	Self-Test Query .....	6-25	MOUT	Control Loop MHP Output Cmd .....	6-31
*WAI	Wait-To-Continue Cmd .....	6-25	MOUT?	Control Loop MHP Output Query .....	6-31
CMODE	Control Loop Mode Cmd .....	6-25	PID	Control Loop PID Values Cmd .....	6-31
CMODE?	Control Loop Mode Query .....	6-25	PID?	Control Loop PID Values Query .....	6-31
CRDG?	Celsius Reading Query .....	6-25	RAMP	Control Loop Ramp Cmd .....	6-31
CRVDEL	Delete User Curve Cmd .....	6-25	RAMP?	Control Loop Ramp Query .....	6-32
CRVHDR	Curve Header Cmd .....	6-26	RAMPST?	Control Loop Ramp Status Query .....	6-32
CRVHDR?	Curve Header Query .....	6-26	RANGE	Heater Range Cmd .....	6-32
CRVPT	Curve Data Point Cmd .....	6-26	RANGE?	Heater Range Query .....	6-32
CRVPT?	Curve Data Point Query .....	6-26	RDGST?	Input Status Query .....	6-32
CSET	Control Loop Parameter Cmd .....	6-27	REV?	Input Firmware Revision Query .....	6-33
CSET?	Control Loop Parameter Query .....	6-27	SCAL	Generate SoftCal Curve Cmd .....	6-33
DFLT	Factory Defaults Cmd .....	6-27	SETP	Control Loop Setpoint Cmd .....	6-33
DISPFLD	Displayed Field Cmd .....	6-27	SETP?	Control Loop Setpoint Query .....	6-33
DISPFLD?	Displayed Field Query .....	6-27	SRDG?	Sensor Units Reading Query .....	6-33
FILTER	Input Filter Parameter Cmd .....	6-28	TEMP?	Room-Temp Comp. Temp. Query .....	6-34
FILTER?	Input Filter Parameter Query .....	6-28	TLIMIT	Temperature Limit Command .....	6-34
HTR?	Heater Output Query .....	6-28	TLIMIT?	Temperature Limit Query .....	6-34
HTRRES	Heater Resistance Setting Cmd .....	6-28	TUNEST?	Control Loop 1 Tuning Query .....	6-34
HTRRES?	Heater Resistance Setting Query .....	6-28	ZONE	Control Loop Zone Table Cmd .....	6-34
IEEE	IEEE Interface Parameter Cmd .....	6-28	ZONE?	Control Loop Zone Table Query .....	6-35



### 6.3.1 Interface Commands (Alphabetical Listing)

**\*CLS** Clear Interface Command

**Input:** **\*CLS** [**term**]

**Remarks:** Clears the bits in the Status Byte Register and Standard Event Status Register and terminates all pending operations. Clears the interface, but *not* the controller. The related controller command is **\*RST**.

**\*ESE** Event Status Enable Register Command

**Input:** **\*ESE** <bit weighting>[**term**]

**Format:** nnn

**Remarks:** Each bit is assigned a bit weighting and represents the enable/disable mask of the corresponding event flag bit in the Standard Event Status Register. To enable an event flag bit, send the command **\*ESE** with the sum of the bit weighting for each desired bit. Refer to Section 6.1.4.2 for a list of event flags.

**Example:** To enable event flags 0, 4, and 7, send the command **\*ESE 145**[**term**]. 145 is the sum of the bit weighting for each bit.

<u>Bit</u>	<u>Bit Weighting</u>	<u>Event Name</u>
0	1	OPC
4	16	EXE
7	<u>128</u>	PON
	145	

**\*ESE?** Event Status Enable Register Query

**Input:** **\*ESE?** [**term**]

**Returned:** <bit weighting>[**term**]

**Format:** nnn Refer to Section 6.1.4.2 for a list of event flags.

**\*ESR?** Standard Event Status Register Query

**Input:** **\*ESR?** [**term**]

**Returned:** <bit weighting>

**Format:** nnn

**Remarks:** The integer returned represents the sum of the bit weighting of the event flag bits in the Standard Event Status Register. Refer to Section 6.1.4.2 for a list of event flags.

**\*IDN?** Identification Query

**Input:** **\*IDN?** [**term**]

**Returned:** <manufacturer>,<model>,<serial>,<firmware version>[**term**]

**Format:** aaaa,aaaaaaaa,aaaaaa,n.n/n.n

<manufacture>	Manufacturer ID
<model>	Instrument model number
<serial>	Serial number
<firmware version>	Instrument firmware version, main firmware/input firmware.

**Example:** **LSCI,MODEL325,1234567,1.0/1.0**

**\*OPC**      Operation Complete Command

**Input:**      **\*OPC [term]**

**Remarks:**      Generates an Operation Complete event in the Event Status Register upon completion of all pending selected device operations. Send it as the last command in a command string.

---

**\*OPC?**      Operation Complete Query

**Input:**      **\*OPC? [term]**

**Returned:**      1[term]

**Remarks:**      Places a "1" in the controller output queue upon completion of all pending selected device operations. Send as the last command in a command string. *Not* the same as **\*OPC**.

---

**\*RST**      Reset Instrument Command

**Input:**      **\*RST [term]**

**Remarks:**      Sets controller parameters to power-up settings.

---

**\*SRE**      Service Request Enable Register Command

**Input:**      **\*SRE <bit weighting>[term]**

**Format:**      nnn

**Remarks:**      Each bit has a bit weighting and represents the enable/disable mask of the corresponding status flag bit in the Status Byte Register. To enable a status flag bit, send the command **\*SRE** with the sum of the bit weighting for each desired bit. Refer to Section 6.1.4.2 for a list of status flags.

**Example:**      To enable status flags 4, 5, and 7, send the command **\*SRE 208[term]**. 208 is the sum of the bit weighting for each bit.

<u>Bit</u>	<u>Bit Weighting</u>	<u>Event Name</u>
4	16	MAV
5	64	ESB
7	<u>128</u>	OSB
	208	

---

**\*SRE?**      Service Request Enable Register Query

**Input:**      **\*SRE? [term]**

**Returned:**      <bit weighting>[term]

**Format:**      nnn      Refer to Section 6.1.4.2 for a list of status flags.

---

**\*STB?**      Status Byte Query

**Input:**      **\*STB? [term]**

**Returned:**      <bit weighting>[term]

**Format:**      nnn

**Remarks:**      Acts like a serial poll, but does not reset the register to all zeros. The integer returned represents the sum of the bit weighting of the status flag bits that are set in the Status Byte Register. Refer to Section 6.1.4.2 for a list of status flags.

---

---

**\*TST?** Self-Test Query  
**Input:** **\*TST? [term]**  
**Returned:** <status>[term]  
**Format:** n  
<status> 0 = no errors found, 1 = errors found  
**Remarks:** The Model 325 reports status based on test done at power up.

---

**\*WAI** Wait-to-Continue Command  
**Input:** **\*WAI [term]**  
**Remarks:** This command is not supported in the Model 325.

---

**CMODE** Control Loop Mode Command  
**Input:** **CMODE <loop>, <mode> [term]**  
**Format:** n,n  
<loop> Specifies which loop to configure: 1 or 2.  
<mode> Specifies the control mode. Valid entries: 1 = Manual PID, 2 = Zone, 3 = Open Loop, 4 = AutoTune PID, 5 = AutoTune PI, 6 = AutoTune P.  
**Example:** **CMODE 1,4[term]** – Control Loop 1 uses PID AutoTuning.

---

**CMODE?** Control Loop Mode Query  
**Input:** **CMODE? <loop> [term]**  
**Format:** n  
<loop> Specifies which loop to query: 1 or 2.  
**Returned:** <mode>[term]  
**Format:** n (Refer to command for description)

---

**CRDG?** Celsius Reading Query  
**Input:** **CRDG? <input> [term]**  
**Format:** a  
<input> A or B  
**Returned:** <temp value>[term]  
**Format:** ±nnnnnn  
**Remarks:** Also see the RDGST? command.

---

**CRVDEL** Curve Delete Command  
**Input:** **CRVDEL <curve> [term]**  
**Format:** nn  
<curve> Specifies a user curve to delete. Valid entries: 21–35.  
**Example:** **CRVDEL 21[term]** – Deletes User Curve 21.

---

**CRVHDR** Curve Header Command

**Input:** **CRVHDR** <curve>, <name>, <SN>, <format>, <limit value>, <coefficient>[term]

**Format:** nn,aaaaaaaaaaaaaaaa,aaaaaaaaaa,n,±nnn.nnn,n  
 <curve> Specifies which curve to configure. Valid entries: 21 – 35.  
 <name> Specifies curve name. Limited to 15 characters.  
 <SN> Specifies the curve serial number. Limited to 10 characters.  
 <format> Specifies the curve data format. Valid entries: 1 = mV/K, 2 = V/K, 3 = Ω/K, 4 = log Ω/K.  
 <limit value> Specifies the curve temperature limit in kelvin.  
 <coefficient> Specifies the curves temperature coefficient. Valid entries: 1 = negative, 2 = positive.

**Remarks:** Configures the user curve header.

**Example:** **CRVHDR 21,DT-470,00011134,2,325.0,1[term]** – Configures User Curve 21 with a name of DT-470, serial number of 00011134, data format of volts versus kelvin, upper temperature limit of 325 K. The coefficient parameter does not actually set the temperature coefficient. It is only a placeholder so that the CRVHDR command parameters match the CRVHDR? query parameters. The temperature coefficient is determined by the first two points in the curve.

**CRVHDR?** Curve Header Query

**Input:** **CRVHDR?** <curve>[term]

**Format:** nn  
 <curve> Valid entries: 1 – 36.

**Returned:** <name>, <SN>, <format>, <limit value>, <coefficient>[term]

**Format:** aaaaaaaaaaaaaaaaa,aaaaaaaaaa,n,±nnn.nnn,n (Refer to command for description)

**CRVPT** Curve Data Point Command

**Input:** **CRVPT** <curve>, <index>, <units value>, <temp value>[term]

**Format:** nn,nnn,±nnnnnnn,±nnnnnnn  
 <curve> Specifies which curve to configure. Valid entries: 21 – 35.  
 <index> Specifies the points index in the curve. Valid entries: 1 – 200.  
 <units value> Specifies sensor units for this point to 6 digits.  
 <temp value> Specifies the corresponding temperature in kelvin for this point to 6 digits.

**Remarks:** Configures a user curve data point.

**Example:** **CRVPT 21,2,0.10191,470.000,N[term]** – Sets User Curve 21 second data point to 0.10191 sensor units and 470.000 K.

**CRVPT?** Curve Data Point Query

**Input:** **CRVPT?** <curve>, <index>[term]

**Format:** nn,nnn  
 <curve> Specifies which curve to query: 1 – 35.  
 <index> Specifies the points index in the curve: 1 – 200.

**Returned:** <units value>, <temp value>[term]

**Format:** ±nnnnnnn,±nnnnnnn (Refer to command for description)

**Remarks:** Returns a standard or user curve data point.

---

**CSET** Control Loop Parameter Command

**Input:** **CSET** <loop>, <input>, <units>, <powerup enable>, <current/power>[term]

**Format:** n,a,n,n,n

<loop> Specifies which loop to configure: 1 or 2.

<input> Specifies which input to control from: A or B.

<units> Specifies setpoint units. Valid entries: 1 = kelvin, 2 = Celsius, 3 = sensor units.

<powerup enable> Specifies whether the control loop is on or off after power-up, where 0 = powerup enable off and 1 = powerup enable on.

<current/power> Specifies whether the heater output displays in current or power. Valid entries: 1 = current or 2 = power.

**Example:** **CSET 1,A,1,1[term]** – Control Loop 1 controls off of Input A with setpoint in kelvin.

---

**CSET?** Control Loop Parameter Query

**Input:** **CSET?** <loop>[term]

**Format:** n

<loop> Specifies which loop to query: 1 or 2.

**Returned:** <input>, <units>, <powerup enable>, <current/power>[term]

**Format:** a,n,n,n (Refer to command for description)

---

**DFLT** Factory Defaults Command

**Input:** **DFLT 99[term]**

**Remarks:** Sets all configuration values to factory defaults and resets the instrument. The "99" is included to prevent accidentally setting the unit to defaults.

---

**DISPFLD** Displayed Field Command

**Input:** **DISPFLD** <field>, <item>, <source>[term]

**Format:** n,n,n

<field> Specifies field to configure: 1–4.

<item> Specifies item to display in the field: 0 = Off, 1 = Input A, 2 = Input B, 3 = Setpoint, 4 = Heater Output.

<source> If Item is 1 or 2, specifies input data to display. Valid entries: 1 = kelvin, 2 = Celsius, 3 = sensor units

**Example:** **DISPFLD 2,1,1[term]** – Displays kelvin reading for Input A in display field 2.

---

**DISPFLD?** Displayed Field Query

**Input:** **DISPFLD?** <field>[term]

**Format:** n

<field> Specifies field to query: 1–4.

**Returned:** <item>, <source>[term]

**Format:** n,n (Refer to command for description)

---

---

**FILTER** Input Filter Parameter Command

**Input:** **FILTER** <input>, <off/on>, <points>, <window>[term]

**Format:** a,n,nn,nn

<input> Specifies input to configure: A or B.

<off/on> Specifies whether the filter function is 0 = Off or 1 = On.

<points> Specifies how many data points the filtering function uses. Valid range = 2 to 64.

<window> Specifies what percent of full scale reading limits the filtering function. Reading changes greater than this percentage reset the filter. Valid range = 1 to 10%.

**Example:** **FILTER B,1,10,2[term]** – Filter input B data through 10 readings with 2% of full scale window.

---

**FILTER?** Input Filter Parameter Query

**Input:** **FILTER?** <input>[term]

**Format:** a

<input> Specifies input to query: A or B.

**Returned:** <off/on >, <points>, <window>[term]

**Format:** n,nn,nn (Refer to command for description)

---

**HTR?** Heater Output Query

**Input:** **HTR?** <loop>[term]

**Returned:** <heater value>[term]

**Format:** +nnn.n

<heater value> Loop 1 or Loop 2 heater output in percent (%) of current or power, depending on setting. (Refer to CSET command).

---

**HTRRES** Heater Resistance Setting command

**Input:** **HTRRES** <loop>,<setting>[term]

**Format:** n,n

<loop> Specifies loop to configure: 1 or 2.

<setting> Heater Resistance Setting: 1 = 25  $\Omega$ , 2 = 50  $\Omega$ ..

---

**HTRRES?** Heater Resistance Setting Query

**Input:** **HTRRES?** <loop>[term]

**Returned:** <setting>[term]

**Format:** n (Refer to command for description)

---

**IEEE** IEEE-488 Interface Parameter Command

**Input:** **IEEE** <terminator>, <EOI enable>, <address>[term]

**Format:** n,n,nn

<terminator> Specifies the terminator. Valid entries: 0 = <CR><LF>, 1 = <LF><CR>, 2 = <LF>, 3 = no terminator (must have EOI enabled).

<EOI enable> Sets EOI mode: 0 = enabled, 1 = disabled.

<address> Specifies the IEEE address: 1 – 30. (Address 0 and 31 are reserved.)

**Example:** **IEEE 0,0,4[term]** – After receipt of the current terminator, the instrument uses EOI mode, uses <CR><LF> as the new terminator, and responds to address 4.

---

**IEEE?** IEEE-488 Interface Parameter Query  
**Input:** **IEEE?** [**term**]  
**Returned:** <terminator>, <EOI enable>, <address>[**term**]  
**Format:** n,n,nn (Refer to command for description)

---

**INCRV** Input Curve Number Command  
**Input:** **INCRV** <**input**>, <**curve number**>[**term**]  
**Format:** a,nn  
 <input> Specifies which input to configure: A or B.  
 <curve number> Specifies which curve the input uses. If specified curve parameters do not match the input, the curve number defaults to 0. Valid entries:  
 0 = none, 1–20 = standard curves, 21–35 = user curves.  
**Remarks:** Specifies the curve an input uses for temperature conversion.  
**Example:** **INCRV A,23**[**term**] – Input A uses User Curve 23 for temperature conversion.

---

**INCRV?** Input Curve Number Query  
**Input:** **INCRV?** <**input**>[**term**]  
**Format:** a  
 <input> Specifies which input to query: A or B.  
**Returned:** <curve number>[**term**]  
**Format:** nn (Refer to command for description)

---

**INTYPE** Input Type Parameter Command  
**Input:** **INTYPE** <**input**>, <**sensor type**>, <**compensation**>[**term**]  
**Format:** a,n,n  
 <input> Specifies input to configure: A or B.  
 <sensor type> Specifies input sensor type. Valid entries:  
 0 = Silicon diode                      5 = NTC RTD  
 1 = GaAlAs diode                      6 = Thermocouple 25 mV  
 2 = 100 Ω platinum/250              7 = Thermocouple 50 mV  
 3 = 100 Ω platinum/500              8 = 2.5 V, 1 mA  
 4 = 1000 Ω platinum                  9 = 7.5 V, 1 mA  
 <compensation> Specifies input compensation where 0 = off and 1 = on. Reversal for thermal EMF compensation if input is resistive, room temperature compensation if input is thermocouple. Always 0 if input is a diode.  
**Example:** **INTYPE A,0,0**[**term**] – Sets Input A sensor type to silicon diode.

---

**INTYPE?** Input Type Parameter Query  
**Input:** **INTYPE?** <**input**>[**term**]  
**Format:** a  
 <input> Specifies input to query: A or B.  
**Returned:** <sensor type>, <compensation>[**term**]  
**Format:** n,n (Refer to command for description)

---

---

**KEYST?** Last Key Press Query  
**Input:** **KEYST?** [**term**]  
**Returned:** <code>[term]  
**Format:** nn  
**Remarks:** Returns a number descriptor of the last key pressed since the last KEYST?. Returns "21" after initial power-up. Returns "00" if no key pressed since last query.

---

**KRDG?** Kelvin Reading Query  
**Input:** **KRDG?** <input>[**term**]  
**Format:** a  
<input> Specifies which input to query: A or B.  
**Returned:** <kelvin value>[term]  
**Format:** ±nnnnnn  
**Remarks:** Also see the RDGST? command.

---

**LOCK** Front Panel Keyboard Lock Command  
**Input:** **LOCK** <state>, <code>[**term**]  
**Format:** n,nnn  
<state> 0 = Unlocked, 1 = Locked  
<code> Specifies lock-out code. Valid entries are 000–999.  
**Remarks:** Locks out all front panel entries.  
**Example:** **LOCK 1,123**[**term**] – Enables keypad lock and sets the code to 123.

---

**LOCK?** Front Panel Keyboard Lock Query  
**Input:** **LOCK?** [**term**]  
**Returned:** <state>, <code>[term]  
**Format:** n,nnn (Refer to command for description)

---

**MODE** Remote Interface Mode Command  
**Input:** **MODE** <mode>[**term**]  
**Format:** n  
<mode> 0 = local, 1 = remote, 2 = remote with local lockout.  
**Example:** **MODE 2**[**term**] – Places the Model 325 into remote mode with local lockout.

---

**MODE?** Remote Interface Mode Query  
**Input:** **MODE?** [**term**]  
**Returned:** <mode>[term]  
**Format:** n (Refer to command for description)

---



**MOUT** Control Loop Manual Heater Power (MHP) Output Command**Input:** **MOUT** <loop>, <value>[term]**Format:** n,±nnnnnn[term]  
<loop> Specifies loop to configure: 1 or 2.  
<value> Specifies value for manual output.**Example:** **MOUT 1,22.45[term]** – Control Loop 1 manual heater output is 22.45%.**MOUT?** Control Loop Manual Heater Power (MHP) Output Query**Input:** **MOUT?** <loop>[term]**Format:** n  
<loop> Specifies which loop to query: 1 or 2.**Returned:** <value>**Format:** ±nnnnnn[term] (Refer to command for description)**PID** Control Loop PID Values Command**Input:** **PID** <loop>, <P value>, <I value>, <D value>[term]**Format:** n,±nnnnnn,±nnnnnn,±nnnnnn  
<loop> Specifies loop to configure: 1 or 2.  
<P value> The value for control loop Proportional (gain): 0.1 to 1000.  
<I value> The value for control loop Integral (reset): 0.1 to 1000.  
<D value> The value for control loop Derivative (rate): 0 to 200.**Remarks:** Setting resolution is less than 6 digits indicated.**Example:** **PID 1,10,50[term]** – Control Loop 1 P is 10 and I is 50.**PID?** Control Loop PID Values Query**Input:** **PID?** <loop>[term]**Format:** n  
<loop> Specifies which loop to query: 1 or 2.**Returned:** <P value>, <I value>, <D value>[term]**Format:** ±nnnnnn,±nnnnnn,±nnnnnn (Refer to command for description)**RAMP** Control Setpoint Ramp Parameter Command**Input:** **RAMP** <loop>, <off/on>, <rate value>[term]**Format:** n,n,±nnnnn  
<loop> Specifies which loop to configure: 1 or 2.  
<off/on> Specifies whether ramping is 0 = Off or 1 = On.  
<rate value> Specifies setpoint ramp rate in kelvin per minute from 0.0 to 100. The rate is always positive, but will respond to ramps up or down. A ramp setting of 0.0 will cause the instrument to respond as if the ramp is off, i.e. setpoint changes will be immediate.**Example:** **RAMP 1,1,10.5[term]** – When Control Loop 1 setpoint is changed, ramp the current setpoint to the target setpoint at 10.5 K/minute.

---

**RAMP?** Control Setpoint Ramp Parameter Query

**Input:** **RAMP?** <loop>

**Format:** n  
<loop> Specifies which loop to query: 1 or 2.

**Returned:** <off/on>, <rate value>[term]

**Format:** n,±nnnnn (Refer to command for description)

---

**RAMPST?** Control Setpoint Ramp Status Query

**Input:** **RAMPST?** <loop>[term]

**Format:** n  
<loop> Specifies which loop to query: 1 or 2.

**Returned:** <ramp status>[term]

**Format:** n  
<ramp status> 0 = Not ramping, 1 = Setpoint is ramping.

---

**RANGE** Heater Range Command

**Input:** **RANGE** <loop>,<range>[term]

**Format:** n,n  
<loop> Specifies loop to configure: 1 or 2.  
<range> For loop 1: 0 = Off, 1 = Low (2.5 W), 2 = High (25 W)  
For loop 2: 0 = Off, 1 = On

---

**RANGE?** Heater Range Query

**Input:** **RANGE?** <loop>[term]

**Format:** n  
<loop> Specifies which loop to query: 1 or 2.

**Returned:** <range>[term]

**Format:** n (Refer to command for description)

---

**RDGST?** Input Reading Status Query

**Input:** **RDGST?** <input>[term]

**Format:** a  
<input> Specifies which input to query: A or B.

**Returned:** <status bit weighting>[term]

**Format:** nnn

**Remarks:** The integer returned represents the sum of the bit weighting of the input status flag bits. A “000” response indicates a valid reading is present.

<u>Bit</u>	<u>Bit Weighting</u>	<u>Status Indicator</u>
0	1	invalid reading
4	16	temp underrange
5	32	temp overrange
6	64	sensor units zero
7	128	sensor units overrange

---

---

<b>SCAL</b>	Generate SoftCal Curve Command
<b>Input:</b>	<b>SCAL &lt;std&gt;, &lt;dest&gt;, &lt;SN&gt;, &lt;T1 value&gt;, &lt;U1 value&gt;, &lt;T2 value&gt;, &lt;U2 value&gt;, &lt;T3 value&gt;, &lt;U3 value&gt;[term]</b>
<b>Format:</b>	n,nn,aaaaaaaaa,±nnnnn,±nnnnn,±nnnnn,±nnnnn,±nnnnn,±nnnnn <std> Specifies the standard curve to generate a SoftCal from. Valid entries: 1, 6, 7. <dest> Specifies the user curve to store the SoftCal curve. Valid entries: 21 – 35. <SN> Specifies the curve serial number. Limited to 10 characters. <T1 value> Specifies first temperature point. <U1 value> Specifies first sensor units point. <T2 value> Specifies second temperature point. <U2 value> Specifies second sensor units point. <T3 value> Specifies third temperature point. <U3 value> Specifies third sensor units point.
<b>Remarks:</b>	Generates a SoftCal curve. Refer to Section 5.3.
<b>Example:</b>	<b>SCAL 1,21,1234567890,4.2,1.6260,77.32,1.0205,300.0,0.5189[term]</b> – Generates a three-point SoftCal curve from standard curve 1 and saves it in user curve 21.

---

<b>SETP</b>	Control Setpoint Command
<b>Input:</b>	<b>SETP &lt;loop&gt;, &lt;value&gt;[term]</b>
<b>Format:</b>	n,±nnnnnn <loop> Specifies which loop to configure. <value> The value for the setpoint (in whatever units the setpoint is using).
<b>Example:</b>	<b>SETP 1,122.5[term]</b> – Control Loop 1 setpoint is now 122.5 (based on its units).

---

<b>SETP?</b>	Control Setpoint Query
<b>Input:</b>	<b>SETP? &lt;loop&gt;[term]</b>
<b>Format:</b>	n <loop> Specifies which loop to query: 1 or 2.
<b>Returned:</b>	<value>[term]
<b>Format:</b>	±nnnnnn

---

<b>SRDG?</b>	Sensor Units Input Reading Query
<b>Input:</b>	<b>SRDG? &lt;input&gt;[term]</b>
<b>Format:</b>	a <input> Specifies which input to query: A or B.
<b>Returned:</b>	<sensor units value>[term]
<b>Format:</b>	±nnnnnn
<b>Remarks:</b>	Also see the RDGST? command.

---

---

**TEMP?** Thermocouple Junction Temperature Query

**Input:** **TEMP?**

**Returned:** <junction temperature>[term]

**Format:** ±nnnnnnn

**Remarks:** Temperature is in kelvin. This query returns the temperature of the ceramic thermocouple block used in the room temperature compensation calculation.

---

**TLIMIT** Temperature Limit Command (Firmware Version 1.5 and Later)

**Input:** **TLIMIT <input>, <limit>[term]**

**Format:** a,+nnnn

<input> Specifies which input to configure: A or B.

<limit value> The temperature limit in Kelvin for which to shut down all control outputs when exceeded. A temperature limit of zero turns the temperature limit feature off for the given sensor input.

**Remarks:** A temperature limit setting of 0 K turns the temperature limit feature off.

**Example:** **TLIMIT B,450[term]** – If the temperature of the sensor on Input B exceeds 450 K, all control outputs will be turned off.

---

**TLIMIT?** Temperature Limit Query (Firmware Version 1.5 and Later)

**Input:** **TLIMIT? <input>[term]**

**Format:** a

<input> Specifies which input to query: A or B.

**Returned:** <limit value>[term]

**Format:** +nnnn

---

**TUNEST?** Control Tuning Status Query

**Input:** **TUNEST?**

**Returned:** <tuning status>[term]

**Format:** n 0 = no active tuning, 1 = active tuning.

**Remarks:** The tuning status will return active (1) if either Loop 1 or Loop 2 is actively tuning.

---

**ZONE** Control Loop Zone Table Parameter Command

**Input:** **ZONE <loop>, <zone>, <setpoint limit>, <P value>, <I value>, <D value>, <mout value>, <range>[term]**

**Format:** n,nn,±nnnnnn,±nnnnnn,±nnnnnn,±nnnnnn,±nnnnnn,n[term]

<loop> Specifies which loop to configure: 1 or 2.

<zone> Specifies which zone in the table to configure. Valid entries are: 1–10.

<setpoint limit> Specifies the setpoint limit of this zone.

<P value> Specifies the P for this zone: 0.1 to 1000.

<I value> Specifies the I for this zone: 0.1 to 1000.

<D value> Specifies the D for this zone: 0 to 200%.

<mout value> Specifies the manual output for this zone: 0 to 100%.

<range> Specifies the heater range for this zone if <loop> = 1. Valid entries: 0–2. If <loop> = 2, then <range> = 1 and cannot be changed.

**Remarks:** Configures the control loop zone parameters. Refer to Section 2.9.

**Example:** **ZONE 1,1,25.0,10,20,0,0,2[term]** – Control Loop 1 zone 1 is valid to 25.0 K with P = 10, I = 20, D = 0, and a heater range of 2.

---

**ZONE?** Control Loop Zone Table Parameter Query

**Input:** ZONE? <loop>, <zone>[term]

**Format:** n,nn

<loop> Specifies which loop to query: 1 or 2.

<zone> Specifies which zone in the table to query. Valid entries: 1–10.

**Returned:** <top value>, <P value>, <I value>, <D value>, <mout value>, <range>[term]

**Format:** ±nnnnnn,±nnnnnn,±nnnnnn,±nnnnnn,±nnnnnn,n (Refer to command for description)

---

This Page Intentionally Left Blank

# CHAPTER 7

## OPTIONS AND ACCESSORIES

### 7.0 GENERAL

This chapter provides information on the models, options, and accessories available for the Model 325 temperature controller.

### 7.1 MODELS

The list of Model 325 model numbers is provided as follows.

Model	Description of Models
325	<p><b>Standard Temperature Controller.</b> Includes all features. Model numbers as follows:</p> <p><b>325</b> ..... Two diode/resistor inputs</p> <p><b>325-T1</b> ..... One diode/resistor, one thermocouple input</p> <p><b>325-T2</b> ..... Two thermocouple inputs</p>

**Power Configurations.** The instrument is configured at the factory for customer-selected power as follows:

<b>VAC-100</b>	Instrument configured for 100 VAC with U.S. power cord
<b>VAC-120</b>	Instrument configured for 120 VAC with U.S. power cord
<b>VAC-220</b>	Instrument configured for 220 VAC with universal European line cord
<b>VAC-240</b>	Instrument configured for 240 VAC with universal European line cord
<b>VAC-120-ALL</b>	Instrument configured for 120 VAC with U.S. power cord and universal European line cord and fuses for 220/240 VAC setting

### 7.2 OPTIONS

The list of Model 325 options is provided as follows.

Model	Description of Options
8000	<p><b>CalCurve™ on CD or E-Mail.</b> The Model 8000 CalCurve is offered on CD or via e-mail free of charge at time of order to any customer who orders a calibrated sensor. The Model 8000 consists of calibration breakpoint interpolation data stored in ASCII format. Also included is a PC executable program to load the data into a Lake Shore Instrument via IEEE-488 or RS-232 interface. Once loaded, the instrument uses the data to calculate and display temperature. The following information is included: raw data, coefficients, interpolation table, instrument breakpoints, LSCurves.exe DOS-based program, and Readme.txt describing the file formats.</p>
8001-325	<p><b>CalCurve™, Factory Installed.</b> Provides users with a convenient method of storing sensor calibrations within Lake Shore Instruments. Calibration data (breakpoint interpolation table) for a specific sensor is stored into a nonvolatile memory.</p>

### 7.3 ACCESSORIES

Accessories are devices that perform a secondary duty as an aid or refinement to the primary unit.

Refer to the Lake Shore Temperature Measurement and Control Catalog for details. A list of accessories available for the Model 325 is as follows:

Model	Description of Accessories
106-009*	<b>Heater Output Connector.</b> Dual banana jack for heater output.
G-106-233*	<b>Sensor Input Mating Connector.</b> 6-pin DIN plug for diode/resistor input; 2 included.
106-735*	<b>Terminal Block Mating Connector.</b> 2-pin terminal block for Loop 2.
G-112-325	<b>Model 325 Sensor/Heater Cable Assembly — 10 Feet.</b> Cable assembly for 2 diode/resistor sensors and Loop 1 heater. Approximately 3 m (10 ft) long. See Figure 7-1.
G-112-326	<b>Model 325 Sensor/Heater Cable Assembly — 20 Feet.</b> Cable assembly for 2 diode/resistor sensors and Loop 1 heater. Approximately 6 m (20 ft) long. See Figure 7-1.
115-006*	<b>Detachable 120 VAC Line Cord.</b>
3003	<b>Heater Output Conditioner.</b> The heater output conditioner is a passive filter that further reduces the already low heater output noise of the Model 325. Refer to Section 7.4 and see Figure 7-2.
6201	<b>IEEE-488 Cable.</b> 1 m (3 ft) long IEEE-488 (GPIB) computer interface cable assembly.
CAL-325-CERT	<b>Instrument recalibration with certificate.</b>
CAL-325-DATA	<b>Instrument recalibration with certificate and data.</b>
ES-2-20	<b>Stycast<sup>®</sup> Epoxy 2850-FT, Catalyst 9 (20 packets, 2 g each).</b> Stycast is a common, highly versatile, nonconductive epoxy resin system for cryogenic use. The primary use for Stycast is for vacuum feedthroughs or permanent thermal anchors. Stycast is an alternative to Apiezon N Grease when permanent sensor mountings are desired.
ID-10-XX	<b>Indium Solder Disks (Quantity 10).</b> Indium is a semi-precious non-ferrous metal, softer than lead, and extremely malleable and ductile. It stays soft and workable down to cryogenic temperatures. Indium can be used to create solder “bumps” for microelectronic chip attachments and also as gaskets for pressure and vacuum sealing purposes. <b>ID-10-31</b> Indium Disks are 0.312 diameter × 0.005 in. <b>ID-10-56</b> Indium Disks are 0.562 diameter × 0.005 in.
IF-5	<b>Indium Foil Sheets (Quantity 5).</b> When used as a washer between DT-470-CU silicon diode or other temperature sensors and refrigerator cold stages, indium foil increases the thermal contact area and prevents the sensor from detaching due to vibration. It also may be used as a sealing gasket for covers, flanges, and windows in cryogenic applications. Each sheet is 0.005 × 2 × 2 in.
GAH-25	<b>Apiezon<sup>®</sup> “H” Grease, 25 g Tube.</b> It is designed for general purposes where operating temperatures necessitate the use of a relatively high melting point grease. Melting point is ≈523 K (250 °C). Can be removed using Xylene with an isopropyl alcohol rinse.
GAN-25	<b>Apiezon<sup>®</sup> “N” Grease, 25 g Tube.</b> General purpose grease well-suited for cryogenic use because of its low viscosity. It is often used as a means of thermally anchoring cryogenic sensors as well as lubricating joints and o-rings. Contains high molecular weight polymeric hydrocarbon additive that gives it a tenacious, rubbery consistency allowing the grease to form a cushion between mating surfaces. Melting point is ≈316 K (43 °C). Can be removed using Xylene with an isopropyl alcohol rinse.

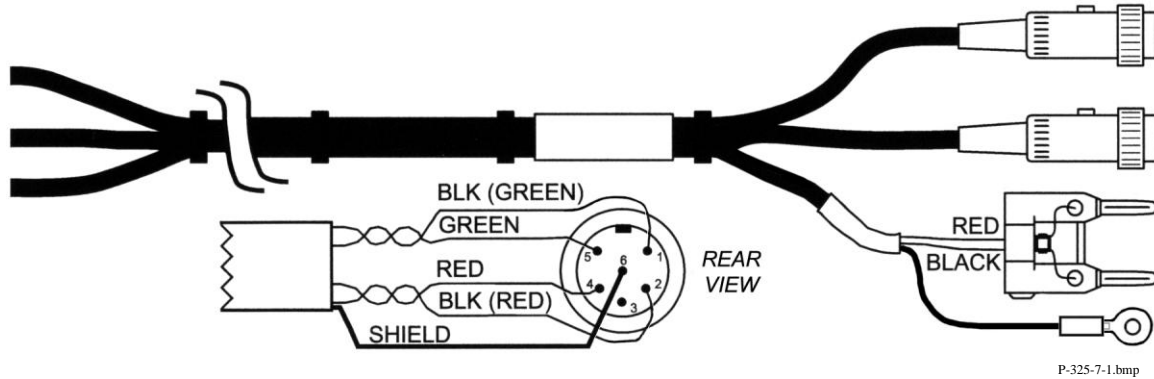
\* Accessories included with a new Model 325.



**Accessories (Continued)**

Model	Description of Accessories (Continued)
<b>HTR-25</b>	<b>25 Ω Cartridge Heater.</b> The heater features precision-wound nickel-chromium resistance wire, magnesium oxide insulation, two solid pins, non-magnetic package, and has UL and CSA component recognition. The heater is 25 Ω, 6.35 mm (0.25 in) diameter by 25.4 mm (1 in) long. The 25 Ω rating is in dead air. With proper heat sinking, the cartridge heater can handle many times this dead air power rating.
<b>HTR-50</b>	<b>50 Ω Cartridge Heater.</b> The heater features precision-wound nickel-chromium resistance wire, magnesium oxide insulation, two solid pins, non-magnetic package, and has UL and CSA component recognition. The heater is 50 Ω, 6.35 mm (0.25 in) diameter by 25.4 mm (1 in) long. The 50 Ω rating is in dead air. With proper heat sinking, the cartridge heater can handle many times this dead air power rating.
<b>MAN-325*</b>	<b>Model 325 Temperature Controller User's Manual.</b>
<b>RM-1/2</b>	<b>Half-Rack Mounting Kit for One Model 325 Temperature Controller.</b> Half-length mounting panel and mounting ears to attach one Model 325 to a 483 mm (19 in) rack mount space. See Figure 7-3.
<b>RM-2</b>	<b>Dual Mounting Shelf for Two Model 325 Temperature Controllers.</b> Mounting shelf to attach any two 5.25 in tall half-rack instruments side-by-side on a 483 mm (19 in) rack mount shelf. See Figure 7-4.
<b>VGE-7031</b>	<b>IMI-7031 Varnish (formerly GE 7031 Varnish) (1 pint can).</b> IMI-7031 Insulating Varnish and Adhesive possesses electrical and bonding properties which, when combined with its chemical resistance and good saturating properties, make it an excellent material for cryogenic temperatures. As an adhesive, IMI-7031 bonds a variety of materials, has fast tack time, and may be air dried or baked. It is also an electrically insulating adhesive at cryogenic temperatures and is often used as a calorimeter cement. When soaked into cigarette paper, it makes a good, high thermal conductivity, low electrical conductivity heat sinking layer. Maximum operating temperature: 423 K (150 °C).
<b>Wire</b>	<b>Lake Shore Cryogenic Wire.</b> Lake Shore sells the following types of cryogenic wire: DT = Duo-Twist™, MN = Single Strand, MW = Manganin, NC = Nichrome Heater, ND = Heavy Duty, QL = Quad-Lead™, and QT = Quad-Twist™. <b>Lake Shore Coaxial Cable.</b> Lake Shore sells the following types of coaxial cable: CC = Ultra Miniature Coaxial Cable, SR = Semi-Rigid Coaxial Cable, CRYC = CryoCable™.

\* Accessories included with a new Model 325.



**Figure 7-1. Model 325 Sensor and Heater Cable Assembly**  
 10 ft: P/N G-112-325, 20 ft: P/N G-112-326

#### 7.4 MODEL 3003 HEATER OUTPUT CONDITIONER

The Lake Shore Model 3003 heater output conditioner is a passive filter that reduces the already low noise present in the heater output of the Model 325. The Model 3003 connects between the heater output terminals on the rear panel of a controller and a resistive heater. See Figure 7-2.

Specifications are as follows:

Max Current: .....2 A

Max Voltage: .....60 V

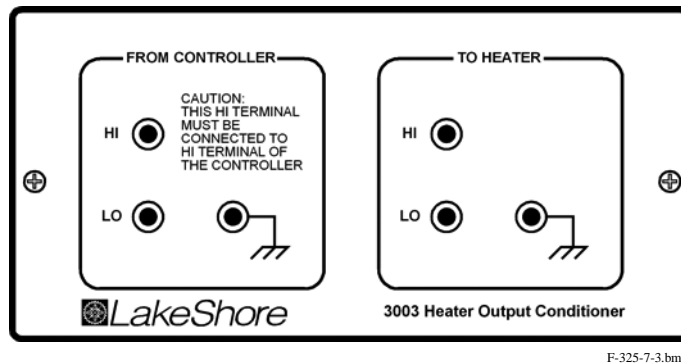
Attenuation:.....50 or 60 Hz (line frequency): 20 dB  
 100 Hz and above (line frequency harmonics): 40 dB

Enclosure Size:.....144 mm wide × 72 mm long × 165 mm deep (5.7 × 2.8 × 6.5 in)

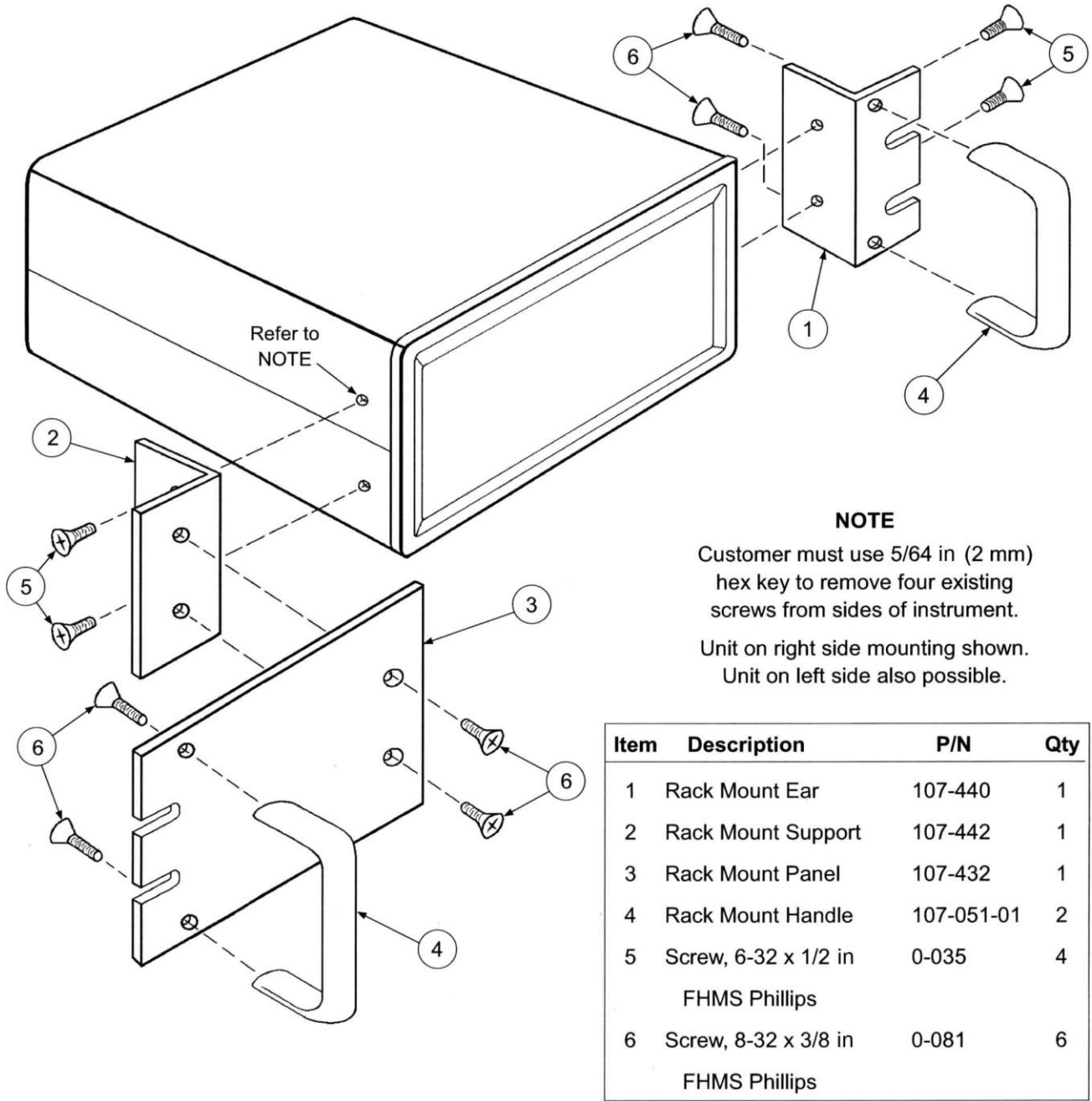
Weight:.....1.6 kg (3.5 lb)

The Model 3003 is a passive filter and requires no external power supply. The **High** and **Low** terminals on the controller must be connected to the **High** and **Low** terminals marked *From Controller* on the Model 3003. The binding posts or a dual banana plug can be used to connect to the Model 3003. Precautions must be taken to ensure the High and Low terminals are not reversed. A diode in the Model 3003 shorts the heater output if the polarity of the terminals is reversed.

The **High** and **Low** terminals marked *To Heater* on the Model 3003 should be attached to a resistive heater used for temperature control. The binding posts or a dual banana plug can be used to connect to the Model 3003. The ground terminals on the Model 3003 continue the shield if the heater cable is shielded.

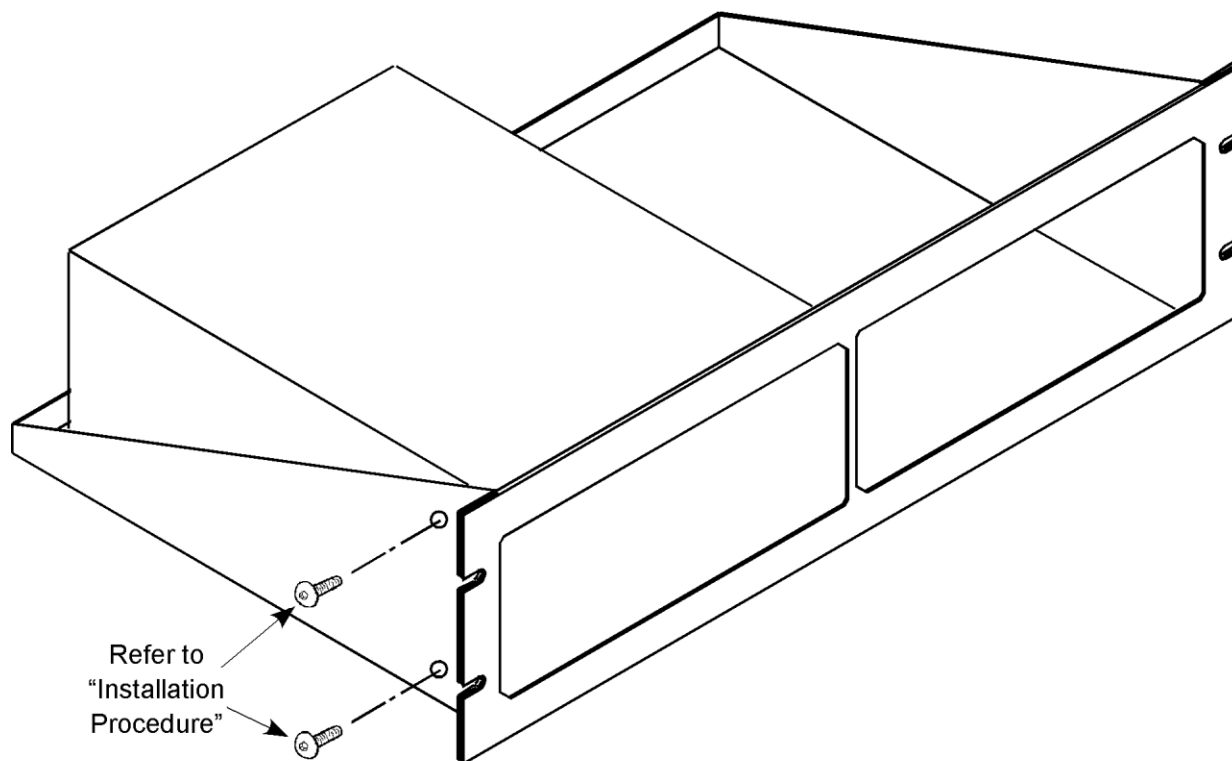


**Figure 7-2. Model 3003 Heater Output Conditioner**



P-325-7-4.jpg

Figure 7-3. Model RM-1/2 Rack-Mount Kit



#### Installation Procedure

1. Use 5/64 in (2 mm) hex key to remove two 6-32 x 1/4 black button head screws from side of instrument.
2. Place Instrument on shelf.
3. Use 5/64 in (2 mm) hex key to reinstall two 6-32 x 1/4 black button head screws through side of rack into corresponding holes in the side of the instrument.

C-325-7-5.bmp

**Figure 7-4. Model RM-2 Dual Rack-Mount Shelf**

## CHAPTER 8

### SERVICE

#### 8.0 GENERAL

This chapter provides basic service information for the Model 325 temperature controller. Customer service of the product is limited to the information presented in this chapter. Factory trained service personnel should be consulted if the instrument requires repair.

#### 8.1 CONTACTING LAKE SHORE CRYOTRONICS

If a Lake Shore product was purchased through a dealer or representative, please use that resource for prompt sales or service information. When contacting Lake Shore directly, please specify the name of a department if do not know the name of an individual. Questions regarding product applications, price, availability and shipments should be directed to sales. Questions regarding instrument calibration or repair should be directed to instrument service. **Do not return a product to Lake Shore without an RA number.** Refer to Section 8.2. Contact information may change periodically but current contact information can always be found on the Lake Shore website: [www.lakeshore.com](http://www.lakeshore.com).

Mailing Address:	Lake Shore Cryotronics, Inc. Instrument Service Department 575 McCorkle Blvd. Westerville, OH USA 43082-8888	
E-mail Address:	<a href="mailto:sales@lakeshore.com">sales@lakeshore.com</a> <a href="mailto:service@lakeshore.com">service@lakeshore.com</a>	Sales Instrument Service
Telephone:	614-891-2244 614-891-2243 ext. 131	Sales Instrument Service
Fax:	614-818-1600 614-818-1609	Sales Instrument Service
Web Service Request:	<a href="http://www.lakeshore.com/sup/serf.html">http://www.lakeshore.com/sup/serf.html</a>	Instrument Service

When contacting Lake Shore please provide your name and complete contact information including e-mail address if possible. It is often helpful to include the instrument model number and serial number (located on the rear panel of the instrument) as well as the firmware revision information as described in Section 4.18.

#### 8.2 RETURNING PRODUCTS TO LAKE SHORE

If it is necessary to return the Model 325 or accessories for recalibration, repair or replacement, a Return Authorization (RA) number must be obtained from a factory representative or from the Lake Shore web site.

**NOTE:** Please do not return a product to Lake Shore without an RA number.

The following information must be provided to Lake Shore in order to obtain an RA number.

1. Instrument model and serial number.
2. User name, company, address, phone number, and e-mail address.
3. Malfunction symptoms.
4. Description of the system in which the product is used.

If possible, the original packing material should be retained for reshipment. If not available, a minimum of three inches of shock adsorbent packing material should be placed snugly on all sides of the instrument in a sturdy corrugated cardboard box. The RA number should be included in the mailing label or written prominently on the outside of the box. A copy of the customer contact information and RA number should be included inside the box. Consult Lake Shore with questions regarding shipping and packing instructions.

### 8.3 FUSE DRAWER

The fuse drawer supplied with the Model 325 holds the instrument line fuses and line voltage selection module. The drawer holds two 5 × 20 mm time delay fuses. It requires two good fuses of the same rating to operate safely. Refer to Section 8.5 for details.

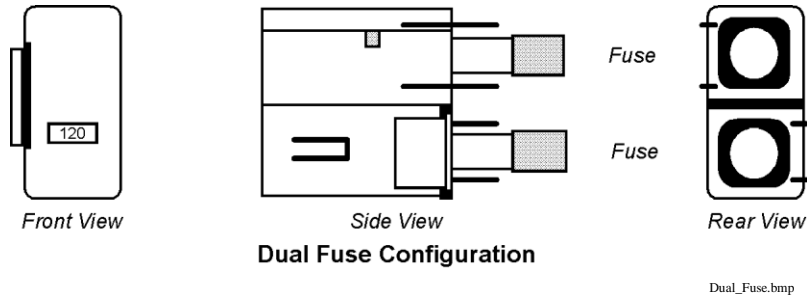


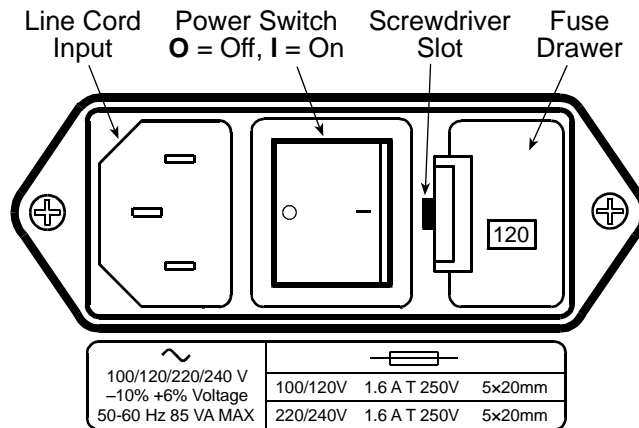
Figure 8-1. Fuse Drawer

### 8.4 LINE VOLTAGE SELECTION

Use the following procedure to change the instrument line voltage selector. Verify the fuse value whenever line voltage is changed.

**WARNING:** To avoid potentially lethal shocks, turn off controller and disconnect it from AC power before performing these procedures.

1. Identify the line input assembly on the instrument rear panel. See Figure 8-2.
2. Turn the line power switch OFF (O).
3. Remove the instrument power cord.
4. With a small screwdriver, release the drawer holding the line voltage selector and fuse.
5. Slide out the removable plastic fuse holder from the drawer.
6. Rotate the fuse holder until the proper voltage indicator shows through the window.
7. Verify the proper fuse value.
8. Re-assemble the line input assembly in the reverse order.
9. Verify the voltage indicator in the window of the line input assembly.
10. Connect the instrument power cord.
11. Turn the line power switch On (I).



F-325-8-2.wmf

Figure 8-2. Power Fuse Access

## 8.5 FUSE REPLACEMENT

Use the following procedure to remove and replace a line fuse.

**WARNING:** To avoid potentially lethal shocks, turn off controller and disconnect it from AC power before performing these procedures.

**CAUTION:** For continued protection against fire hazard, replace only with the same fuse type and rating specified for the line for the line voltage selected.

**NOTE:** Test fuse with an ohmmeter. Do not rely on visual inspection of fuse.

1. Locate line input assembly on the instrument rear panel. See Figure 8-2.
2. Turn power switch Off (O).
3. Remove instrument power cord.
4. With a small screwdriver, release the drawer holding the line voltage selector and fuse.
5. Remove existing fuse(s). Replace with proper Slow-Blow (time-delay) fuse ratings as follows:

100/120 V	1.6 A T 250 V	5×20 mm
220/240 V	1.6 A T 250 V	5×20 mm

6. Re-assemble line input assembly in reverse order.
7. Verify voltage indicator in the line input assembly window.
8. Connect instrument power cord.
9. Turn power switch On (I).

## 8.6 ELECTROSTATIC DISCHARGE

Electrostatic Discharge (ESD) may damage electronic parts, assemblies, and equipment. ESD is a transfer of electrostatic charge between bodies at different electrostatic potentials caused by direct contact or induced by an electrostatic field. The low-energy source that most commonly destroys Electrostatic Discharge Sensitive (ESDS) devices is the human body, which generates and retains static electricity. Simply walking across a carpet in low humidity may generate up to 35,000 V of static electricity.

Current technology trends toward greater complexity, increased packaging density, and thinner dielectrics between active elements, which results in electronic devices with even more ESD sensitivity. Some electronic parts are more ESDS than others. ESD levels of only a few hundred volts may damage electronic components such as semiconductors, thick and thin film resistors, and piezoelectric crystals during testing, handling, repair, or assembly. Discharge voltages below 4000 V cannot be seen, felt, or heard.

### 8.6.1 Identification of Electrostatic Discharge Sensitive Components

The following are various industry symbols used to label components as ESDS.



### 8.6.2 Handling Electrostatic Discharge Sensitive Components

Observe all precautions necessary to prevent damage to ESDS components before attempting installation. Bring the device and everything that contacts it to ground potential by providing a conductive surface and discharge paths. As a minimum, observe these precautions:

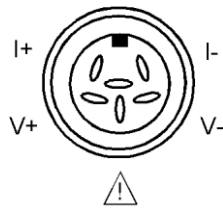
1. De-energize or disconnect all power and signal sources and loads used with unit.
2. Place unit on a grounded conductive work surface.
3. Ground technician through a conductive wrist strap (or other device) using 1 MΩ series resistor to protect operator.

**Handling Electrostatic Discharge Sensitive Components (Continued)**

4. Ground any tools, such as soldering equipment, that will contact unit. Contact with operator's hands provides a sufficient ground for tools that are otherwise electrically isolated.
5. Place ESDS devices and assemblies removed from a unit on a conductive work surface or in a conductive container. An operator inserting or removing a device or assembly from a container must maintain contact with a conductive portion of the container. Use only plastic bags approved for storage of ESD material.
6. Do not handle ESDS devices unnecessarily or remove from the packages until actually used or tested.

**8.7 REAR PANEL CONNECTOR DEFINITIONS**

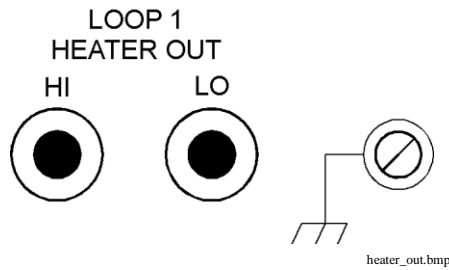
The sensor input, heater output, RS-232, and IEEE-488 connectors are defined in Figures 8-3 through 8-7. For thermocouple connector details, refer to Figure 3-4.



C-325-3-3.bmp

<i>Pin</i>	<i>Symbol</i>	<i>Description</i>
1	I-	- Current
2	V-	- Voltage
3		+1 mA – Model 321/ 330 Configuration Shield – Model 340 Configuration Refer to Section 8.10 for jumper settings that determine the output of this pin and to Section 3.4.1 for a general explanation.
4	V+	+ Voltage
5	I+	+ Current
6	None	Shield

**Figure 8-3. Sensor INPUT A and B Connector Details**

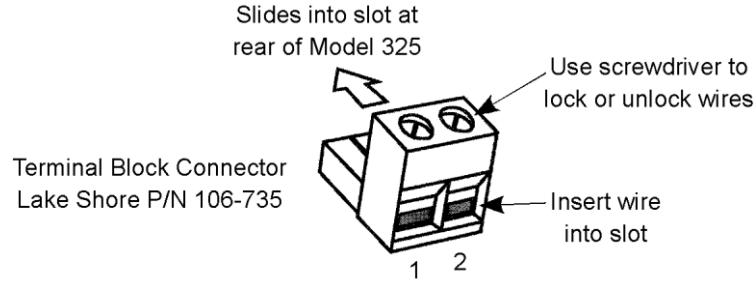


heater\_out.bmp

<i>Pin</i>	<i>Description</i>
1	HI (Banana)
2	LO (Banana)
3	Ground (Screw Terminal)

**Figure 8-4. Loop 1 Heater Output Connector Details**

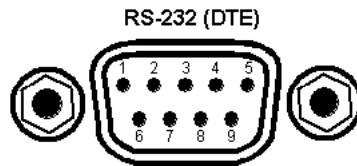




C-325-8-4.bmp

<i>Pin</i>	<i>Description</i>
1	Loop 2 Output – Hi (+)
2	Loop 2 Output – Lo (-)

**Figure 8-5. Loop 2 Heater Output Terminal Block**



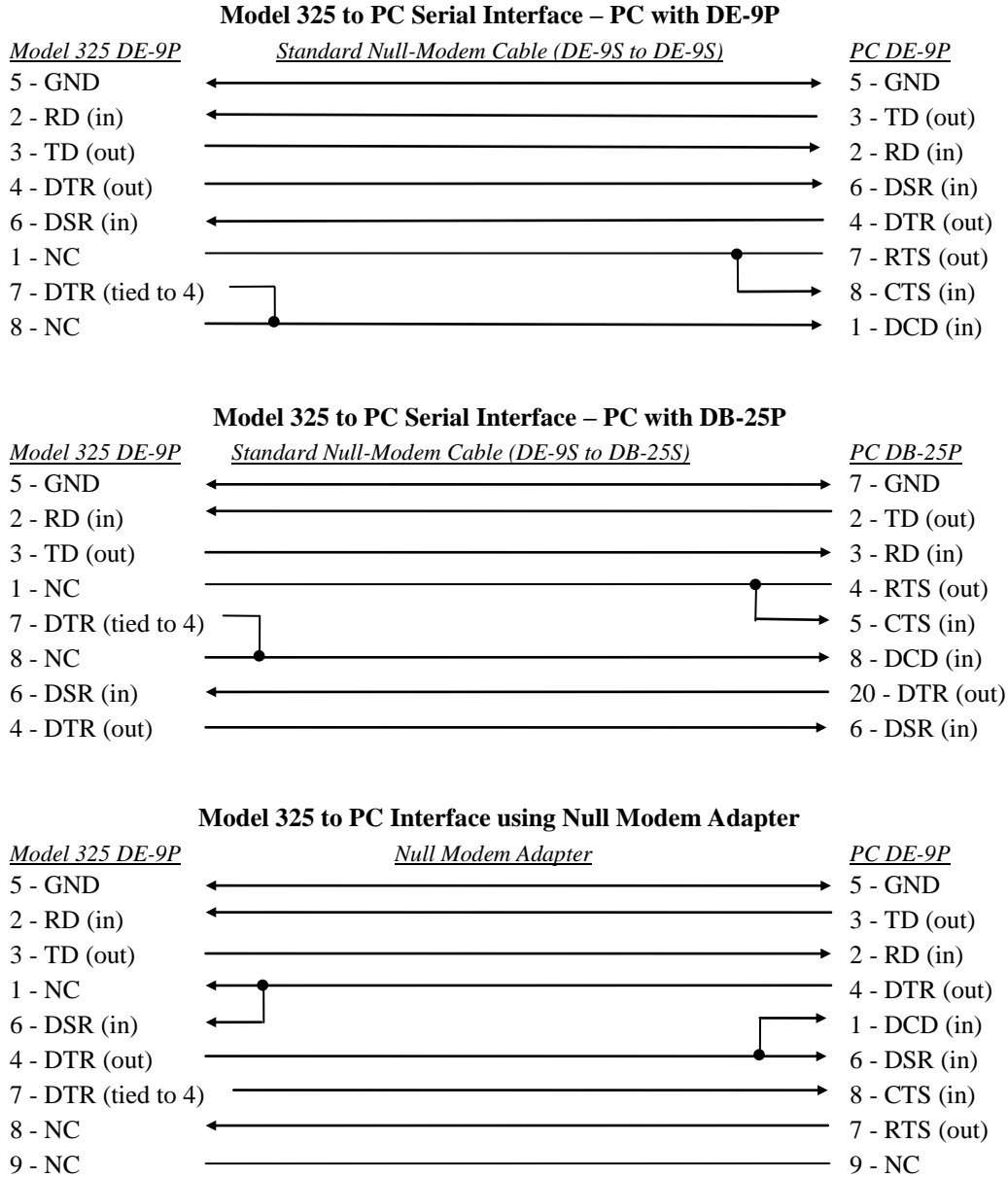
F-325-8-5.bmp

<i>Model 325 Temperature Controller</i>		<i>Typical Computers</i>			
<b>DE-9P (DTE)</b>		<b>DB-25P (DTE)</b>		<b>DE-9P (DTE)</b>	
<i>Pin</i>	<i>Description</i>	<i>Pin</i>	<i>Description</i>	<i>Pin</i>	<i>Description</i>
1	No Connection	2	TD (out)	1	DCD (in)
2	Receive Data (RD in)	3	RD (in)	2	RD (in)
3	Transmit Data (TD out)	4	RTS (out)	3	TD (out)
4	Data Terminal Ready (DTR out)	5	CTS (in)	4	DTR (out)
5	Ground (GND)	6	DSR (in)	5	GND
6	Data Set Ready (DSR in)	7	GND	6	DSR (in)
7	Data Terminal Ready (DTR out) (tied to 4)	8	DCD (in)	7	RTS (out)
8	No Connection	20	DTR (out)	8	CTS (in)
9	No Connection	22	Ring in (in)	9	Ring in (in)

**Figure 8-6. RS-232 Connector Details**

### 8.7.1 Serial Interface Cable Wiring

The following are suggested cable wiring diagrams for connecting the Model 325 serial interface to various customer personal computers (PCs).

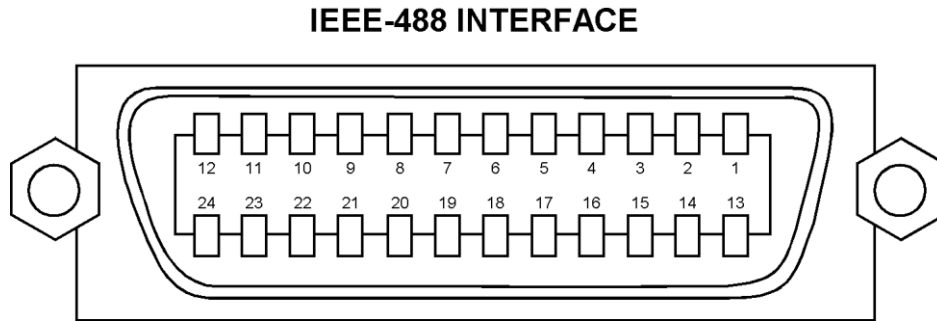


**NOTE:** Same as null modem cable design except PC CTS is provided from the Model 325 on DTR.

### 8.7.2 IEEE-488 Interface Connector

Connect to the IEEE-488 Interface connector on the Model 325 rear with cables specified in the IEEE-488-1978 standard document. The cable has 24 conductors with an outer shield. The connectors are 24-way Amphenol 57 Series (or equivalent) with piggyback receptacles to allow daisy-chaining in multiple device systems. The connectors are secured in the receptacles by two captive locking screws with metric threads.

The total length of cable allowed in a system is 2 m for each device on the bus, or 20 m maximum. The Model 325 can drive a bus of up to 10 devices. A connector extender is required to use the IEEE-488 interface and relay terminal block at the same time. Figure 8-7 shows the IEEE-488 interface connector pin location and signal names as viewed from the Model 325 rear panel.



C-325-8-6.bmp

PIN	SYMBOL	DESCRIPTION
1	DIO 1	Data Input/Output Line 1
2	DIO 2	Data Input/Output Line 2
3	DIO 3	Data Input/Output Line 3
4	DIO 4	Data Input/Output Line 4
5	EOI	End Or Identify
6	DAV	Data Valid
7	NRFD	Not Ready For Data
8	NDAC	Not Data Accepted
9	IFC	Interface Clear
10	SRQ	Service Request
11	ATN	Attention
12	SHIELD	Cable Shield
13	DIO 5	Data Input/Output Line 5
14	DIO 6	Data Input/Output Line 6
15	DIO 7	Data Input/Output Line 7
16	DIO 8	Data Input/Output Line 8
17	REN	Remote Enable
18	GND 6	Ground Wire – Twisted pair with DAV
19	GND 7	Ground Wire – Twisted pair with NRFD
20	GND 8	Ground Wire – Twisted pair with NDAC
21	GND 9	Ground Wire – Twisted pair with IFC
22	GND 10	Ground Wire – Twisted pair with SRQ
23	GND 11	Ground Wire – Twisted pair with ATN
24	GND	Logic Ground

**Figure 8-7. IEEE-488 Rear Panel Connector Details**

## 8.8 TOP OF ENCLOSURE REMOVE AND REPLACE PROCEDURE

**WARNING:** To avoid potentially lethal shocks, turn off controller and disconnect it from AC power line before performing this procedure. Only qualified personnel should perform this procedure.

### REMOVAL

1. Set power switch to Off (O) and disconnect power cord from rear of unit.
2. If attached, remove 19-inch rack mounting brackets.
3. Use 5/64 hex key to remove four screws attaching top panel to unit.
4. Use 5/64 hex key to loosen two rear screws attaching bottom panel to unit.
5. Carefully remove the back bezel by sliding it straight back away from the unit.
6. Slide the top panel back and remove it from the unit.

### INSTALLATION

1. Slide the top panel forward in the track provided on each side of the unit.
2. Carefully replace the back bezel by sliding it straight into the unit.
3. Use 5/64 hex key to install four screws attaching top panel to unit.
4. Use 5/64 hex key to tighten two rear screws attaching bottom panel to unit.
5. If required, reattach 19-inch rack mounting brackets.
6. Connect power cord to rear of unit and set power switch to On (I).

## 8.9 FIRMWARE REPLACEMENT

There are two integrated circuits (ICs) that may potentially require replacement. The location of the ICs is shown in Figure 8-8.

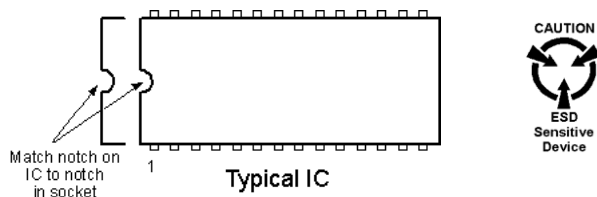
- Input Microcontroller (U11) – Contains software that configures the inputs, takes readings, and performs control functions. Has a sticker on top labeled “M325IF.HEX” and a version number.
- Main Firmware Erasable Programmable Read Only Memory (EPROM) (U48) – Contains the user interface software. Has a sticker on top labeled “M325F.HEX” and a date.

Use the following procedure to replace either of these ICs.

1. Follow the top of enclosure *REMOVAL* procedure in Section 8.8.
2. Locate the IC on the main circuit board. See Figure 8-8. Note orientation of existing IC.

**CAUTION:** The ICs are Electrostatic Discharge Sensitive (ESDS) devices. Wear shock-proof wrist straps (resistor limited to <5 mA) to prevent injury to service personnel and to avoid inducing an Electrostatic Discharge (ESD) into the device.

3. Use IC puller to remove existing IC from the socket.
4. Noting orientation of new IC, use an IC insertion tool to place new device into socket.



5. Follow the top of enclosure *INSTALLATION* procedure in Section 8.8.

## 8.10 JUMPERS

There are five jumpers located on the main circuit board of the Model 325. See Figure 8-8 for the location of the jumpers (reference designators JMP1 through JMP5).

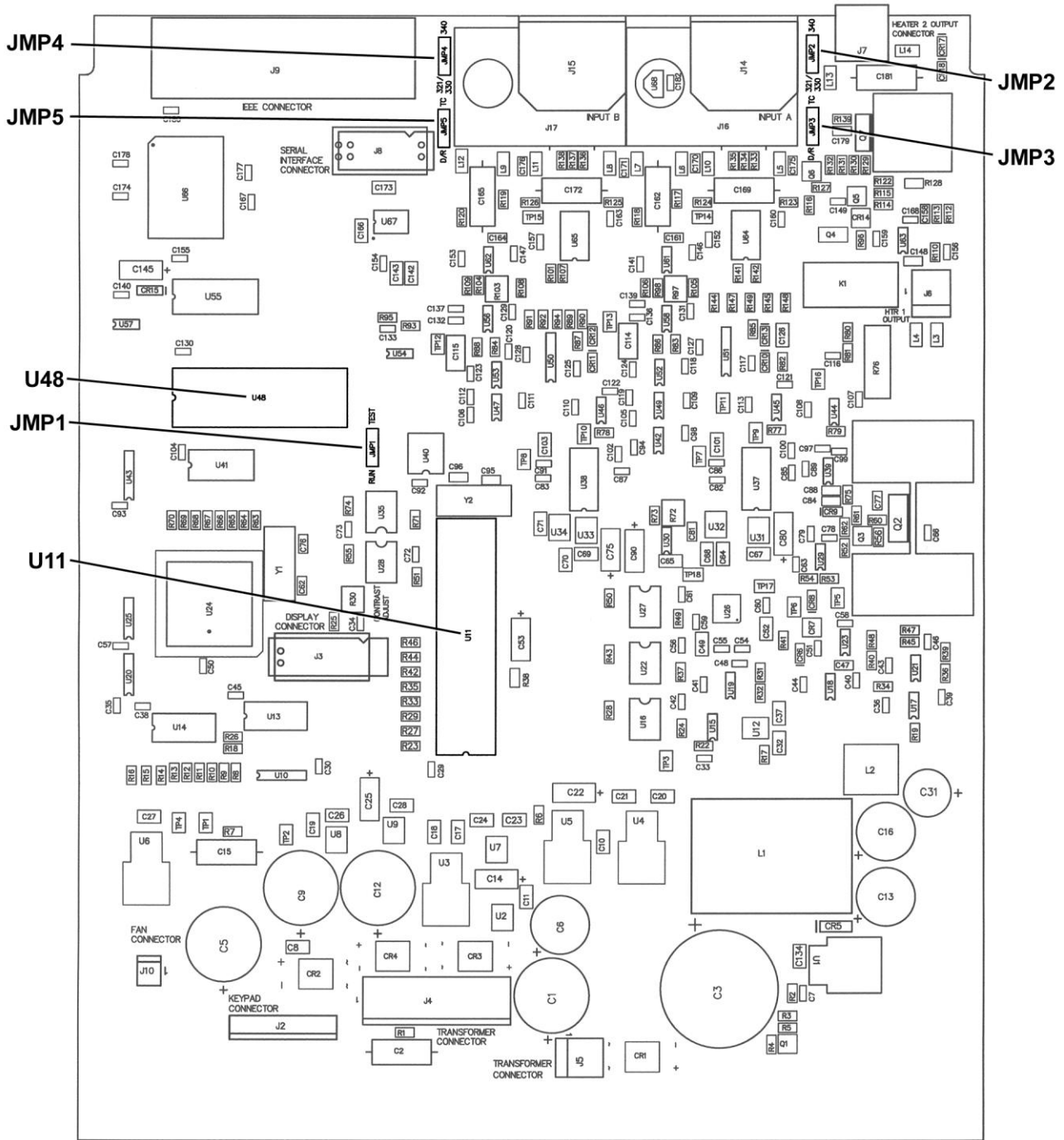
**CAUTION:** Only JMP2 and JMP4 should be changed by the user. Please consult with Lake Shore before changing any of the other jumpers.

<i>Reference Designator</i>	<i>Silkscreen</i>	<i>Default</i>	<i>Description</i>
JMP1	RUN / TEST	RUN	Used for diagnostic purposes only.
JMP2	321 / 330 340	321 / 330	Set at factory to reflect configuration of Input A where 321 / 330 = 1 mA excitation current on Pin 3 of the connector and 340 = Pin 3 connected to shield. Refer to Section 3.4.1.
JMP3	D/R TC	—	Set at factory to reflect configuration of Input A where DI/RE = diode/resistor and TC = thermocouple.
JMP4	321 / 330 340	321 / 330	Set at factory to reflect configuration of Input B where 321 / 330 = 1 mA excitation current on Pin 3 of the connector and 340 = Pin 3 connected to shield. Refer to Section 3.4.1.
JMP5	D/R TC	—	Set at factory to reflect configuration of Input B where DI/RE = diode/resistor and TC = thermocouple.

## 8.11 ERROR MESSAGES

The following are error message that may be displayed by the Model 325 during operation.

<i>Message</i>	<i>Description</i>
<b>Disabled</b>	Input is turned off.
<b>No-Curve</b>	Input has no curve.
<b>S. -Over</b>	Input is at or over full-scale sensor units.
<b>S. -Under</b>	Input is at or under negative full-scale sensor units.
<b>T. -Over</b>	Input at or over the high end of the curve.
<b>T. -Under</b>	Input at or under the low end of the curve.
<b>Cannot Communicate with Input Processor</b>	The main microprocessor has lost communication with the sensor input microprocessor.
<b>Defective NOVRAM</b>	Defective NOVRAM. Contact Lake Shore.
<b>Invalid NOVRAM</b>	Invalid data or contents in NOVRAM – Press and hold the <b>Escape</b> key for ≈20 seconds to initialize NOVRAM. Refer to Section 4.18.



P-325-8-7.bmp

Figure 8-8. Location Of Internal Components

## 8.12 CALIBRATION PROCEDURE

The Model 325 requires calibration of both of the sensor inputs and loop 2 heater output to operate within specification. None of the other circuits require calibration. The sensor inputs may be configured as diode/resistor or thermocouple and the calibration process differs for each. This procedure contains instructions for both input types. Refer to Section 8.12.6 for details on calibration specific interface commands.

### 8.12.1 Equipment Required for Calibration

#### PC and Interface

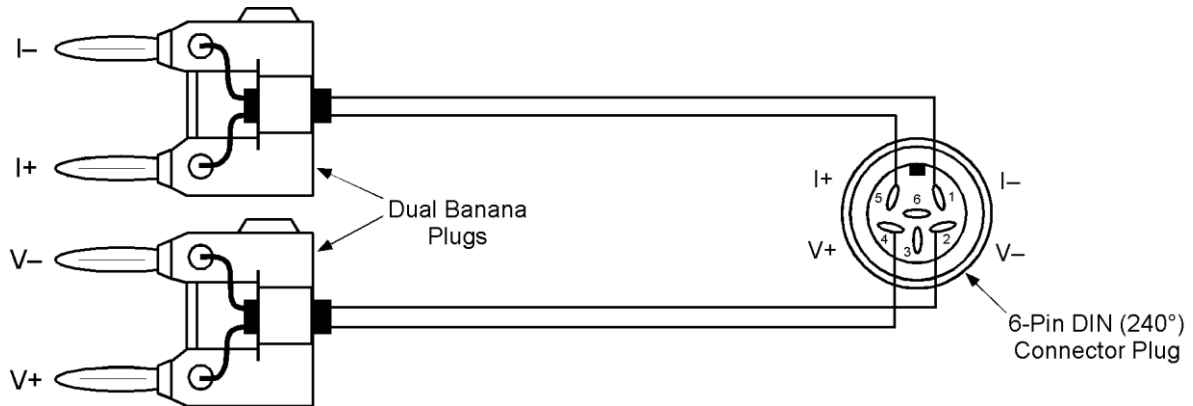
- PC with software loaded which provides serial command line communication. (Example program in Section 6.2.7 is ideal for this purpose.)
- DE-9 to DE-9 cable. Pin to pin connections on all 9 pins. Female connectors on both ends.
- DE-9 null modem adapter.

#### Test and Measurement Equipment

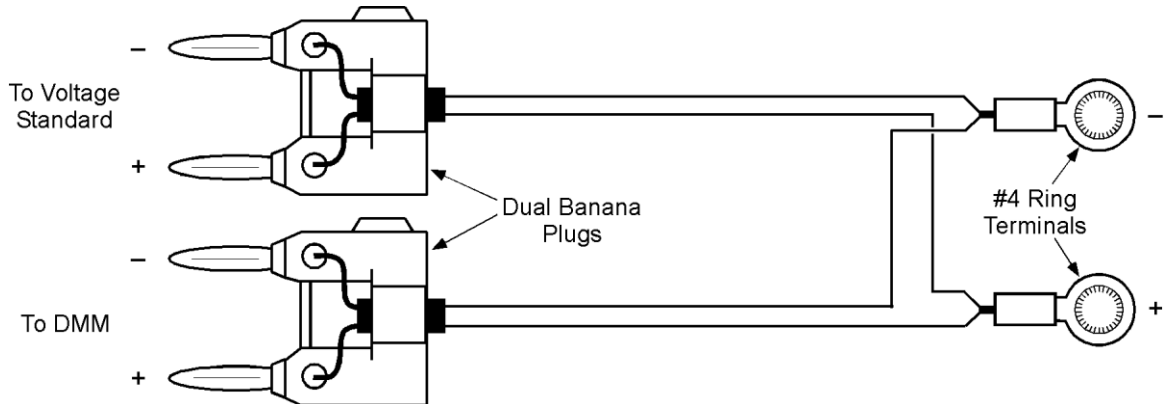
- Digital multimeter (DMM) with minimum of 6 digits resolution. DMM DC voltage and 4-lead resistance specifications to be equivalent to or better than HP 3458A specifications.
- Precision reference providing up to  $\pm 7.5$  V with 1 mV resolution for diode/resistor input calibration.
- Precision reference providing up to  $\pm 50$  mV with 1  $\mu$ V resolution for thermocouple input calibration.

#### Calibration Cables

- Diode/resistor calibration cable (1 required if single or dual diode/resistor unit)



- Thermocouple calibration cable (1 required if single or dual thermocouple unit)



**Equipment Required for Calibration (Continued)****Resistor Standards**

- Resistor standards with the following nominal values (if standards are not available, 0.25 W 25 ppm/°C metal film resistors can be used) — they should have connectors attached to mate with two dual banana plugs for 4-lead measurement
- 0 Ω (short), 10 Ω, 100 Ω, 500 Ω, 1 kΩ, 5 kΩ, 100 kΩ

**Miscellaneous**

- Dummy loads for warm up, 1 each for diode/resistor inputs: 6-pin DIN (240°) connectors — plug, with 100 kΩ resistors configured for 4-lead measurement (calibration cable with 100 kΩ standard can be used)
- Short length of uninsulated wire, 1 each for thermocouple inputs

**8.12.2 Diode/Resistor Sensor Input Calibration**

**NOTE:** The thermocouple input calibration procedure is provided in Section 8.12.3.

**Overview**

Each sensor input requires calibration. Sensor inputs contain a current source that can supply 10 μA or 1 mA of current; only the 10 μA current sources are calibrated. They are calibrated by adjusting pots on the Model 325 main board. The sensor inputs contain multiple gain stages to accommodate the various sensors the Model 325 supports. The input circuitry is not adjusted during calibration. Instead, precision voltages and resistors are attached to each input and mathematical calibration constants are calculated and programmed into the Model 325. Constants are stored to compensate for both input offset and gain errors.

**Calibration Process****8.12.2.1 Sensor Input Calibration Setup and Serial Communication Verification**

Allow the Model 325 to warm up for at least 1 hour with 100 kΩ resistors attached to all inputs configured as diode/resistor and all thermocouple inputs shorted. Connect the Model 325 to the PC via the serial port. Verify serial communication by sending the \*IDN? command and receiving the proper response from the Model 325. If the input not being calibrated is diode/resistor, leave a 100 kΩ resistor attached. If the other input is a thermocouple, leave a short across the input.

**8.12.2.2 10 μA Current Source Calibration and 1 mA Current Source Verification****Purpose**

To calibrate the 10 μA current source to be within the specified tolerance and verify operation of the 1 mA current source.

**Process**

1. Configure the input for the silicon diode range.
2. Accurately determine the value of the 100 kΩ resistor using the DMM. Determine the calibration value by multiplying the actual resistance of the 100 kΩ resistor by 10 μA.  
Example:  $100.050 \text{ k}\Omega \times 10 \times 10^{-6} \text{ A} = 1.00050 \text{ V}$ .
3. Attach the 100 kΩ resistor to the Model 325 input using proper 4-lead connection techniques, configure the DMM to read VDC and attach to the resistor.
4. Adjust the current source calibration pot, (R97 for Input A and R103 for Input B), on the Model 325 main board until the DMM reads exactly the value calculated in Step 2 to ±0.00002 VDC.
5. 1 mA current source verification. Configure the input for the 100Ω Plat/250 range.
6. Accurately determine the value of the 1 kΩ resistor using the DMM. Determine the verification value by multiplying the actual resistance of the 1 kΩ resistor by 1 mA.
7. Attach the 1 kΩ resistor to the Model 325 input using proper 4-lead connection techniques, configure the DMM to read VDC and attach to the resistor.
8. Verify the voltage across resistor to be within ±0.3% of the value calculated in Step 6.



### 8.12.2.3 Diode Input Ranges Calibration

**Purpose**

To determine the input offset and gain errors when the input is configured for the diode ranges and provide offset and gain calibration constants back to the Model 325.

**Process**

1. Configure the input for the diode range to be calibrated.
2. Reset the calibration constants to their default values using the CALZ and CALG commands.

**EXAMPLE:**  
 Input: A  
 Range: GaAlAs Diode  
 Zero Offset Command: **CALZ A,1,0**  
 Gain Command: **CALG A,1,1**

3. Short all four terminals, (I+, I-, V+, V-), of the input together, do not tie the terminals to ground.
4. Via the interface obtain the input reading using the **CALREAD?** command and record this number.
5. Program the offset calibration by negating the value read in the previous step and providing it using the **CALZ** command.

**EXAMPLE:**  
 Input: A  
 Range: GaAlAs Diode  
**CALREAD?** Reading: +0.00005  
 Calibration Command: **CALZ A,1,-0.00005**

6. Disconnect the V+ terminal from the others and connect to the positive output of the voltage reference. Connect the voltage reference negative output to the V-, I+, and I- terminals.
7. Set the voltage reference to provide the calibration voltage shown in Table 8-1. Using the DMM measure the voltage to the tolerance shown in Table 8-1.
8. Via the interface obtain the input reading using the **CALREAD?** command and record this number.
9. Program the gain calibration by dividing the measured value of the reference voltage by the value read in the previous step and provide the result using the **CALG** command. Note that the gain calibration constant will always be within 5% of 1.00000.

**EXAMPLE:**  
 Input: A  
 Range: GaAlAs Diode  
 Measured Value of Reference Voltage: 7.50002 VDC  
**CALREAD?** Reading: 7.49852  
 Constant Calculation:  $7.50002 / 7.49852 = 1.00020$   
 Calibration Command: **CALG A,1,1.00020**

10. Send the **CALSAVE** command to save the constants in the EEPROM.
11. Perform calibration on both diode ranges.

**Table 8-1. Calibration Table for Diode Ranges**

Range	Voltage Reference Output	Reference Voltage Known To	Cal. Command Type Number
Silicon Diode	2.5 VDC	±0.00010 VDC	0
GaAlAs Diode	7.5 VDC	±0.00040 VDC	1

### 8.12.2.4 Resistive Input Ranges Calibration

#### Purpose

To determine the input offset and gain errors when the input is configured for the resistive ranges and provide offset and gain calibration constants back to the Model 325. This step will calibrate all resistive ranges with reversing both on and off.

#### Process

1. Configure the input for the resistive range to be calibrated.
2. Reset the calibration constants to their default values using the **CALZ** and **CALG** commands.

#### EXAMPLE:

Input: A  
 Range: 100 $\Omega$  Plat/250, Reversal Off  
 Zero Offset Command: **CALZ A,2,0**  
 Gain Command: **CALG A,2,1**

3. Short all four terminals, (I+, I-, V+, V-), of the input together, do not tie the terminals to ground.
4. Via the interface obtain the input reading using the **CALREAD?** command and record this number.
5. Program the offset calibration by negating the value read in the previous step and providing it using the **CALZ** command.

#### EXAMPLE:

Input: A  
 Range: 100 $\Omega$  Plat/250, Reversal Off  
**CALREAD?** Reading: +000.003  
 Calibration Command: **CALZ A,2,-0.003**

6. From Table 8-2 select the calibration resistor for the range being calibrated and use the DMM in 4-lead resistance measurement mode to measure the value of the resistor to the tolerance shown.
7. Attach the calibration resistor to the Model 325 sensor input. Be sure to connect the resistor using proper 4-lead connection techniques.
8. Via the interface obtain the input reading using the **CALREAD?** command and record this number.
9. Program the gain calibration by dividing the actual resistance of the calibration resistor by the value read in the previous step and provide the result using the **CALG** command. Note that the gain calibration constant will always be within 5% of 1.00000.

#### EXAMPLE:

Input: A  
 Range: 100 $\Omega$  Plat/250, Reversal Off  
 Measured Value of Calibration Resistor: 100.0250 $\Omega$   
**CALREAD?** Reading: 100.145  
 Constant Calculation:  $100.0250 / 100.145 = 0.99880$   
 Calibration Command: **CALG A,2,0.99880**

10. Send the **CALSAVE** command to save the constants in the EEPROM.
11. Repeat the resistive input ranges calibration for all resistive ranges with reversal on and off.
12. Repeat all of Section 8.12.2 for second input if diode/resistor.

**Table 8-2. Calibration Table for Resistive Ranges**

<i>Range</i>	<i>Calibration Resistor Nominal Value</i>	<i>Resistor Value Known to</i>	<i>Reversal</i>	<i>Cal. Command Type Number</i>
100 $\Omega$ Plat/250	100 $\Omega$	$\pm 0.0070 \Omega$	Off	2
100 $\Omega$ Plat/250	100 $\Omega$	$\pm 0.0070 \Omega$	On	10
100 $\Omega$ Plat/500	500 $\Omega$	$\pm 0.0270 \Omega$	Off	3
100 $\Omega$ Plat/500	500 $\Omega$	$\pm 0.0270 \Omega$	On	11
1000 $\Omega$ Plat	5 k $\Omega$	$\pm 0.520 \Omega$	Off	4
1000 $\Omega$ Plat	5 k $\Omega$	$\pm 0.520 \Omega$	On	12
NTC RTD	5 k $\Omega$	$\pm 0.520 \Omega$	Off	5
NTC RTD	5 k $\Omega$	$\pm 0.520 \Omega$	On	13

### 8.12.3 Diode Sensor Input Calibration – 1 mA Excitation Current

The instrument uses the calibration constants determined in the Diode Input Ranges Calibration (Section 8.12.2.3), for the diode ranges that use 1 mA excitation. Therefore, no additional calibration is necessary.

**NOTE:** Standard diode curves and typical sensor performance (Table 1-2) are calculated using 10  $\mu$ A excitation. Sensor temperature response characteristics will be altered if 1 mA excitation is selected.

### 8.12.4 Thermocouple Sensor Input Calibration

#### Overview

Each thermocouple sensor input requires calibration. The sensor inputs contain multiple gain stages to accommodate the various thermocouple sensors the Model 325 supports. The input circuitry is not adjusted during calibration. Instead, precision voltages are supplied to each input and mathematical calibration constants are calculated and programmed into the Model 325. Constants are stored to compensate for both input offset and gain errors. Thermocouple inputs do not use the current source.

#### Calibration Process

##### 8.9.4.1 Sensor Input Calibration Setup

Allow the Model 325 to warm up for at least 1 hour with shorts placed across all thermocouple sensor inputs. If calibrating a dual thermocouple Model 325, leave a short across the input not currently being calibrated. If the other input is diode/resistor, place a 100 k $\Omega$  resistor on the input.

**CAUTION:** All thermocouple connections must be tight and direct with no unnecessary jumpers or connections.

##### 8.12.4.2 Thermocouple Input Ranges Calibration

#### Purpose

To determine the input offset and gain errors when the input is configured for the thermocouple ranges and provide offset and gain calibration constants back to the Model 325.

#### Process

1. Configure the input for the thermocouple range to be calibrated. Turn Room Cal off.
2. Reset the calibration constants to their default values using the **CALZ** and **CALG** commands.

#### EXAMPLE:

Input: A  
 Range: Thermo/25mV  
 Zero Offset Command: **CALZ A,6,0**  
 Gain Command: **CALG A,6,1**

3. Short the V+ and V– terminals together, do not tie the terminals to ground.
4. Via the interface obtain the input reading using the **CALREAD?** command and record this number.

**Thermocouple Input Ranges Calibration (Continued)**

5. Program the offset calibration by negating the value read in the previous step and providing it using the **CALZ** command.

**EXAMPLE:**  
 Input: A  
 Range: Thermo/25mV  
**CALREAD?** Reading: -00.0122  
 Calibration Command: **CALZ A,6,+0.0122**

6. Connect input to standard and DMM with cable described in Section 8.12.1.
7. Set the voltage reference to provide the calibration voltage shown in Table 8-3. Using the DMM measure the voltage to the tolerance shown in Table 8-3.
8. Via the interface obtain the input reading using the **CALREAD?** command and record this number.
9. Program the gain calibration by dividing the measured value of the reference voltage by the value read in the previous step and provide the result using the **CALG** command. Note that the gain calibration constant will always be within 5% of 1.00000.

**EXAMPLE:**  
 Input: A  
 Range: Thermo/25mV  
 Measured Value of Reference Voltage: +25.0032 mV DC  
**CALREAD?** Reading: +24.9867  
 Constant Calculation:  $+25.0032 / +24.9867 = 1.00066$   
 Calibration Command: **CALG A,6,1.00066**

10. Send the **CALSAVE** command to save the constants in the EEPROM.
11. Perform calibration on both thermocouple ranges.
12. Repeat for second input if thermocouple.

**Table 8-3. Calibration Table for Thermocouple Ranges**

<i>Range</i>	<i>Voltage Reference Output</i>	<i>Reference Voltage Known to</i>	<i>Cal. Command Type Number</i>
Thermo/25mV	+25 mV DC	±0.0070 mV DC	6
Thermo/50mV	+50 mV DC	±0.0130 mV DC	7

**8.12.5 Loop 2 Heater Calibration**

**Overview**

The Model 325 has a second control loop output, which requires calibration. Zero offset and gain errors are calibrated out by programming offset and gain constants to the instrument.

**Calibration Process**

**8.12.5.1 Loop 2 Voltage Output Calibration**

**Purpose**

To determine the Loop 2 output offset and gain errors and provide offset and gain calibration constants back to the Model 325.

**Process**

1. Reset the calibration constants to their default values using the **CALZ** and **CALG** commands.

**EXAMPLE:**  
 Zero Offset Command: **CALZ V,1,0**  
 Gain Command: **CALG V,1,1**

2. Connect the 100 kΩ resistor to the loop 2 heater output. Connect the positive lead of the DMM to the Loop 2 heater output positive terminal, the negative lead is connected to the Loop 2 output negative terminal.

**Loop 2 Voltage Output Calibration (Continued)**

3. Set Loop 2 output to open loop operation and set manual output of 0%. Read the output voltage with the DMM to a tolerance of  $\pm 0.0001$  VDC and record as Zero Offset (ZO).
4. Set Loop 2 manual output to 100%. Read the output voltage with the DMM to a tolerance of  $\pm 0.0010$  and record as Full Scale (FS).
5. Calculate the gain factor by dividing 10 by the full output span (gain factor =  $10 / (FS - ZO)$ ).
6. Program the offset calibration by negating the Zero Offset value read in step 3 and providing it using the **CALZ** command.

**EXAMPLE:**

Zero Offset DMM Reading: -0.0231  
 Calibration Command: **CALZ V,1,+0.0231**

7. Program the gain calibration factor using the **CALG** command.

**EXAMPLE:**

Zero Offset DMM Reading: -0.0231  
 Full Scale DMM Reading: +10.0432  
 Gain Factor Calculation:  $10 / (10.0432 - (-0.0231)) = 0.99341$   
 Calibration Command: **CALG V,1,0.99341**

9. Send the **CALSAVE** command to save the constants in the EEPROM.

**8.12.6 Calibration Specific Interface Commands**

**CALG**

Gain Calibration Constant Command

**Input:** **CALG** <input>, <type>, <value>[term]

**Format:** a,nn,±nnnnnnnn

<input> Specifies which input or Loop 2 output the gain calibration constant will be provided to. Valid entries are A or B for inputs and V for the Loop 2 output.

<type> Specifies the input sensor type. Valid entries are:  
 0 = Silicon Diode or **Loop 1 Heater (not used)**      6 = Thermo/25mV  
 1 = GaAlAs Diode or **Loop 2 Heater**                      7 = Thermo/50mV  
 2 = 100Ω Plat/250 – Reversal Off                      10 = 100Ω Plat/250 – Reversal On  
 3 = 100Ω Plat/500 – Reversal Off                      11 = 100Ω Plat/500 – Reversal On  
 4 = 1000Ω Plat – Reversal Off                          12 = 1000Ω Plat – Reversal On  
 5 = NTC RTD – Reversal Off                            13 = NTC RTD – Reversal On

<value> Gain calibration constant value.

**Remarks:** Provides the gain calibration constant for the selected input or Loop 2 output.

**CALG?**

Gain Calibration Constant Query

**Input:** **CALG?** <input>, <type>[term]

**Format:** a,nn

<input> A, B, or V

<type> 0–7 or 10–13

**Returned:** <value>[term]

**Format:** ±nnnnnnnn (Refer to command for description)

**CALREAD?** Six Digit Input Reading Query  
**Input:** **CALREAD?** <input>[term]  
**Format:** a  
 <input> A or B  
**Returned:** <value>[term]  
**Format:** ±n.nnnnn  
**Remarks:** Returns 6-digit value of selected input reading. Used for CALZ and CALG functions.

**CALSAVE** Calibration Save Command  
**Input:** **CALSAVE** [term]  
**Remarks:** Saves all CALZ and CALG calibration constants to the EEPROM.

**CALZ** Zero Offset Calibration Constant Command  
**Input:** **CALZ** <input>, <type>, <value>[term]  
**Format:** a,nn,±nnnnnnn  
 <input> Specifies which input or Loop 2 output the zero offset calibration constant will be provided to. Valid entries are A or B for inputs and V for the Loop 2 output.  
 <type> Specifies the input sensor type. Valid entries are:  
 0 = Silicon Diode or **Loop 1 Heater (not used)**      6 = Thermo/25mV  
 1 = GaAlAs Diode or **Loop 2 Output**                      7 = Thermo/50mV  
 2 = 100Ω Plat/250 – Reversal Off                      10 = 100Ω Plat/250 – Reversal On  
 3 = 100Ω Plat/500 – Reversal Off                      11 = 100Ω Plat/500 – Reversal On  
 4 = 1000Ω Plat – Reversal Off                      12 = 1000Ω Plat – Reversal On  
 5 = NTC RTD – Reversal Off                      13 = NTC RTD – Reversal On  
 <value> Zero offset calibration constant value.  
**Remarks:** Provides the zero offset calibration constant for the selected input or Loop 2 output.

**CALZ?** Zero Offset Calibration Constant Query  
**Input:** **CALZ?** <input>, <type>[term]  
**Format:** a,nn  
 <input> A, B, or V  
 <type> 0 – 7 or 10 – 13  
**Returned:** <value>[term]  
**Format:** ±nnnnnnn (Refer to command for description)

**KEYST?** Last Key Press Query  
**Input:** **KEYST?** [term]  
**Returned:** <code>[term]  
**Format:** nn  
**Remarks:** Code returned indicates the last key that was pressed according to the table below.

00 = no key pressed since last query	08 = "5"	16 = "Set Point"
01 = "Heater Range"	09 = "6"	17 = "0"
02 = "7"	10 = "Up"	18 = "."
03 = "8"	11 = "Loop"	19 = "+/-"
04 = "9"	12 = "1"	20 = "Enter"
05 = "Escape"	13 = "2"	21 = no key pressed since power-up
06 = "Heater Off"	14 = "3"	99 = multiple keys pressed simultaneously
07 = "4"	15 = "Down"	

# APPENDIX A

## GLOSSARY OF TERMINOLOGY

**absolute zero.** The temperature of  $-273.16\text{ }^{\circ}\text{C}$ , or  $-459.69\text{ }^{\circ}\text{F}$ , or  $0\text{ K}$ , thought to be the temperature at which molecular motion vanishes and a body would have no heat energy.<sup>1</sup>

**Alumel™.** An aluminum-nickel alloy of which the negative lead of a Type K thermocouple is composed.

**ambient temperature.** The temperature of the surrounding medium, such as gas or liquid, which comes into contact with the apparatus.<sup>1</sup>

**ampere.** The constant current that, if maintained in two straight parallel conductors of infinite length, of negligible circular cross section, and placed one meter apart in a vacuum, would produce between these conductors a force equal to  $2 \times 10^{-7}$  newton per meter of length.<sup>2</sup> This is one of the base units of the SI.

**ampere-turn.** A MKS unit of magnetomotive force equal to the magnetomotive force around a path linking one turn of a conducting loop carrying a current of one ampere; or 1.26 gilberts.

**ampere/meter (A/m).** The SI unit for magnetic field strength (H). 1 ampere/meter =  $4\pi/1000$  oersted  $\approx 0.01257$  oersted.

**analog controller.** A feedback control system where there is an unbroken path of analog processing between the feedback device (sensor) and control actuator (heater).

**analog output.** A voltage output from an instrument that is proportional to its input. For example, from a digital voltmeter the output voltage is generated by a digital-to-analog converter so it has a discrete number of voltage levels.

**anode.** The terminal that is positive with respect to the other terminal when the diode is biased in the forward direction.<sup>2</sup>



**asphyxiant gas.** A gas which has little or no positive toxic effect but which can bring about unconsciousness and death by displacing air and thus depriving an organism of oxygen.

**AutoTuning.** In Lake Shore temperature controllers, the AutoTuning algorithm automatically determines the proper settings for Gain (Proportional), Reset (Integral), and Rate (Derivative) by observing the time response of the system upon changes in setpoint.

**B.** Symbol for magnetic flux density. *See* Magnetic Flux Density.

**bar.** Unit of pressure equal to  $10^5$  pascal, or 0.98697 standard atmosphere.

**baud.** A unit of signaling speed equal to the number of discrete conditions or signal events per second, or the reciprocal of the time of the shortest signal element in a character.<sup>2</sup>

**bel (B).** A dimensionless unit expressing the ration of two powers or intensities, or the ratio of a power to a reference power, such that the number of bels is the common logarithm of this ratio.<sup>1</sup>

**bifilar windings.** A winding consisting of two insulated wires, side by side, with currents traveling through them in opposite directions.<sup>1</sup>

**boiling point.** The temperature at which a substance in the liquid phase transforms to the gaseous phase; commonly refers to the boiling point at sea level and standard atmospheric pressure.

**CalCurve™ service.** The service of storing a mathematical representation of a calibration curve on an EEPROM or installed in a Lake Shore instrument. Previously called Precision Option.

**calibrate.** To determine, by measurement or comparison with a standard, the correct value of each scale reading on a meter or other device, or the correct value for each setting of a control knob.<sup>1</sup>

**cathode.** The terminal from which forward current flows to the external circuit.<sup>2</sup>



**Carbon-Glass.** A temperature sensing material fabricated from a carbon-impregnated glass matrix used to make the Lake Shore CGR family of sensors.

**Celsius (°C) Scale.** A temperature scale that registers the freezing point of water as  $0\text{ }^{\circ}\text{C}$  and the boiling point as  $100\text{ }^{\circ}\text{C}$  under normal atmospheric pressure. Celsius degrees are purely derived units, calculated from the Kelvin Thermodynamic Scale. Formerly known as “centigrade.” *See* Temperature for conversions.

**Cernox™.** A Lake Shore resistance temperature detector based on a ceramic-oxy-nitride resistance material.

**CGR.** Carbon glass resistor.

**cgs system of units.** A system in which the basic units are the centimeter, gram, and second.<sup>2</sup>

**Chebyshev polynomials.** A family of orthogonal polynomials that solve Chebyshev's differential equation.<sup>1</sup>

**Chebyshev differential equation.** A special case of Gauss' hypergeometric second-order differential equation:  
 $(1 - x^2) f''(x) - x f'(x) + n^2 f(x) = 0$ .<sup>1</sup>

**Chromel™.** A chromium-nickel alloy of which the positive lead of Type E and K thermocouples is composed.

**closed-loop.** *See* feedback control system.

- coercive force (coercive field).** The magnetic field strength (H) required to reduce the magnetic induction (B) in a magnetic material to zero.
- coercivity.** Generally used to designate the magnetic field strength (H) required to reduce the magnetic induction (B) in a magnetic material to zero from saturation. The coercivity would be the upper limit to the coercive force.
- Constantan.** A copper-nickel alloy of which the negative lead of Type E, J, and T thermocouples are composed.
- cryogenic.** Refers to the field of low temperatures, usually  $-130\text{ }^{\circ}\text{F}$  or below, as defined by 173.300(f) of Title 49 of the Code of Federal Regulations.
- cryogenic fluid.** A liquid that boils at temperatures of less than about 110 K at atmospheric pressure, such as hydrogen, helium, nitrogen, oxygen, air, or methane. Also known as cryogen.<sup>1</sup>
- cryostat.** An apparatus used to provide low-temperature environments in which operations may be carried out under controlled conditions.<sup>1</sup>
- cryotronics.** The branch of electronics that deals with the design, construction, and use of cryogenic devices.<sup>1</sup>
- Curie temperature (T<sub>c</sub>).** Temperature at which a magnetized sample is completely demagnetized due to thermal agitation. Named for Pierre Curie (1859 – 1906), a French chemist.
- current source.** A type of power supply that supplies a constant current through a variable load resistance by automatically varying its compliance voltage. A single specification given as “compliance voltage” means the output current is within specification when the compliance voltage is between zero and the specified voltage.
- curve.** A set of data that defines the temperature response of a temperature sensor. It is used to convert the signal from the sensor to temperature.
- Curve 10.** The voltage vs. temperature characteristic followed by all DT-400 Series silicon diode temperature sensors.
- degree.** An incremental value in the temperature scale, i.e., there are 100 degrees between the ice point and the boiling point of water in the Celsius scale and 180 degrees between the same two points in the Fahrenheit scale.
- demagnetization.** When a sample is exposed to an applied field (H<sub>a</sub>), poles are induced on the surface of the sample. Some of the returned flux from these poles is inside of the sample. This returned flux tends to decrease the net magnetic field strength internal to the sample yielding a true internal field (H<sub>int</sub>) given by:  $H_{int} = H_a - DM$ , where M is the volume magnetization and D is the demagnetization factor. D is dependent on the sample geometry and orientation with respect to the field.
- deviation.** The difference between the actual value of a controlled variable and the desired value corresponding to the setpoint.<sup>1</sup>
- Dewar flask.** A vessel having double walls, the space between being evacuated to prevent the transfer of heat and the surfaces facing the vacuum being heat-reflective; used to hold liquid gases and to study low-temperature phenomena.<sup>1</sup> Invented by Sir James Dewar (1842 – 1923), a Scottish physical chemist.
- differential permeability.** The slope of a B versus H curve:  $\mu_d = dB/dH$ .
- differential susceptibility.** The slope of a M versus H curve:  $\chi_d = dM/dH$ .
- dimensionless sensitivity.** Sensitivity of a physical quantity to a stimulus, expressed in dimensionless terms. The dimensionless temperature sensitivity of a resistance temperature sensor is expressed as  $S_d = (T/R)(dR/dT)$  which is also equal to the slope of R versus T on a log-log plot, that is  $S_d = d \ln R / d \ln T$ . Note that the absolute temperature (in kelvin) must be used in these expressions.
- drift, instrument.** An undesired but relatively slow change in output over a period of time, with a fixed reference input. *Note:* drift is usually expressed in percent of the maximum rated value of the variable being measured.<sup>2</sup>
- electromagnet.** A device in which a magnetic field is generated as the result of electrical current passing through a helical conducting coil. It can be configured as an iron-free solenoid in which the field is produced along the axis of the coil, or an iron-cored structure in which the field is produced in an air gap between pole faces. The coil can be water cooled copper or aluminum, or superconductive.
- electrostatic discharge (ESD).** A transfer of electrostatic charge between bodies at different electrostatic potentials caused by direct contact or induced by an electrostatic field.
- error.** Any discrepancy between a computed, observed, or measured quantity and the true, specified, or theoretically correct value or condition.<sup>2</sup>
- excitation.** Either an AC or DC input to a sensor used to produce an output signal. Common excitations include: constant current, constant voltage, or constant power.
- Fahrenheit (°F) Scale.** A temperature scale that registers the freezing point of water as 32 °F and the boiling point as 212 °F under normal atmospheric pressure. *See* Temperature for conversions.
- feedback control system.** A system in which the value of some output quantity is controlled by feeding back the value of the controlled quantity and using it to manipulate an input quantity so as to bring the value of the controlled quantity closer to a desired value. Also known as closed-loop control system.<sup>1</sup>
- four-lead.** measurement technique where one pair of excitation leads and an independent pair of measurement leads are used to measure a sensor. This method reduces the effect of lead resistance on the measurement.
- GaAlAs.** Gallium-aluminum-arsenide semiconducting material used to make the special Lake Shore TG family of diode temperature sensors.
- gamma.** A cgs unit of low-level flux density, where 100,000 gamma equals one oersted, or 1 gamma equals  $10^{-5}$  oersted.



- gauss (G).** The cgs unit for magnetic flux density (B).  $1 \text{ gauss} = 10^{-4} \text{ tesla}$ . Named for Karl Fredrich Gauss (1777–1855) a German mathematician, astronomer, and physicist.
- gaussian system (units).** A system in which centimeter-gram-second units are used for electric and magnetic qualities.
- general purpose interface bus (GPIB).** Another term for the IEEE-488 bus.
- germanium (Ge).** A common temperature sensing material fabricated from doped germanium to make the Lake Shore GR family of resistance temperature sensor elements.
- gilbert (Gb).** A cgs electromagnetic unit of the magnetomotive force required to produce one maxwell of magnetic flux in a magnetic circuit of unit reluctance. One gilbert is equal to  $10/4\pi$  ampere-turn. Named for William Gilbert (1540–1603), an English physicist; hypothesized that the earth is a magnet.
- gilbert per centimeter.** Practical cgs unit of magnet intensity. Gilberts per cm are the same as oersteds.
- ground.** A conducting connection, whether intentional or accidental, by which an electric circuit or equipment is connected to the earth, or to some conducting body of relatively large extent that serves in place of the earth.  
*Note:* It is used for establishing and maintaining the potential of the earth (or of the conducting body) or approximately that potential, on conductors connected to it, and for conducting ground current to and from the earth (or of the conducting body).<sup>2</sup>
- H.** Symbol for magnetic field strength. *See* Magnetic Field Strength.
- Hall effect.** The generation of an electric potential perpendicular to both an electric current flowing along a thin conducting material and an external magnetic field applied at right angles to the current. Named for Edwin H. Hall (1855–1938), an American physicist.
- hazard communication standard (HCS).** The OSHA standard cited in 29 CFR 1910.1200 requiring communication of risks from hazardous substances to workers in regulated facilities.
- hertz (Hz).** A unit of frequency equal to one cycle per second.
- hysteresis.** The dependence of the state of a system on its previous history, generally in the form of a lagging of a physical effect behind its cause.<sup>1</sup> Also *see* magnetic hysteresis.
- IEEE-488.** An instrumentation bus with hardware and programming standards designed to simplify instrument interfacing. The addressable, parallel bus specification is defined by the IEEE.
- initial permeability.** The permeability determined at  $H = 0$  and  $B = 0$ .
- initial susceptibility.** The susceptibility determined at  $H = 0$  and  $M = 0$ .
- interchangeability.** Ability to exchange one sensor or device with another of the same type without a significant change in output or response.
- international system of units (SI).** A universal coherent system of units in which the following seven units are considered basic: meter, kilogram, second, ampere, kelvin, mole, and candela. The International System of Units, or *Système International d'Unités* (SI), was promulgated in 1960 by the Eleventh General Conference on Weights and Measures. For definition, spelling, and protocols, *see* Reference 3 for a short, convenient guide.
- interpolation table.** A table listing the output and sensitivity of a sensor at regular or defined points, which may be different from the points at which calibration data was taken.
- intrinsic coercivity.** The magnetic field strength (H) required to reduce the magnetization (M) or intrinsic induction in a magnetic material to zero.
- intrinsic induction.** The contribution of the magnetic material ( $B_i$ ) to the total magnetic induction (B).  

$$B_i = B - \mu_0 H \quad (\text{SI}) \qquad B_i = B - H \quad (\text{cgs})$$
- IPTS-68.** International Practical Temperature Scale of 1968. Also abbreviated as  $T_{68}$ .
- isolated** (neutral system). A system that has no intentional connection to ground except through indicating, measuring, or protective devices of very-high impedance.<sup>2</sup>
- ITS-90.** International Temperature Scale of 1990. Also abbreviated as  $T_{90}$ . This scale was designed to bring into as close a coincidence with thermodynamic temperatures as the best estimates in 1989 allowed.
- kelvin (K).** The unit of temperature on the Kelvin Scale. It is one of the base units of SI. The word “degree” and its symbol (°) are omitted from this unit. *See* Temperature Scale for conversions.
- Kelvin Scale.** The Kelvin Thermodynamic Temperature Scale is the basis for all international scales, including the ITS-90. It is fixed at two points: the absolute zero of temperature (0 K), and the triple point of water (273.16 K), the equilibrium temperature that pure water reaches in the presence of ice and its own vapor.
- line regulation.** The maximum steady-state amount that the output voltage or current changes as result of a specified change in input line voltage (usually for a step change between 105–125 or 210–250 volts, unless otherwise specified).
- line voltage.** The RMS voltage of the primary power source to an instrument.
- liquid helium (LHe).** Used for low temperature and superconductivity research: minimum purity 99.998%. Boiling point at 1 atm = 4.2 K. Latent heat of vaporization = 2.6 kilojoules per liter. Liquid density = 0.125 kilograms per liter.  
 EPA Hazard Categories: Immediate (Acute) Health and Sudden Release of Pressure Hazards  
 DOT Name: Helium, Refrigerated Liquid  
 DOT Label: Nonflammable Gas  
 DOT Class: Nonflammable Gas  
 DOT ID No.: UN 1963

**liquid nitrogen (LN<sub>2</sub>).** Also used for low temperature and superconductivity research and for its refrigeration properties such as in freezing tissue cultures: minimum purity 99.998%, O<sub>2</sub> 8 ppm max. Boiling point at 1 atm = 77.4 K. Latent heat of vaporization = 160 kilojoules per liter. Liquid density = 0.81 kilograms per liter.

EPA Hazard Categories: Immediate (Acute) Health and Sudden Release of Pressure Hazards

DOT Name: Nitrogen, Refrigerated Liquid

DOT Label: Nonflammable Gas

DOT Class: Nonflammable Gas

DOT ID No.: UN 1977

**load regulation.** A steady-state decrease of the value of the specified variable resulting from a specified increase in load, generally from no-load to full-load unless otherwise specified.

**M.** Symbol for magnetization. *See* magnetization.

**magnetic air gap.** The air space, or non-magnetic portion, of a magnetic circuit.

**magnetic field strength (H).** The magnetizing force generated by currents and magnetic poles. For most applications, the magnetic field strength can be thought of as the applied field generated, for example, by a superconducting magnet. The magnetic field strength is not a property of materials. Measure in SI units of A/m or cgs units of oersted.

**magnetic flux density (B).** Also referred to as magnetic induction. This is the net magnetic response of a medium to an applied field, H. The relationship is given by the following equation:  $B = \mu_0(H + M)$  for SI, and  $B = H + 4\pi M$  for cgs, where H = magnetic field strength, M = magnetization, and  $\mu_0$  = permeability of free space =  $4\pi \times 10^{-7}$  H/m.

**magnetic hysteresis.** The property of a magnetic material where the magnetic induction (B) for a given magnetic field strength (H) depends upon the past history of the samples magnetization.

**magnetic induction (B).** *See* magnetic flux density.

**magnetic moment (m).** This is the fundamental magnetic property measured with DC magnetic measurements systems such as a vibrating sample magnetometer, extraction magnetometer, SQUID magnetometer, etc. The exact technical definition relates to the torque exerted on a magnetized sample when placed in a magnetic field. Note that the moment is a total attribute of a sample and alone does not necessarily supply sufficient information in understanding material properties. A small highly magnetic sample can have exactly the same moment as a larger weakly magnetic sample (*see* Magnetization). Measured in SI units as A·m<sup>2</sup> and in cgs units as emu. 1 emu = 10<sup>-3</sup> A·m<sup>2</sup>.

**magnetic units.** Units used in measuring magnetic quantities. Includes ampere-turn, gauss, gilbert, line of force, maxwell, oersted, and unit magnetic pole.

**magnetization (M).** This is a material specific property defined as the magnetic moment (m) per unit volume (V).  $M = m/V$ .

Measured in SI units as A/m and in cgs units as emu/cm<sup>3</sup>. 1 emu/cm<sup>3</sup> = 10<sup>3</sup> A/m. Since the mass of a sample is generally much easier to determine than the volume, magnetization is often alternately expressed as a mass magnetization defined as the moment per unit mass.

**material safety data sheet (MSDS).** OSHA Form 20 contains descriptive information on hazardous chemicals under the OSHA Hazard Communication Standard (HCS). These data sheets also provide precautionary information on the safe handling of the gas as well as emergency and first aid procedures.

**MKSA System of Units.** A system in which the basic units are the meter, kilogram, and second, and the ampere is a derived unit defined by assigning the magnitude  $4\pi \times 10^{-7}$  to the rationalized magnetic constant (sometimes called the permeability of space).

**negative temperature coefficient (NTC).** Refers to the sign of the temperature sensitivity. For example, the resistance of a NTC sensor decreases with increasing temperature.

**National Institute of Standards and Technology (NIST).** Government agency located in Gaithersburg, Maryland and Boulder, Colorado, that defines measurement standards in the United States.

**noise (electrical).** Unwanted electrical signals that produce undesirable effects in circuits of control systems in which they occur.<sup>2</sup>

**normalized sensitivity.** For resistors, signal sensitivity (dR/dT) is geometry dependent; i.e., dR/dT scales directly with R; consequently, very often this sensitivity is normalized by dividing by the measured resistance to give a sensitivity,  $s_T$ , in percent change per kelvin.  $s_T = (100/R) (dR/dT) \%K$ , where T is the temperature in kelvin and R is the resistance in ohms.

**normally closed (N.C.).** A term used for switches and relay contacts. Provides a closed circuit when actuator is in the free (unenergized) position.

**normally open (N.O.).** A term used for switches and relay contacts. Provides an open circuit when actuator is in the free (unenergized) position.

**oersted (Oe).** The cgs unit for the magnetic field strength (H). 1 oersted =  $10^3/4\pi$  ampere/meter  $\approx 79.58$  ampere/meter.

**ohm ( $\Omega$ ).** The SI unit of resistance (and of impedance). The ohm is the resistance of a conductor such that a constant current of one ampere in it produces a voltage of one volt between its ends.<sup>2</sup>

**open-loop.** A control system in which the system outputs are controlled by system inputs only, and no account is taken of actual system output.<sup>1</sup>

**pascal (Pa).** The SI unit of pressure equal to 1 N/m<sup>2</sup>. Equal to  $1.45 \times 10^{-4}$  psi,  $1.0197 \times 10^{-5}$  kg<sub>f</sub>/cm<sup>2</sup>,  $7.5 \times 10^{-3}$  torr,  $4.191 \times 10^{-3}$  inches of water, or  $1 \times 10^{-5}$  bar.

**permeability.** Material parameter which is the ratio of the magnetic induction (B) to the magnetic field strength (H):  $\mu = B/H$ . Also *see* Initial Permeability and Differential Permeability.

**platinum (Pt).** A common temperature sensing material fabricated from pure platinum to make the Lake Shore PT family of resistance temperature sensor elements.

**polynomial fit.** A mathematical equation used to fit calibration data. Polynomials are constructed of finite sums of terms of the form  $a_i x_i$ , where  $a_i$  is the  $i^{\text{th}}$  fit coefficient and  $x_i$  is some function of the dependent variable.

**positive temperature coefficient (PTC).** Refers to the sign of the temperature sensitivity. For example, the resistance of a PTC sensor increases with increasing temperature.

**pounds per square inch (psi).** A unit of pressure. 1 psi = 6.89473 kPa. Variations include psi absolute (psia) measured relative to vacuum (zero pressure) where one atmosphere pressure equals 14.696 psia and psi gauge (psig) where gauge measured relative to atmospheric or some other reference pressure.

**precision.** Careful measurement under controlled conditions that can be repeated with similar results. *See* repeatability. Also means that small differences can be detected and measured with confidence. *See* resolution.

**prefixes.** SI prefixes used throughout this manual are as follows:

Factor	Prefix	Symbol	Factor	Prefix	Symbol
$10^{24}$	yotta	Y	$10^{-1}$	deci	d
$10^{21}$	zetta	Z	$10^{-2}$	centi	c
$10^{18}$	exa	E	$10^{-3}$	milli	m
$10^{15}$	peta	P	$10^{-6}$	micro	$\mu$
$10^{12}$	tera	T	$10^{-9}$	nano	n
$10^9$	giga	G	$10^{-12}$	pico	p
$10^6$	mega	M	$10^{-15}$	femto	f
$10^3$	kilo	k	$10^{-18}$	atto	a
$10^2$	hecto	h	$10^{-21}$	zepto	z
$10^1$	deka	da	$10^{-24}$	yocto	y

**probe.** A long, thin body containing a sensing element that can be inserted into a system in order to make measurements. Typically, the measurement is localized to the region near the tip of the probe.

**proportional, integral, derivative (PID).** A control function where output is related to the error signal in three ways. Proportional (gain) acts on the instantaneous error as a multiplier. Integral (reset) acts on the area of error with respect to time and can eliminate control offset or droop. Derivative (rate) acts on the rate of change in error to dampen the system, reducing overshoot.

**quench.** A condition where the superconducting magnet goes "normal," i.e., becomes non-superconductive. When this happens, the magnet becomes resistive, heat is generated, liquid cryogen is boiled off, and the magnet power supply is shut down due to the sudden increase in current demand.

**relief valve.** A type of pressure relief device which is designed to relieve excessive pressure, and to re-close and reseal to prevent further flow of gas from the cylinder after reseating pressure has been achieved.

**remanence.** The remaining magnetic induction in a magnetic material when the material is first saturated and then the applied field is reduced to zero. The remanence would be the upper limit to values for the remanent induction. Note that no strict convention exists for the use of remanent induction and remanence and in some contexts the two terms may be used interchangeably.

**remanent induction.** The remaining magnetic induction in a magnetic material after an applied field is reduced to zero. Also *see* remanence.

**repeatability.** The closeness of agreement among repeated measurements of the same variable under the same conditions.<sup>2</sup>

**resistance temperature detector (RTD).** Resistive sensors whose electrical resistance is a known function of the temperature, made of, e.g., carbon-glass, germanium, platinum, or rhodium-iron.

**resolution.** The degree to which nearly equal values of a quantity can be discriminated.<sup>2</sup>

**display resolution.** The resolution of the physical display of an instrument. This is not always the same as the measurement resolution of the instrument. Decimal display resolution specified as " $n$  digits" has  $10^n$  possible display values. A resolution of  $n$  and one-half digits has  $2 \times 10^n$  possible values.

**measurement resolution.** The ability of an instrument to resolve a measured quantity. For digital instrumentation this is often defined by the analog to digital converter being used. A  $n$ -bit converter can resolve one part in  $2^n$ . The smallest signal change that can be measured is the full-scale input divided by  $2^n$  for any given range. Resolution should not be confused with accuracy.

**RhFe.** Rhodium-iron. Rhodium alloyed with less than one atomic percent iron is used to make the Lake Shore RF family of sensors. Rhodium-iron is a spin fluctuation alloy that has a significant temperature coefficient of resistance below 20 K where most metals rapidly lose sensitivity.

**root mean square (RMS).** The square root of the time average of the square of a quantity; for a periodic quantity the average is taken over one complete cycle. Also known as effective value.<sup>1</sup>

**room-temperature compensation.** Thermocouples are a differential measurement device. Their signal represents the difference in temperature between their ends. An ice bath is often used to reference the measurement end to 0 °Celsius so most curves are normalized to that temperature. Room-temperature compensation replaces an ice bath by monitoring the temperature of the thermocouple terminals and normalizing the reading mathematically.

**RS-232C.** Bi-directional computer serial interface standard defined by the Electronic Industries Association (EIA). The interface is single-ended and non-addressable.

**Seebeck effect.** The development of a voltage due to differences in temperature between two junctions of dissimilar metals in the same circuit.<sup>1</sup>

**self-heating.** Heating of a device due to dissipation of power resulting from the excitation applied to the device. The output signal from a sensor increases with excitation level, but so does the self-heating and the associated temperature measurement error.

**sensitivity.** The ratio of the response or change induced in the output to a stimulus or change in the input. Temperature sensitivity of a resistance temperature detector is expressed as  $S = dR/dT$ .

**setpoint.** The value selected to be maintained by an automatic controller.<sup>1</sup>

**serial interface.** A computer interface where information is transferred one bit at a time rather than one byte (character) at a time as in a parallel interface. RS-232C is the most common serial interface.

**SI.** Système International d'Unités. *See* International System of Units.

**silicon diode.** Temperature sensor based on the forward voltage drop at constant current through a pn semiconductor junction formed in crystalline silicon.

**SoftCal™.** In Lake Shore instruments, SoftCal™ is used to improve the accuracy of a DT-400 Series silicon diode temperature sensor. This reduces the error between the sensor and the standard Curve 10 used by the instrument to convert input voltage from the diode to a corresponding temperature.

**stability.** The ability of an instrument or sensor to maintain a constant output given a constant input.

**strain relief.** A predetermined amount of slack to relieve tension in component or lead wires. Also called stress relief.

**superconducting magnet.** An electromagnet whose coils are made of a type II superconductor with a high transition temperature and extremely high critical field, such as niobium-tin, Nb<sub>3</sub>Sn; it is capable of generating magnetic fields of 100,000 oersteds and more with no steady power dissipation.<sup>1</sup> *See* electromagnet.

**susceptance.** In electrical terms, susceptance is defined as the reciprocal of reactance and the imaginary part of the complex representation of admittance: [suscept(ibility) + (conduct)ance].

**susceptibility ( $\chi$ ).** Parameter giving an indication of the response of a material to an applied magnetic field. The susceptibility is the ratio of the magnetization (M) to the applied field (H).  $\chi = M/H$ . In both SI units and cgs units the volume susceptibility is a dimensionless parameter. Multiply the cgs susceptibility by  $4\pi$  to yield the SI susceptibility. *See* also Initial Susceptibility and Differential Susceptibility. As in the case of magnetization, the susceptibility is often seen expressed as a mass susceptibility or a molar susceptibility depending upon how M is expressed.

**temperature coefficient, measurement.** The measurement accuracy of an instrument is affected by changes in ambient temperature. The error is specified as an amount of change (usually in percent) for every one degree change in ambient temperature.

**tesla (T).** The SI unit for magnetic flux density (B). 1 tesla =  $10^4$  gauss.

**thermal emf.** An electromotive force arising from a difference in temperature at two points along a circuit, as in the Seebeck effect.<sup>1</sup>

**thermocouple.** A pair of dissimilar conductors so joined at two points that an electromotive force is developed by the thermoelectric effects when the junctions are at different temperatures.<sup>2</sup>

**tolerance.** The range between allowable maximum and minimum values.

**torr.** Unit of pressure. 1 torr  $\approx$  1 mm of mercury. 1 atmosphere = 760 torr.

**two-lead.** Measurement technique where one pair of leads is used for both excitation and measurement of a sensor. This method will not reduce the effect of lead resistance on the measurement.

**unit magnetic pole.** A pole with a strength such that when it is placed 1 cm away from a like pole, the force between the two is 1 dyne.

**volt (V).** The difference of electric potential between two points of a conductor carrying a constant current of one ampere, when the power dissipated between these points is equal to one watt.<sup>2</sup>

**volt-ampere (VA).** The SI unit of apparent power. The volt-ampere is the apparent power at the points of entry of a single-phase, two-wire system when the product of the RMS value in amperes of the current by the RMS value in volts of the voltage is equal to one.<sup>2</sup>

**watt (W).** The SI unit of power. The watt is the power required to do work at the rate of 1 joule per second.<sup>2</sup>

#### References:

- 1 Sybil P. Parker, Editor. *McGraw-Hill Dictionary of Scientific and Technical Terms: Fifth Edition*. New York: McGraw Hill, 1994 (ISBN 0-07-113584-7)
- 2 Christopher J. Booth, Editor. *The New IEEE Standard Dictionary of Electrical and Electronic Terms: IEEE Std 100-1992, Fifth Edition*. New York: Institute of Electrical and Electronics Engineers, 1993 (ISBN 1-55937-240-0)
- 3 Nelson, Robert A. *Guide For Metric Practice*, Page BG7 - 8, Physics Today, Eleventh Annual Buyer's Guide, August 1994 (ISSN 0031-9228 coden PHTOAD)

# APPENDIX B

## TEMPERATURE SCALES

### B1.0 DEFINITION

Temperature is a fundamental unit of measurement that describes the kinetic and potential energies of the atoms and molecules of bodies. When the energies and velocities of the molecules in a body are increased, the temperature is increased whether the body is a solid, liquid, or gas. Thermometers are used to measure temperature. The temperature scale is based on the temperature at which ice, liquid water, and water vapor are all in equilibrium. This temperature is called the triple point of water and is assigned the value 0 °C, 32 °F, and 273.15 K. These three temperature scales are defined as follows:

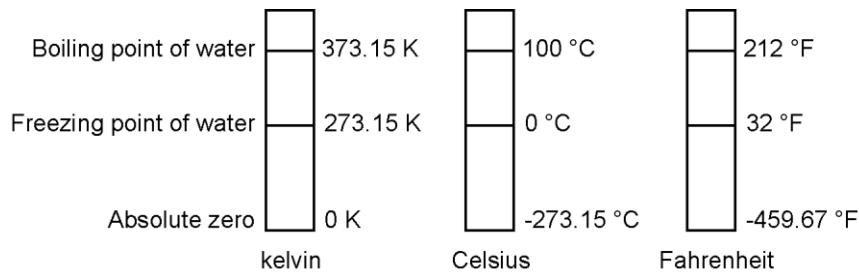
**Celsius.** Abbreviation: °C. A temperature scale that registers the freezing point of water as 0 °C and the boiling point as 100 °C under normal atmospheric pressure. Formerly known as “Centigrade.” Originally devised by Anders Celsius (1701–1744), a Swedish astronomer.

**Fahrenheit.** Abbreviation: °F. A temperature scale that registers the freezing point of water as 32 °F and the boiling point as 212 °F under normal atmospheric pressure. Originally devised by Gabriel Fahrenheit (1686–1736), a German physicist residing in Holland; developed use of mercury in thermometry.

**Kelvin.** Abbreviation: K. An absolute scale of temperature, the zero point of which is approximately –273.15°C. Scale units are equal in magnitude to Celsius degrees. Originally devised by Lord Kelvin, William Thompson, (1824–1907), a British physicist, mathematician, and inventor.

### B2.0 COMPARISON

The three temperature scales are graphically compared in Figure B-1.



**Figure B-1. Temperature Scale Comparison**

### B3.0 CONVERSIONS

To convert Fahrenheit to Celsius: subtract 32 from °F then divide by 1.8, or:

$$^{\circ}\text{C} = (^{\circ}\text{F} - 32) \div 1.8$$

To convert Celsius to Fahrenheit: multiply °C by 1.8 then add 32, or:

$$^{\circ}\text{F} = (1.8 \times ^{\circ}\text{C}) + 32$$

To convert Fahrenheit to kelvin, first convert °F to °C, then add 273.15.

To convert Celsius to kelvin, add 273.15.

**Table B-1. Temperature Conversion Table**

°F	°C	K	°F	°C	K	°F	°C	K
-459.67	-273.15	0	-292	-180	93.15	-129.67	-89.82	183.33
-454	-270	3.15	-290	-178.89	94.26	-120	-84.44	188.71
-450	-267.78	5.37	-289.67	-178.71	94.44	-119.67	-84.26	188.89
-449.67	-267.59	5.56	-280	-173.33	99.82	-117.67	-83.15	190
-441.67	-263.15	10	-279.67	-173.15	100	-112	-80	193.15
-440	-262.22	10.93	-274	-170	103.15	-110	-78.89	194.26
-439.67	-262.04	11.11	-270	-167.78	105.57	-109.67	-78.71	194.44
-436	-260	13.15	-269.67	-167.59	105.56	-100	-73.33	199.82
-430	-256.67	16.48	-261.67	-163.15	110	-99.67	-73.15	200
-429.67	-256.48	16.67	-260	-162.22	110.93	-94	-70	203.15
-423.67	-253.15	20	-259.67	-162.04	111.11	-90	-67.78	205.37
-420	-251.11	22.04	-256	-160	113.15	-89.67	-67.59	205.56
-419.67	-250.93	22.22	-250	-156.67	116.48	-81.67	-63.15	210
-418.00	-250	23.15	-249.67	-156.48	116.67	-80	-62.22	210.93
-410	-245.56	27.59	-243.67	-153.15	120	-79.67	-62.04	211.11
-409.67	-245.37	27.78	-240	-151.11	122.04	-76	-60	213.15
-405.67	-243.15	30	-239.67	-150.93	122.22	-70	-56.67	216.48
-400	-240	33.15	-238	-150	123.15	-69.67	-56.48	216.67
-399.67	-239.82	33.33	-230	-145.56	127.59	-63.67	-53.15	220
-390	-234.44	38.71	-229.67	-145.37	127.78	-60	-51.11	222.04
-389.67	-234.26	38.89	-225.67	-143.15	130	-59.67	-50.93	222.22
-387.67	-233.15	40	-220	-140	133.15	-58	-50	223.15
-382	-230	43.15	-219.67	-139.82	133.33	-50	-45.56	227.59
-380	-228.89	44.26	-210	-134.44	138.71	-49.67	-45.37	227.78
-379.67	-228.71	44.44	-209.67	-134.26	138.89	-45.67	-43.15	230
-370	-223.33	49.82	-207.67	-133.15	140	-40	-40	233.15
369.67	-223.15	50	-202	-130	143.15	-39.67	-39.82	233.33
-364	-220	53.15	-200	-128.89	144.26	-30	-34.44	238.71
-360	-217.78	55.37	-199.67	-128.71	144.44	-29.67	-34.26	238.89
-359.67	-217.59	55.56	-190	-123.33	149.82	-27.67	-33.15	240
-351.67	-213.15	60	189.67	-123.15	150	-22	-30	243.15
-350	-212.22	60.93	-184	-120	153.15	-20	-28.89	244.26
-349.67	-212.04	61.11	-180	-117.78	155.37	-19.67	-28.71	244.44
-346	-210	63.15	-179.67	-117.59	155.56	-10	-23.33	249.82
-340	-206.67	66.48	-171.67	-113.15	160	-9.67	-23.15	250
-339.67	-206.48	66.67	-170	-112.22	160.93	-4	-20	253.15
-333.67	-203.15	70	-169.67	-112.04	161.11	0	-17.78	255.37
-330	-201.11	72.04	-166	-110	163.15	+0.33	-17.59	255.56
-329.67	-200.93	72.22	-160	-106.67	166.48	8.33	-13.15	260
-328	-200	73.15	-159.67	-106.48	166.67	10	-12.22	260.93
-320	-195.56	77.59	-153.67	103.15	170	10.33	-12.04	261.11
-319.67	-195.37	77.78	-150	-101.11	172.04	14	-10	263.15
-315.67	-193.15	80	-149.67	-100.93	172.22	20	-6.67	266.48
-310	-190	83.15	-148	-100	173.15	20.33	-6.48	266.67
-309.67	-189.82	83.33	-140	-95.96	177.59	26.33	-3.15	270
-300	-184.44	88.71	-139.67	-95.37	177.78	30	-1.11	272.04
-299.67	-184.26	88.89	-135.67	-93.15	180	30.33	-0.93	272.22
-297.67	-183.15	90	-130	-90	183.15	32	0	273.15

# APPENDIX C

## HANDLING LIQUID HELIUM AND NITROGEN

### C1.0 GENERAL

Use of liquid helium (LHe) and liquid nitrogen (LN<sub>2</sub>) is often associated with the Model 325 temperature controller. Although not explosive, there are a number of safety considerations to keep in mind in the handling of LHe and LN<sub>2</sub>.

### C2.0 PROPERTIES

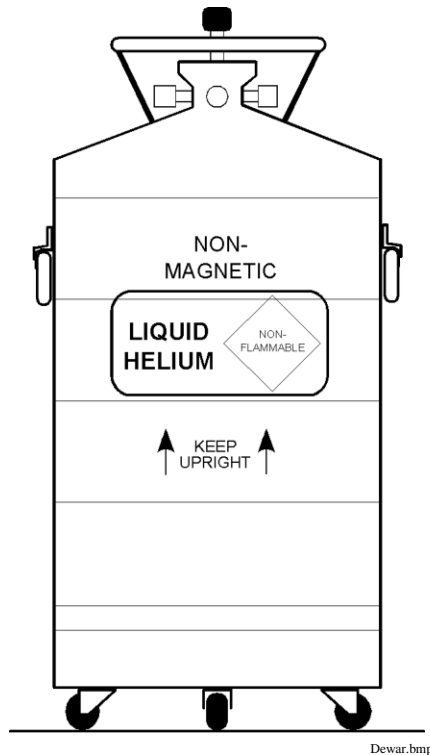
LHe and LN<sub>2</sub> are colorless, odorless, and tasteless gases. Gaseous nitrogen makes up about 78 percent of the Earth's atmosphere, while helium comprises only about 5 ppm. Most helium is recovered from natural gas deposits. Once collected and isolated, the gases will liquefy when properly cooled. A quick comparison between LHe and LN<sub>2</sub> is provided in Table C-1.

**Table C-1. Comparison of Liquid Helium and Liquid Nitrogen**

PROPERTY	LIQUID HELIUM	LIQUID NITROGEN
Boiling Point at 1 atm, in K	4.2	77
Thermal Conductivity (Gas), w/cm-K	0.083	0.013
Latent Heat of Vaporization, Btu/L	2.4	152
Liquid Density, lb/L	0.275	0.78

### C3.0 HANDLING CRYOGENIC STORAGE DEWARs

Cryogenic containers (Dewars) must be operated in accordance with the manufacturer instructions. Safety instructions will also be posted on the side of each Dewar. Cryogenic Dewars must be kept in a well-ventilated place where they are protected from the weather and away from any sources of heat. A typical cryogenic Dewar is shown in Figure C-1.



**Figure C-1. Typical Cryogenic Storage Dewar**

#### **C4.0 LIQUID HELIUM AND NITROGEN SAFETY PRECAUTIONS**

Transferring LHe and LN<sub>2</sub> and operation of the storage Dewar controls should be in accordance with the manufacturer/supplier's instructions. During this transfer, it is important that all safety precautions written on the storage Dewar and recommended by the manufacturer be followed.

**WARNING:** Liquid helium and liquid nitrogen are potential asphyxiants and can cause rapid suffocation without warning. Store and use in area with adequate ventilation. DO NOT vent container in confined spaces. DO NOT enter confined spaces where gas may be present unless area has been well ventilated. If inhaled, remove to fresh air. If not breathing, give artificial respiration. If breathing is difficult, give oxygen. Get medical help.

**WARNING:** Liquid helium and liquid nitrogen can cause severe frostbite to the eyes or skin. DO NOT touch frosted pipes or valves. In case of frostbite, consult a physician at once. If a physician is not readily available, warm the affected areas with water that is near body temperature.

The two most important safety aspects to consider when handling LHe and LN<sub>2</sub> are adequate ventilation and eye and skin protection. Although helium and nitrogen gases are non-toxic, they are dangerous in that they replace the air in a normal breathing atmosphere. Liquid products are of an even greater threat since a small amount of liquid evaporates to create a large amount of gas. Therefore, it is imperative that cryogenic Dewars be stored and the MTD system be operated in open and well ventilated areas.

Persons transferring LHe and LN<sub>2</sub> should make every effort to protect eyes and skin from accidental contact with liquid or the cold gas issuing from it. Protect your eyes with full-face shield or chemical splash goggles. Safety glasses (even with side shields) are not adequate. Always wear special cryogenic gloves (Tempshield Cryo-Gloves® or equivalent) when handling anything that is, or may have been, in contact with the liquid or cold gas, or with cold pipes or equipment. Long sleeve shirts and cuffless trousers that are of sufficient length to prevent liquid from entering the shoes are recommended.

#### **C5.0 RECOMMENDED FIRST AID**

Every site that stores and uses LHe and LN<sub>2</sub> should have an appropriate Material Safety Data Sheet (MSDS) present. The MSDS may be obtained from the manufacturer/distributor. The MSDS will specify the symptoms of overexposure and the first aid to be used. A typical summary of these instructions is provided as follows.

If symptoms of asphyxia such as headache, drowsiness, dizziness, excitation, excess salivation, vomiting, or unconsciousness are observed, remove the victim to fresh air. If breathing is difficult, give oxygen. If breathing has stopped, give artificial respiration. Call a physician immediately.

If exposure to cryogenic liquids or cold gases occurs, restore tissue to normal body temperature (98.6 °F) as rapidly as possible, then protect the injured tissue from further damage and infection. Call a physician immediately. Rapid warming of the affected parts is best achieved by bathing it in warm water. The water temperature should not exceed 105 °F (40 °C), and under no circumstances should the frozen part be rubbed, either before or after rewarming. If the eyes are involved, flush them thoroughly with warm water for at least 15 minutes. In case of massive exposure, remove clothing while showering with warm water. The patient should not drink alcohol or smoke. Keep warm and rest. Call a physician immediately.



# APPENDIX D

## CURVE TABLES

### D1.0 GENERAL

Standard curve tables included in the Model 325 temperature controller are as follows:

Curve 01	DT-470 Silicon Diode.....	Table D-1
Curve 02	DT-670 Silicon Diode.....	Table D-2
Curve 03 & 04	DT-500-D/-E1 Silicon Diode.....	Table D-3
Curve 06 & 07	PT-100/-1000 Platinum RTD.....	Table D-4
Curve 08	RX-102A Rox™.....	Table D-5
Curve 09	RX-202A Rox™.....	Table D-6
Curve 12	Type K Thermocouple.....	Table D-7
Curve 13	Type E Thermocouple.....	Table D-8
Curve 14	Type T Thermocouple.....	Table D-9
Curve 15	Chromel-AuFe 0.03% Thermocouple.....	Table D-10
Curve 16	Chromel-AuFe 0.07% Thermocouple.....	Table D-11

**Table D-1. Lake Shore DT-470 Silicon Diode (Curve 10)**

Break-point	Temp. (K)	Volts	Break-point	Temp. (K)	Volts	Break-point	Temp. (K)	Volts
1	475.0	0.09062	30	170.0	0.82405	59	031.0	1.10476
2	470.0	0.10191	31	160.0	0.84651	60	030.0	1.10702
3	465.0	0.11356	32	150.0	0.86874	61	029.0	1.10945
4	460.0	0.12547	33	145.0	0.87976	62	028.0	1.11212
5	455.0	0.13759	34	140.0	0.89072	63	027.0	1.11517
6	450.0	0.14985	35	135.0	0.90161	64	026.0	1.11896
7	445.0	0.16221	36	130.0	0.91243	65	025.0	1.12463
8	440.0	0.17464	37	125.0	0.92317	66	024.0	1.13598
9	435.0	0.18710	38	120.0	0.93383	67	023.0	1.15558
10	430.0	0.19961	39	115.0	0.94440	68	022.0	1.17705
11	420.0	0.22463	40	110.0	0.95487	69	021.0	1.19645
12	410.0	0.24964	41	105.0	0.96524	70	019.5	1.22321
13	400.0	0.27456	42	100.0	0.97550	71	017.0	1.26685
14	395.0	0.28701	43	095.0	0.98564	72	015.0	1.30404
15	380.0	0.32417	44	090.0	0.99565	73	013.5	1.33438
16	365.0	0.36111	45	085.0	1.00552	74	012.5	1.35642
17	345.0	0.41005	46	080.0	1.01525	75	011.5	1.38012
18	330.0	0.44647	47	075.0	1.02482	76	010.5	1.40605
19	325.0	0.45860	48	070.0	1.03425	77	009.5	1.43474
20	305.0	0.50691	49	065.0	1.04353	78	008.5	1.46684
21	300.0	0.51892	50	058.0	1.05630	79	007.5	1.50258
22	285.0	0.55494	51	052.0	1.06702	80	005.2	1.59075
23	265.0	0.60275	52	046.0	1.07750	81	004.2	1.62622
24	250.0	0.63842	53	040.0	1.08781	82	003.4	1.65156
25	235.0	0.67389	54	039.0	1.08953	83	002.6	1.67398
26	220.0	0.70909	55	036.0	1.09489	84	002.1	1.68585
27	205.0	0.74400	56	034.0	1.09864	85	001.7	1.69367
28	190.0	0.77857	57	033.0	1.10060	86	001.4	1.69818
29	180.0	0.80139	58	032.0	1.10263			

**Table D-2. Standard DT-670 Diode Curve**

Breakpoint	V	Temp. (K)	Breakpoint	V	Temp. (K)	Breakpoint	V	Temp. (K)
1	0.090570	500.0	26	1.01064	87.0	51	1.19475	20.2
2	0.110239	491.0	27	1.02125	81.0	52	1.24208	17.10
3	0.136555	479.5	28	1.03167	75.0	53	1.26122	15.90
4	0.179181	461.5	29	1.04189	69.0	54	1.27811	14.90
5	0.265393	425.5	30	1.05192	63.0	55	1.29430	14.00
6	0.349522	390.0	31	1.06277	56.4	56	1.31070	13.15
7	0.452797	346.0	32	1.07472	49.0	57	1.32727	12.35
8	0.513393	320.0	33	1.09110	38.7	58	1.34506	11.55
9	0.563128	298.5	34	1.09602	35.7	59	1.36423	10.75
10	0.607845	279.0	35	1.10014	33.3	60	1.38361	10.00
11	0.648723	261.0	36	1.10393	31.2	61	1.40454	9.25
12	0.686936	244.0	37	1.10702	29.6	62	1.42732	8.50
13	0.722511	228.0	38	1.10974	28.3	63	1.45206	7.75
14	0.755487	213.0	39	1.11204	27.3	64	1.48578	6.80
15	0.786992	198.5	40	1.11414	26.5	65	1.53523	5.46
16	0.817025	184.5	41	1.11628	25.8	66	1.56684	4.56
17	0.844538	171.5	42	1.11853	25.2	67	1.58358	4.04
18	0.869583	159.5	43	1.12090	24.7	68	1.59690	3.58
19	0.893230	148.0	44	1.12340	24.3	69	1.60756	3.18
20	0.914469	137.5	45	1.12589	24.0	70	1.62125	2.62
21	0.934356	127.5	46	1.12913	23.7	71	1.62945	2.26
22	0.952903	118.0	47	1.13494	23.3	72	1.63516	1.98
23	0.970134	109.0	48	1.14495	22.8	73	1.63943	1.74
24	0.986073	100.5	49	1.16297	22.0	74	1.64261	1.53
25	0.998925	93.5	50	1.17651	21.3	75	1.64430	1.40

**Table D-3. Lake Shore DT-500 Series Silicon Diode Curves (No longer in production)**

Breakpoint	DT-500-D Curve		DT-500-E1 Curve	
	Temp. (K)	Volts	Temp. (K)	Volts
1	365.0	0.19083	330.0	0.28930
2	345.0	0.24739	305.0	0.36220
3	305.0	0.36397	285.0	0.41860
4	285.0	0.42019	265.0	0.47220
5	265.0	0.47403	240.0	0.53770
6	240.0	0.53960	220.0	0.59260
7	220.0	0.59455	170.0	0.73440
8	170.0	0.73582	130.0	0.84490
9	130.0	0.84606	100.0	0.92570
10	090.0	0.95327	075.0	0.99110
11	070.0	1.00460	060.0	1.02840
12	055.0	1.04070	040.0	1.07460
13	040.0	1.07460	036.0	1.08480
14	034.0	1.09020	034.0	1.09090
15	032.0	1.09700	032.0	1.09810
16	030.0	1.10580	030.0	1.10800
17	029.0	1.11160	029.0	1.11500
18	028.0	1.11900	028.0	1.12390
19	027.0	1.13080	027.0	1.13650
20	026.0	1.14860	026.0	1.15590
21	025.0	1.17200	025.0	1.18770
22	023.0	1.25070	024.0	1.23570
23	021.0	1.35050	022.0	1.32570
24	017.0	1.63590	018.0	1.65270
25	015.0	1.76100	013.0	1.96320
26	013.0	1.90660	009.0	2.17840
27	009.0	2.11720	004.0	2.53640
28	003.0	2.53660	003.0	2.59940
29	001.4	2.59840	001.4	2.65910

Table D-4. Lake Shore PT-100/1000 Platinum RTD Curves

Break-point	PT-100		PT-1000	
	Temp. (K)	Ohms ( $\Omega$ )	Temp. (K)	Ohms ( $\Omega$ )
1	030.0	3.820	030.0	38.20
2	032.0	4.235	032.0	42.35
3	036.0	5.146	036.0	51.46
4	038.0	5.650	038.0	56.50
5	040.0	6.170	040.0	61.70
6	042.0	6.726	042.0	67.26
7	046.0	7.909	046.0	79.09
8	052.0	9.924	052.0	99.24
9	058.0	12.180	058.0	121.80
10	065.0	15.015	065.0	150.15
11	075.0	19.223	075.0	192.23
12	085.0	23.525	085.0	235.25
13	105.0	32.081	105.0	320.81
14	140.0	46.648	140.0	466.48
15	180.0	62.980	180.0	629.80
16	210.0	75.044	210.0	750.44
17	270.0	98.784	270.0	987.84
18	315.0	116.270	315.0	1162.70
19	355.0	131.616	355.0	1316.16
20	400.0	148.652	400.0	1486.52
21	445.0	165.466	445.0	1654.66
22	490.0	182.035	490.0	1820.35
23	535.0	198.386	535.0	1983.86
24	585.0	216.256	585.0	2162.56
25	630.0	232.106	630.0	2321.06
26	675.0	247.712	675.0	2477.12
27	715.0	261.391	715.0	2613.91
28	760.0	276.566	760.0	2765.66
29	800.0	289.830	800.0	2898.30

Table D-5. Lake Shore RX-102A Rox™ Curve

Break-point	logΩ	Temp. (K)	Break-point	logΩ	Temp. (K)	Break-point	logΩ	Temp. (K)
1	3.02081	40.0	36	3.05186	13.50	71	3.17838	2.96
2	3.02133	38.8	37	3.05322	13.10	72	3.18540	2.81
3	3.02184	37.7	38	3.05466	12.70	73	3.19253	2.67
4	3.02237	36.6	39	3.05618	12.30	74	3.20027	2.53
5	3.02294	35.5	40	3.05780	11.90	75	3.20875	2.39
6	3.02353	34.4	41	3.05952	11.50	76	3.21736	2.26
7	3.02411	33.4	42	3.06135	11.10	77	3.22675	2.13
8	3.02472	32.4	43	3.06330	10.70	78	3.23707	2.00
9	3.02537	31.4	44	3.06537	10.30	79	3.24842	1.87
10	3.02605	30.4	45	3.06760	9.90	80	3.26000	1.75
11	3.02679	29.4	46	3.06968	9.55	81	3.27169	1.64
12	3.02749	28.5	47	3.07190	9.20	82	3.28462	1.53
13	3.02823	27.6	48	3.07428	8.85	83	3.29779	1.43
14	3.02903	26.7	49	3.07685	8.50	84	3.31256	1.33
15	3.02988	25.8	50	3.07922	8.20	85	3.32938	1.23
16	3.03078	24.9	51	3.08175	7.90	86	3.34846	1.130
17	3.03176	24.0	52	3.08447	7.60	87	3.37196	1.020
18	3.03280	23.1	53	3.08786	7.25	88	3.39220	0.935
19	3.03393	22.2	54	3.09150	6.90	89	3.41621	0.850
20	3.03500	21.4	55	3.09485	6.60	90	3.44351	0.765
21	3.03615	20.6	56	3.09791	6.35	91	3.47148	0.690
22	3.03716	19.95	57	3.10191	6.05	92	3.50420	0.615
23	3.03797	19.45	58	3.10638	5.74	93	3.54057	0.545
24	3.03882	18.95	59	3.11078	5.46	94	3.58493	0.474
25	3.03971	18.45	60	3.11558	5.18	95	3.63222	0.412
26	3.04065	17.95	61	3.12085	4.90	96	3.68615	0.354
27	3.04164	17.45	62	3.12622	4.64	97	3.75456	0.295
28	3.04258	17.00	63	3.13211	4.38	98	3.82865	0.245
29	3.04357	16.55	64	3.13861	4.12	99	3.91348	0.201
30	3.04460	16.10	65	3.14411	3.92	100	4.01514	0.162
31	3.04569	15.65	66	3.14913	3.75	101	4.14432	0.127
32	3.04685	15.20	67	3.15454	3.58	102	4.34126	0.091
33	3.04807	14.75	68	3.16002	3.42	103	4.54568	0.066
34	3.04936	14.30	69	3.16593	3.26	104	4.79803	0.050
35	3.05058	13.90	70	3.17191	3.11			

Table D-6. Lake Shore RX-202A Rox™ Curve

Break-point	logΩ	Temp. (K)	Break-point	logΩ	Temp. (K)	Break-point	logΩ	Temp. (K)
1	3.35085	40.0	34	3.40482	11.45	67	3.52772	2.17
2	3.35222	38.5	35	3.40688	11.00	68	3.53459	2.04
3	3.35346	37.2	36	3.40905	10.55	69	3.54157	1.92
4	3.35476	35.9	37	3.41134	10.10	70	3.54923	1.80
5	3.35612	34.6	38	3.41377	9.65	71	3.55775	1.68
6	3.35755	33.3	39	3.41606	9.25	72	3.56646	1.57
7	3.35894	32.1	40	3.41848	8.85	73	3.57616	1.46
8	3.36039	30.9	41	3.42105	8.45	74	3.58708	1.35
9	3.36192	29.7	42	3.42380	8.05	75	3.59830	1.25
10	3.36340	28.6	43	3.42637	7.70	76	3.61092	1.150
11	3.36495	27.5	44	3.42910	7.35	77	3.62451	1.055
12	3.36659	26.4	45	3.43202	7.00	78	3.63912	0.965
13	3.36831	25.3	46	3.43515	6.65	79	3.65489	0.880
14	3.37014	24.2	47	3.43853	6.30	80	3.67206	0.800
15	3.37191	23.2	48	3.44230	5.94	81	3.69095	0.725
16	3.37377	22.2	49	3.44593	5.62	82	3.71460	0.645
17	3.37575	21.2	50	3.44984	5.30	83	3.73889	0.575
18	3.37785	20.2	51	3.45355	5.02	84	3.76599	0.510
19	3.37942	19.50	52	3.45734	4.76	85	3.79703	0.448
20	3.38081	18.90	53	3.46180	4.48	86	3.83269	0.390
21	3.38226	18.30	54	3.46632	4.22	87	3.87369	0.336
22	3.38377	17.70	55	3.47012	4.02	88	3.92642	0.281
23	3.38522	17.15	56	3.47357	3.85	89	3.98609	0.233
24	3.38672	16.60	57	3.47726	3.68	90	4.05672	0.190
25	3.38829	16.05	58	3.48122	3.51	91	4.14042	0.153
26	3.38993	15.50	59	3.48524	3.35	92	4.24807	0.120
27	3.39165	14.95	60	3.48955	3.19	93	4.40832	0.088
28	3.39345	14.40	61	3.49421	3.03	94	4.57858	0.067
29	3.39516	13.90	62	3.49894	2.88	95	4.76196	0.055
30	3.39695	13.40	63	3.50406	2.73	96	4.79575	0.051
31	3.39882	12.90	64	3.50962	2.58	97	4.81870	0.050
32	3.40079	12.40	65	3.51528	2.44			
33	3.40286	11.90	66	3.52145	2.30			

Table D-7. Type K (Nickel-Chromium vs. Nickel-Aluminum) Thermocouple Curve

Break-point	mV	Temp (K)	Break-point	mV	Temp (K)	Break-point	mV	Temp (K)	Break-point	mV	Temp (K)
1	-6.45774	3.15	48	-6.10828	57.4	95	-2.95792	192	142	18.1482	714.5
2	-6.45733	3.68	49	-6.08343	59.4	96	-2.82629	196	143	19.2959	741.5
3	-6.45688	4.2	50	-6.05645	61.5	97	-2.6762	200.5	144	20.8082	777
4	-6.45632	4.78	51	-6.02997	63.5	98	-2.52392	205	145	23.1752	832.5
5	-6.45565	5.4	52	-6.00271	65.5	99	-2.36961	209.5	146	24.5166	864
6	-6.45494	6	53	-5.97469	67.5	100	-2.21329	214	147	25.6001	889.5
7	-6.4541	6.65	54	-5.94591	69.5	101	-2.05503	218.5	148	26.5536	912
8	-6.4531	7.35	55	-5.91637	71.5	102	-1.87703	223.5	149	27.4199	932.5
9	-6.45201	8.05	56	-5.8861	73.5	103	-1.69672	228.5	150	28.2413	952
10	-6.45073	8.8	57	-5.85508	75.5	104	-1.51427	233.5	151	29.0181	970.5
11	-6.44934	9.55	58	-5.82334	77.5	105	-1.32972	238.5	152	29.7714	988.5
12	-6.44774	10.35	59	-5.78268	80	106	-1.12444	244	153	30.5011	1006
13	-6.44601	11.15	60	-5.74084	82.5	107	-0.91675	249.5	154	31.2074	1023
14	-6.44403	12	61	-5.69792	85	108	-0.70686	255	155	31.8905	1039.5
15	-6.44189	12.85	62	-5.6539	87.5	109	-0.47553	261	156	32.571	1056
16	-6.43947	13.75	63	-5.60879	90	110	-0.22228	267.5	157	33.2489	1072.5
17	-6.43672	14.7	64	-5.5626	92.5	111	0.053112	274.5	158	33.9038	1088.5
18	-6.43378	15.65	65	-5.51535	95	112	0.350783	282	159	34.5561	1104.5
19	-6.43065	16.6	66	-5.46705	97.5	113	0.651006	289.5	160	35.2059	1120.5
20	-6.42714	17.6	67	-5.4177	100	114	0.973714	297.5	161	35.8532	1136.5
21	-6.42321	18.65	68	-5.36731	102.5	115	1.31919	306	162	36.4979	1152.5
22	-6.41905	19.7	69	-5.3159	105	116	1.70801	315.5	163	37.14	1168.5
23	-6.41442	20.8	70	-5.26348	107.5	117	2.14052	326	164	37.7596	1184
24	-6.40952	21.9	71	-5.19928	110.5	118	2.69954	339.5	165	38.3767	1199.5
25	-6.40435	23	72	-5.13359	113.5	119	3.75883	365	166	38.9915	1215
26	-6.39841	24.2	73	-5.06651	116.5	120	4.29687	378	167	39.6038	1230.5
27	-6.39214	25.4	74	-4.99801	119.5	121	4.74986	389	168	40.2136	1246
28	-6.38554	26.6	75	-4.92813	122.5	122	5.17977	399.5	169	40.821	1261.5
29	-6.37863	27.8	76	-4.85687	125.5	123	5.60705	410	170	41.4063	1276.5
30	-6.37077	29.1	77	-4.78426	128.5	124	6.03172	420.5	171	41.9893	1291.5
31	-6.36253	30.4	78	-4.71031	131.5	125	6.49428	432	172	42.5699	1306.5
32	-6.35391	31.7	79	-4.63503	134.5	126	7.09465	447	173	43.1288	1321
33	-6.34422	33.1	80	-4.55845	137.5	127	8.15226	473.5	174	43.6853	1335.5
34	-6.33408	34.5	81	-4.48056	140.5	128	8.75291	488.5	175	44.2394	1350
35	-6.3235	35.9	82	-4.38814	144	129	9.25576	501	176	44.7721	1364
36	-6.3117	37.4	83	-4.29393	147.5	130	9.74087	513	177	45.3024	1378
37	-6.29939	38.9	84	-4.19806	151	131	10.2285	525	178	45.8114	1391.5
38	-6.2866	40.4	85	-4.10051	154.5	132	10.7186	537	179	46.3182	1405
39	-6.27241	42	86	-4.00133	158	133	11.2317	549.5	180	46.8038	1418
40	-6.25768	43.6	87	-3.90053	161.5	134	11.7883	563	181	47.2873	1431
41	-6.24239	45.2	88	-3.79815	165	135	12.3888	577.5	182	47.7684	1444
42	-6.22656	46.8	89	-3.6942	168.5	136	13.054	593.5	183	48.2287	1456.5
43	-6.21019	48.4	90	-3.58873	172	137	13.7844	611	184	48.6868	1469
44	-6.19115	50.2	91	-3.46638	176	138	14.5592	629.5	185	49.1426	1481.5
45	-6.17142	52	92	-3.34204	180	139	15.3786	649	186	49.5779	1493.5
46	-6.15103	53.8	93	-3.21584	184	140	16.2428	669.5	187	50.0111	1505.5
47	-6.12998	55.6	94	-3.08778	188	141	17.1518	691			

Table D-8. Type E (Nickel-Chromium vs. Copper-Nickel) Thermocouple Curve

Break-point	mV	Temp (K)	Break-point	mV	Temp (K)	Break-point	mV	Temp (K)
1	-9.834960	3.15	55	-8.713010	77.50	109	0.701295	285.00
2	-9.834220	3.59	56	-8.646710	80.00	110	1.061410	291.00
3	-9.833370	4.04	57	-8.578890	82.50	111	1.424820	297.00
4	-9.832260	4.56	58	-8.509590	85.00	112	1.791560	303.00
5	-9.830920	5.12	59	-8.438800	87.50	113	2.161610	309.00
6	-9.829330	5.72	60	-8.366570	90.00	114	2.534960	315.00
7	-9.827470	6.35	61	-8.292900	92.50	115	2.943070	321.50
8	-9.825370	7.00	62	-8.217810	95.00	116	3.355100	328.00
9	-9.822890	7.70	63	-8.141330	97.50	117	3.770870	334.50
10	-9.820010	8.45	64	-8.047780	100.50	118	4.190420	341.00
11	-9.816880	9.20	65	-7.952190	103.50	119	4.613650	347.50
12	-9.813290	10.00	66	-7.854690	106.50	120	5.040520	354.00
13	-9.809180	10.85	67	-7.755260	109.50	121	5.470960	360.50
14	-9.804510	11.75	68	-7.653960	112.50	122	5.938380	367.50
15	-9.799510	12.65	69	-7.550790	115.50	123	6.409870	374.50
16	-9.793900	13.60	70	-7.445790	118.50	124	6.885210	381.50
17	-9.787610	14.60	71	-7.338970	121.50	125	7.364360	388.50
18	-9.780590	15.65	72	-7.230370	124.50	126	7.881760	396.00
19	-9.773150	16.70	73	-7.120010	127.50	127	8.403380	403.50
20	-9.764910	17.80	74	-6.989110	131.00	128	8.928940	411.00
21	-9.755820	18.95	75	-6.855790	134.50	129	9.493760	419.00
22	-9.746230	20.10	76	-6.720200	138.00	130	10.0629	427.00
23	-9.735700	21.30	77	-6.582330	141.50	131	10.6361	435.00
24	-9.724650	22.50	78	-6.442220	145.00	132	11.2494	443.50
25	-9.713080	23.70	79	-6.299900	148.50	133	11.867	452.00
26	-9.699960	25.00	80	-6.155400	152.00	134	12.5253	461.00
27	-9.686220	26.30	81	-6.008740	155.50	135	13.188	470.00
28	-9.671890	27.60	82	-5.859960	159.00	136	13.892	479.50
29	-9.655790	29.00	83	-5.687430	163.00	137	14.6005	489.00
30	-9.638980	30.40	84	-5.512090	167.00	138	15.3507	499.00
31	-9.621500	31.80	85	-5.334130	171.00	139	16.1432	509.50
32	-9.602020	33.30	86	-5.153520	175.00	140	16.9403	520.00
33	-9.581740	34.80	87	-4.970330	179.00	141	17.7798	531.00
34	-9.560710	36.30	88	-4.784590	183.00	142	18.6624	542.50
35	-9.537440	37.90	89	-4.596330	187.00	143	19.5881	554.50
36	-9.513290	39.50	90	-4.405600	191.00	144	20.5573	567.00
37	-9.486720	41.20	91	-4.212440	195.00	145	21.5702	580.00
38	-9.457560	43.00	92	-3.992330	199.50	146	22.627	593.50
39	-9.427340	44.80	93	-3.769140	204.00	147	23.7279	607.50
40	-9.396080	46.60	94	-3.543070	208.50	148	24.873	622.00
41	-9.363810	48.40	95	-3.314120	213.00	149	26.0623	637.00
42	-9.330540	50.20	96	-3.082340	217.50	150	27.3356	653.00
43	-9.296270	52.00	97	-2.847790	222.00	151	28.6935	670.00
44	-9.257090	54.00	98	-2.610520	226.50	152	30.1761	688.50
45	-9.216690	56.00	99	-2.343820	231.50	153	31.8242	709.00
46	-9.175140	58.00	100	-2.073770	236.50	154	33.7187	732.50
47	-9.132450	60.00	101	-1.800570	241.50	155	36.1028	762.00
48	-9.088620	62.00	102	-1.524210	246.50	156	41.8502	833.00
49	-9.043710	64.00	103	-1.244740	251.50	157	44.2747	863.00
50	-8.997710	66.00	104	-0.962207	256.50	158	46.2907	888.00
51	-8.950650	68.00	105	-0.676647	261.50	159	48.1007	910.50
52	-8.902530	70.00	106	-0.359204	267.00	160	49.8256	932.00
53	-8.840980	72.50	107	-0.009079	273.00	161	51.5056	953.00
54	-8.777760	75.00	108	0.344505	279.00			

Table D-9. Type T (Copper vs. Copper-Nickel) Thermocouple Curve

Break-point	mV	Temp (K)	Break-point	mV	Temp (K)	Break-point	mV	Temp (K)
1	-6.257510	3.15	56	-5.424100	84.00	111	0.623032	289.00
2	-6.257060	3.56	57	-5.380600	86.50	112	0.843856	294.50
3	-6.256520	4.00	58	-5.336260	89.00	113	1.067190	300.00
4	-6.255810	4.50	59	-5.291080	91.50	114	1.293090	305.50
5	-6.254950	5.04	60	-5.245070	94.00	115	1.521570	311.00
6	-6.253920	5.62	61	-5.188800	97.00	116	1.752660	316.50
7	-6.252780	6.20	62	-5.131290	100.00	117	1.986340	322.00
8	-6.251380	6.85	63	-5.072630	103.00	118	2.222600	327.50
9	-6.249730	7.55	64	-5.012780	106.00	119	2.461410	333.00
10	-6.247810	8.30	65	-4.951770	109.00	120	2.702740	338.50
11	-6.245590	9.10	66	-4.889610	112.00	121	2.946550	344.00
12	-6.243040	9.95	67	-4.826300	115.00	122	3.192800	349.50
13	-6.240300	10.80	68	-4.761840	118.00	123	3.441440	355.00
14	-6.237210	11.70	69	-4.696250	121.00	124	3.715300	361.00
15	-6.233710	12.65	70	-4.629530	124.00	125	3.991980	367.00
16	-6.229800	13.65	71	-4.561670	127.00	126	4.271300	373.00
17	-6.225630	14.65	72	-4.492700	130.00	127	4.553250	379.00
18	-6.221000	15.70	73	-4.422610	133.00	128	4.837770	385.00
19	-6.215860	16.80	74	-4.351390	136.00	129	5.148790	391.50
20	-6.210430	17.90	75	-4.266950	139.50	130	5.462770	398.00
21	-6.204430	19.05	76	-4.180930	143.00	131	5.779560	404.50
22	-6.198680	20.10	77	-4.093440	146.50	132	6.099160	411.00
23	-6.191780	21.30	78	-4.004430	150.00	133	6.421500	417.50
24	-6.184530	22.50	79	-3.913940	153.50	134	6.746540	424.00
25	-6.176930	23.70	80	-3.821970	157.00	135	7.099510	431.00
26	-6.168310	25.00	81	-3.728520	160.50	136	7.455590	438.00
27	-6.159280	26.30	82	-3.633620	164.00	137	7.814630	445.00
28	-6.149830	27.60	83	-3.537260	167.50	138	8.176630	452.00
29	-6.139220	29.00	84	-3.439460	171.00	139	8.541540	459.00
30	-6.128130	30.40	85	-3.340240	174.50	140	8.909320	466.00
31	-6.116580	31.80	86	-3.239610	178.00	141	9.306450	473.50
32	-6.103700	33.30	87	-3.122930	182.00	142	9.706830	481.00
33	-6.090300	34.80	88	-3.004370	186.00	143	10.1103	488.50
34	-6.075460	36.40	89	-2.884040	190.00	144	10.5169	496.00
35	-6.060040	38.00	90	-2.761910	194.00	145	10.9264	503.50
36	-6.044070	39.60	91	-2.638010	198.00	146	11.3664	511.50
37	-6.025470	41.40	92	-2.512340	202.00	147	11.8098	519.50
38	-6.006200	43.20	93	-2.384920	206.00	148	12.2564	527.50
39	-5.986280	45.00	94	-2.255770	210.00	149	12.7342	536.00
40	-5.965730	46.80	95	-2.124900	214.00	150	13.2155	544.50
41	-5.942210	48.80	96	-1.992320	218.00	151	13.7	553.00
42	-5.917930	50.80	97	-1.858060	222.00	152	14.1879	561.50
43	-5.892970	52.80	98	-1.705090	226.50	153	14.7079	570.50
44	-5.864730	55.00	99	-1.549970	231.00	154	15.2314	579.50
45	-5.835680	57.20	100	-1.392820	235.50	155	15.7583	588.50
46	-5.805860	59.40	101	-1.233640	240.00	156	16.2887	597.50
47	-5.776670	61.50	102	-1.072450	244.50	157	16.8224	606.50
48	-5.741100	64.00	103	-0.909257	249.00	158	17.3594	615.50
49	-5.704560	66.50	104	-0.744065	253.50	159	17.9297	625.00
50	-5.667130	69.00	105	-0.576893	258.00	160	18.5037	634.50
51	-5.628800	71.50	106	-0.407776	262.50	161	19.1116	644.50
52	-5.589590	74.00	107	-0.217705	267.50	162	19.7538	655.00
53	-5.549510	76.50	108	-0.025325	272.50	163	20.4611	666.50
54	-5.508560	79.00	109	0.188573	278.00	164	20.8627	673.00
55	-5.466760	81.50	110	0.404639	283.50			



**Table D-10. Chromel-AuFe0.03% Thermocouple Curve \***

Breakpoint	mV	Temp (K)	Breakpoint	mV	Temp (K)
1	-4.6667	3.5	32	-2.24537	160
2	-4.62838	6.35	33	-2.06041	170
3	-4.60347	8.15	34	-1.86182	180.5
4	-4.58043	9.75	35	-1.66004	191
5	-4.53965	12.5	36	-1.47556	200.5
6	-4.47226	16.95	37	-1.0904	220
7	-4.43743	19.3	38	-0.73397	237.5
8	-4.39529	22.2	39	-0.68333	240
9	-4.34147	26	40	-0.3517	256
10	-4.29859	29.1	41	-0.2385	261.5
11	-4.26887	31.3	42	0.078749	277
12	-4.22608	34.5	43	0.139668	280
13	-4.2018	36.3	44	0.426646	294.5
14	-4.02151	49.8	45	0.546628	300.5
15	-3.94549	55.4	46	0.858608	316
16	-3.87498	60.5	47	0.938667	320
17	-3.80464	65.5	48	1.3456	340
18	-3.73301	70.5	49	1.7279	358.5
19	-3.65274	76	50	1.76905	360.5
20	-3.5937	80	51	2.20705	381.5
21	-3.51113	85.5	52	2.51124	396
22	-3.45023	89.5	53	2.69878	405
23	-3.43451	90.5	54	2.94808	417
24	-3.37842	94	55	3.13562	426
25	-3.35469	95.5	56	3.43707	440.5
26	-3.28237	100	57	3.85513	460.5
27	-3.11919	110	58	4.17136	475.5
28	-2.95269	120	59	4.28662	481
29	-2.78168	130	60	4.64037	498
30	-2.60639	140	61	4.68168	500
31	-2.42737	150			

\* This thermocouple is no longer sold by Lake Shore.

Table D-11. Chromel-AuFe0.07% Thermocouple Curve

Break-point	mV	Temp (K)	Break-point	mV	Temp (K)	Break-point	mV	Temp (K)
1	-5.279520	3.15	35	-3.340820	115.00	69	1.313400	332.50
2	-5.272030	3.78	36	-3.253410	119.50	70	1.511140	341.50
3	-5.263500	4.46	37	-3.165360	124.00	71	1.709250	350.50
4	-5.253730	5.20	38	-3.076690	128.50	72	1.928940	360.50
5	-5.242690	6.00	39	-2.977480	133.50	73	2.127070	369.50
6	-5.229730	6.90	40	-2.877550	138.50	74	2.324710	378.50
7	-5.214770	7.90	41	-2.776950	143.50	75	2.523070	387.50
8	-5.196980	9.05	42	-2.675700	148.50	76	2.643480	393.00
9	-5.176250	10.35	43	-2.563610	154.00	77	2.708890	396.00
10	-5.150910	11.90	44	-2.450770	159.50	78	2.764030	398.50
11	-5.116700	13.95	45	-2.337230	165.00	79	2.797580	400.00
12	-5.049770	17.90	46	-2.223010	170.50	80	2.950200	406.50
13	-5.002120	20.70	47	-2.097700	176.50	81	3.008310	409.00
14	-4.938000	24.50	48	-1.971630	182.50	82	3.031200	410.00
15	-4.876180	28.20	49	-1.844890	188.50	83	3.218040	418.00
16	-4.801670	32.70	50	-1.706840	195.00	84	3.300110	421.50
17	-4.648620	42.00	51	-1.568040	201.50	85	4.000810	451.50
18	-4.569170	46.80	52	-1.428520	208.00	86	4.246390	462.00
19	-4.499080	51.00	53	-1.277520	215.00	87	4.701810	481.50
20	-4.435090	54.80	54	-1.114900	222.50	88	4.947390	492.00
21	-4.370520	58.60	55	-0.940599	230.50	89	5.636410	521.50
22	-4.303610	62.50	56	-0.754604	239.00	90	5.870300	531.50
23	-4.234290	66.50	57	-0.556906	248.00	91	6.547630	560.50
24	-4.164270	70.50	58	-0.358437	257.00	92	6.711600	567.50
25	-4.093560	74.50	59	-0.170179	265.50	93	6.781410	570.50
26	-4.022170	78.50	60	0.041150	275.00	94	6.931500	577.00
27	-3.950100	82.50	61	0.152699	280.00	95	7.001360	580.00
28	-3.877360	86.50	62	0.163149	280.50	96	7.166710	587.00
29	-3.803960	90.50	63	0.374937	290.00	97	7.260420	591.00
30	-3.729910	94.50	64	0.542973	297.50	98	7.412010	597.50
31	-3.655230	98.50	65	0.598604	300.00	99	7.529070	602.50
32	-3.579930	102.50	66	0.774384	308.00	100	7.657460	608.00
33	-3.504020	106.50	67	0.840638	311.00	101	7.704410	610.00
34	-3.427530	110.50	68	1.126350	324.00			