



4-Pin μ P Voltage Monitors with Manual Reset Input

MAX811/MAX812

General Description

The MAX811/MAX812 are low-power microprocessor (μ P) supervisory circuits used to monitor power supplies in μ P and digital systems. They provide excellent circuit reliability and low cost by eliminating external components and adjustments when used with 5V-powered or 3V-powered circuits. The MAX811/MAX812 also provide a debounced manual reset input.

These devices perform a single function: They assert a reset signal whenever the V_{CC} supply voltage falls below a preset threshold, keeping it asserted for at least 140ms after V_{CC} has risen above the reset threshold. The only difference between the two devices is that the MAX811 has an active-low $\overline{\text{RESET}}$ output (which is guaranteed to be in the correct state for V_{CC} down to 1V), while the MAX812 has an active-high RESET output. The reset comparator is designed to ignore fast transients on V_{CC} . Reset thresholds are available for operation with a variety of supply voltages.

Low supply current makes the MAX811/MAX812 ideal for use in portable equipment. The devices come in a 4-pin SOT143 package.

Applications

Computers
Controllers
Intelligent Instruments
Critical μ P and μ C Power Monitoring
Portable/Battery-Powered Equipment

Typical Operating Circuit

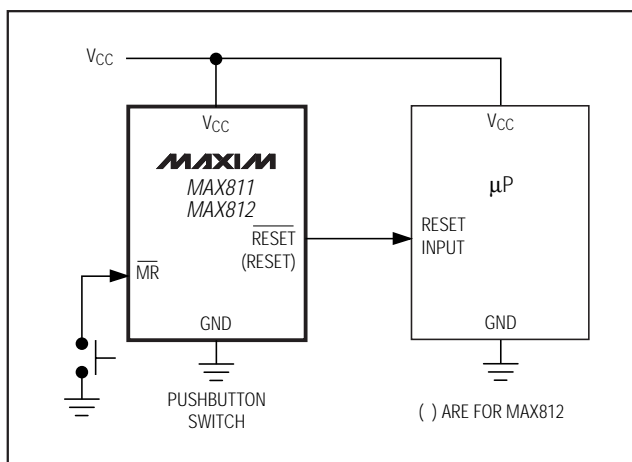

Features

- ◆ Precision Monitoring of 3V, 3.3V, and 5V Power-Supply Voltages
- ◆ 6 μ A Supply Current
- ◆ 140ms Min Power-On Reset Pulse Width; $\overline{\text{RESET}}$ Output (MAX811), RESET Output (MAX812)
- ◆ Guaranteed Over Temperature
- ◆ Guaranteed $\overline{\text{RESET}}$ Valid to $V_{CC} = 1\text{V}$ (MAX811)
- ◆ Power-Supply Transient Immunity
- ◆ No External Components
- ◆ 4-Pin SOT143 Package

Ordering Information

PART*	TEMP. RANGE	PIN-PACKAGE
MAX811_EUS-T	-40°C to +85°C	4 SOT143
MAX812_EUS-T	-40°C to +85°C	4 SOT143

* This part offers a choice of five different reset threshold voltages. Select the letter corresponding to the desired nominal reset threshold voltage, and insert it into the blank to complete the part number.

RESET THRESHOLD	
SUFFIX	VOLTAGE (V)
L	4.63
M	4.38
T	3.08
S	2.93
R	2.63

Pin Configuration

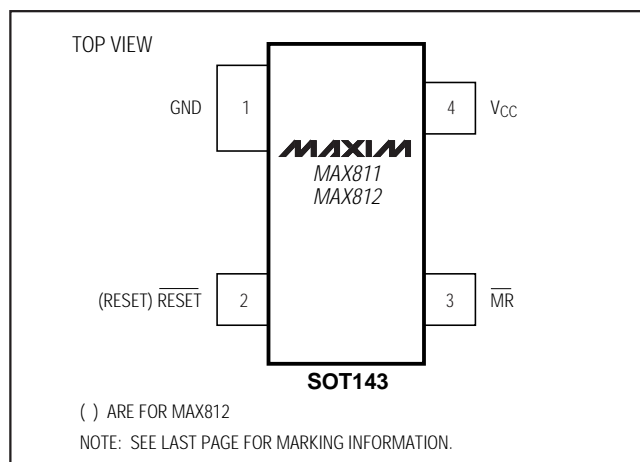

Maxim Integrated Products 1

For free samples & the latest literature: <http://www.maxim-ic.com>, or phone 1-800-998-8800.
For small orders, phone 408-737-7600 ext. 3468.

4-Pin μ P Voltage Monitors with Manual Reset Input

ABSOLUTE MAXIMUM RATINGS

Terminal Voltage (with respect to GND)

V _{CC}	-0.3V to 6.0V
All Other Inputs	-0.3V to (V _{CC} + 0.3V)
Input Current, V _{CC} , $\overline{\text{MR}}$	20mA
Output Current, RESET or $\overline{\text{RESET}}$	20mA

Continuous Power Dissipation (T_A = +70°C)

SOT143 (derate 4mW/°C above +70°C)	320mW
Operating Temperature Range	-40°C to +85°C
Storage Temperature Range	-65°C to +160°C
Lead Temperature (soldering, 10sec)	+300°C

Stresses beyond those listed under "Absolute Maximum Ratings" may cause permanent damage to the device. These are stress ratings only, and functional operation of the device at these or any other conditions beyond those indicated in the operational sections of the specifications is not implied. Exposure to absolute maximum rating conditions for extended periods may affect device reliability.

ELECTRICAL CHARACTERISTICS

(V_{CC} = 5V for L/M versions, V_{CC} = 3.3V for T/S versions, V_{CC} = 3V for R version, T_A = -40°C to +85°C, unless otherwise noted. Typical values are at T_A = +25°C.) (Note 1)

PARAMETER	SYMBOL	CONDITIONS	MIN	TYP	MAX	UNITS			
Operating Voltage Range	V _{CC}	T _A = 0°C to +70°C	1.0		5.5	V			
		T _A = -40°C to +85°C	1.2						
Supply Current	I _{CC}	MAX81_L/M, V _{CC} = 5.5V, I _{OUT} = 0		6	15	μ A			
		MAX81_R/S/T, V _{CC} = 3.6V, I _{OUT} = 0		2.7	10				
Reset Threshold	V _{TH}	MAX81_L	T _A = +25°C	4.54	4.63	4.72	V		
			T _A = -40°C to +85°C	4.50		4.75			
		MAX81_M	T _A = +25°C	4.30	4.38	4.46			
			T _A = -40°C to +85°C	4.25		4.50			
		MAX81_T	T _A = +25°C	3.03	3.08	3.14			
			T _A = -40°C to +85°C	3.00		3.15			
		MAX81_S	T _A = +25°C	2.88	2.93	2.98			
			T _A = -40°C to +85°C	2.85		3.00			
		MAX81_R	T _A = +25°C	2.58	2.63	2.68			
			T _A = -40°C to +85°C	2.55		2.70			
		Reset Threshold Tempco				30			ppm/°C
		V _{CC} to Reset Delay (Note 2)		V _{OD} = 125mV, MAX81_L/M		40			μ s
V _{OD} = 125mV, MAX81_R/S/T				20					
Reset Active Timeout Period	t _{RP}	V _{CC} = V _{TH} (MAX)	140		560	ms			
$\overline{\text{MR}}$ Minimum Pulse Width	t _{MR}		10			μ s			
$\overline{\text{MR}}$ Glitch Immunity (Note 3)				100		ns			
$\overline{\text{MR}}$ to Reset Propagation Delay (Note 2)	t _{MD}			0.5		μ s			
$\overline{\text{MR}}$ Input Threshold	V _{IH}	V _{CC} > V _{TH} (MAX), MAX81_L/M	2.3		V				
	V _{IL}		0.8						
	V _{IH}	V _{CC} > V _{TH} (MAX), MAX81_R/S/T	0.7 x V _{CC}						
	V _{IL}		0.25 x V _{CC}						
$\overline{\text{MR}}$ Pull-Up Resistance			10	20	30	k Ω			
RESET Output Voltage (MAX812)	V _{OH}	I _{SOURCE} = 150 μ A, 1.8V < V _{CC} < V _{TH} (MIN)	0.8V _{CC}		V				
	V _{OL}	MAX812R/S/T only, I _{SINK} = 1.2mA, V _{CC} = V _{TH} (MAX)	0.3						
		MAX812L/M only, I _{SINK} = 3.2mA, V _{CC} = V _{TH} (MAX)	0.4						

4-Pin μP Voltage Monitors with Manual Reset Input

MAX811/MAX812

ELECTRICAL CHARACTERISTICS (continued)

($V_{CC} = 5V$ for L/M versions, $V_{CC} = 3.3V$ for T/S versions, $V_{CC} = 3V$ for R version, $T_A = -40^{\circ}C$ to $+85^{\circ}C$, unless otherwise noted. Typical values are at $T_A = +25^{\circ}C$.) (Note 1)

PARAMETER	SYMBOL	CONDITIONS	MIN	TYP	MAX	UNITS
RESET Output Voltage (MAX811)	VOL	MAX811R/S/T only, $I_{SINK} = 1.2mA$, $V_{CC} = V_{TH(MIN)}$			0.3	V
		MAX811L/M only, $I_{SINK} = 3.2mA$, $V_{CC} = V_{TH(MIN)}$			0.4	
		$I_{SINK} = 50\mu A$, $V_{CC} > 1.0V$			0.3	
	VOH	MAX811R/S/T only, $I_{SOURCE} = 500\mu A$, $V_{CC} > V_{TH(MAX)}$	0.8V _{CC}			
		MAX811L/M only, $I_{SOURCE} = 800\mu A$, $V_{CC} > V_{TH(MAX)}$	V _{CC} - 1.5			

Note 1: Production testing done at $T_A = +25^{\circ}C$, over temperature limits guaranteed by design using six sigma design limits.

Note 2: RESET output for MAX811, RESET output for MAX812.

Note 3: "Glitches" of 100ns or less typically will not generate a reset pulse.

4-Pin μP Voltage Monitors with Manual Reset Input

Typical Operating Characteristics

($T_A = +25^\circ C$, unless otherwise noted.)

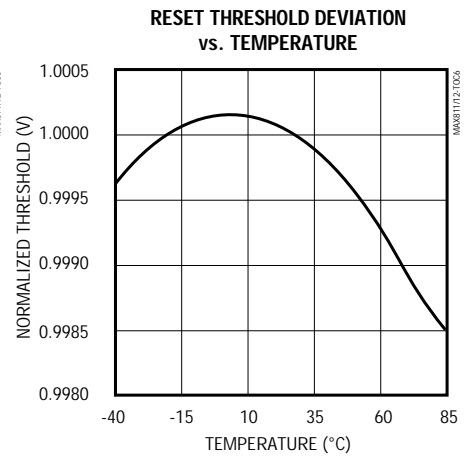
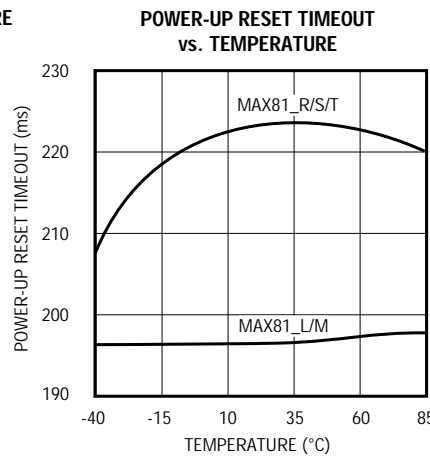
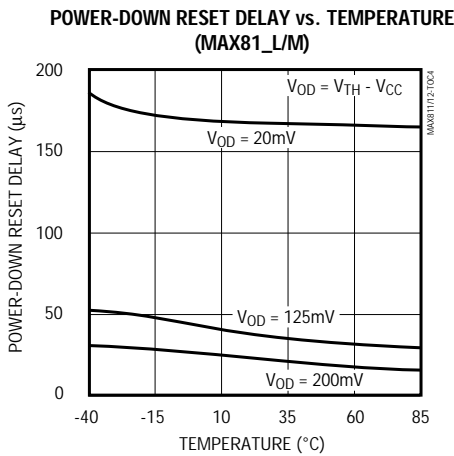
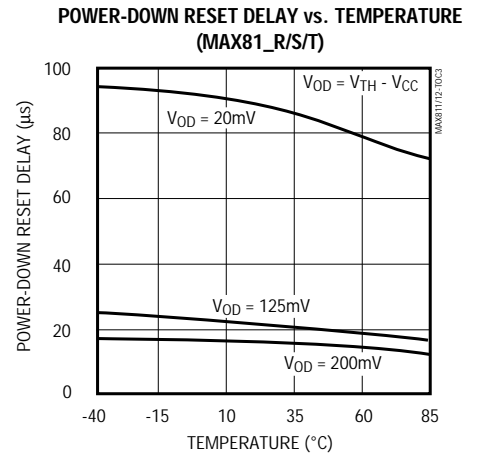
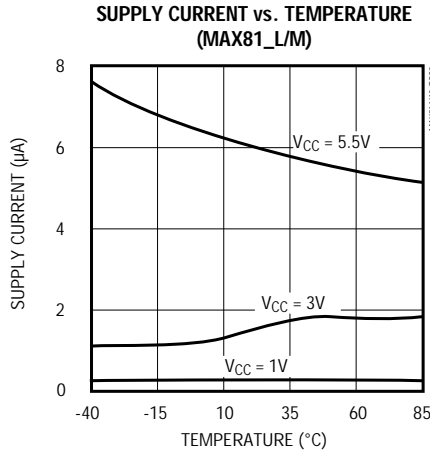
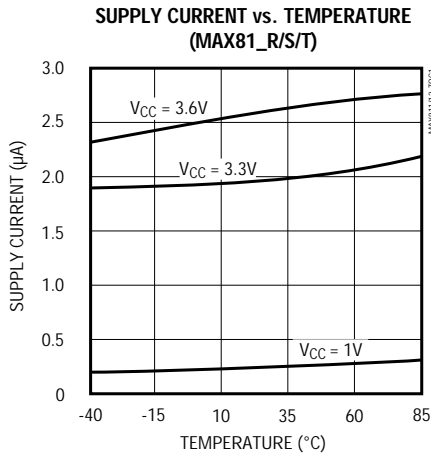

4-Pin μ P Voltage Monitors with Manual Reset Input

Pin Description

MAX811/MAX812

PIN		NAME	FUNCTION
MAX811	MAX812		
1	1	GND	Ground
2	—	$\overline{\text{RESET}}$	Active-Low Reset Output. $\overline{\text{RESET}}$ remains low while V_{CC} is below the reset threshold or while $\overline{\text{MR}}$ is held low. $\overline{\text{RESET}}$ remains low for the Reset Active Timeout Period (t_{RP}) after the reset conditions are terminated.
—	2	RESET	Active-High Reset Output. RESET remains high while V_{CC} is below the reset threshold or while $\overline{\text{MR}}$ is held low. RESET remains high for Reset Active Timeout Period (t_{RP}) after the reset conditions are terminated.
3	3	$\overline{\text{MR}}$	Manual Reset Input. A logic low on $\overline{\text{MR}}$ asserts reset. Reset remains asserted as long as $\overline{\text{MR}}$ is low and for 180ms after $\overline{\text{MR}}$ returns high. This active-low input has an internal 20k Ω pull-up resistor. It can be driven from a TTL or CMOS-logic line, or shorted to ground with a switch. Leave open if unused.
4	4	VCC	+5V, +3.3V, or +3V Supply Voltage

Detailed Description

Reset Output

A microprocessor's (μ P's) reset input starts the μ P in a known state. These μ P supervisory circuits assert reset to prevent code execution errors during power-up, power-down, or brownout conditions.

$\overline{\text{RESET}}$ is guaranteed to be a logic low for $V_{CC} > 1V$. Once V_{CC} exceeds the reset threshold, an internal timer keeps $\overline{\text{RESET}}$ low for the reset timeout period; after this interval, $\overline{\text{RESET}}$ goes high.

If a brownout condition occurs (V_{CC} dips below the reset threshold), $\overline{\text{RESET}}$ goes low. Any time V_{CC} goes below the reset threshold, the internal timer resets to zero, and $\overline{\text{RESET}}$ goes low. The internal timer starts after V_{CC} returns above the reset threshold, and $\overline{\text{RESET}}$ remains low for the reset timeout period.

The manual reset input ($\overline{\text{MR}}$) can also initiate a reset. See the *Manual Reset Input* section.

The MAX812 has an active-high RESET output that is the inverse of the MAX811's $\overline{\text{RESET}}$ output.

Manual Reset Input

Many μ P-based products require manual reset capability, allowing the operator, a test technician, or external logic circuitry to initiate a reset. A logic low on $\overline{\text{MR}}$ asserts reset. Reset remains asserted while $\overline{\text{MR}}$ is low, and for the Reset Active Timeout Period (t_{RP}) after $\overline{\text{MR}}$ returns high. This input has an internal 20k Ω pull-up resistor, so it can be left open if it is not used. $\overline{\text{MR}}$ can be driven with TTL or CMOS-logic levels, or with open-drain/collector outputs. Connect a normally open momentary switch from $\overline{\text{MR}}$ to GND to create a manual-reset function; external debounce circuitry is not required. If $\overline{\text{MR}}$ is driven from long cables or if the device is used in a noisy environment, connecting a 0.1 μ F capacitor from $\overline{\text{MR}}$ to ground provides additional noise immunity.

Reset Threshold Accuracy

The MAX811/MAX812 are ideal for systems using a 5V \pm 5% or 3V \pm 5% power supply with ICs specified for 5V \pm 10% or 3V \pm 10%, respectively. They are designed to meet worst-case specifications over temperature. The reset is guaranteed to assert after the power supply falls out of regulation, but before power drops below the minimum specified operating voltage range for the system ICs. The thresholds are pre-trimmed and exhibit tight distribution, reducing the range over which an undesirable reset may occur.

4-Pin μP Voltage Monitors with Manual Reset Input

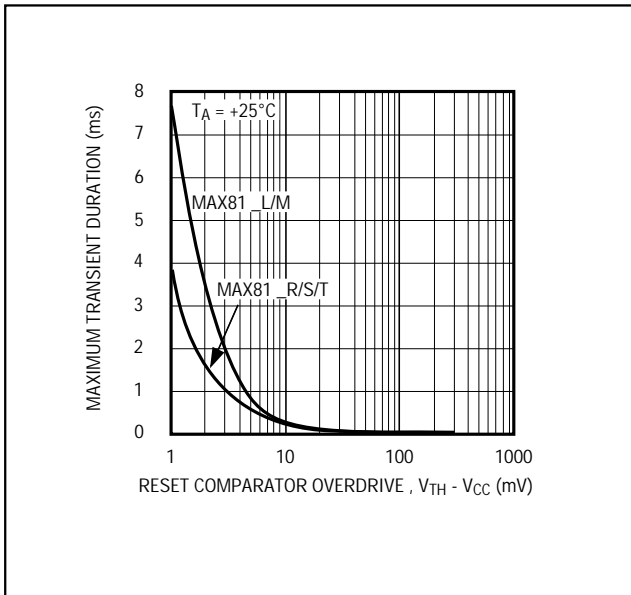

Figure 1. Maximum Transient Duration without Causing a Reset Pulse vs. Comparator Overdrive

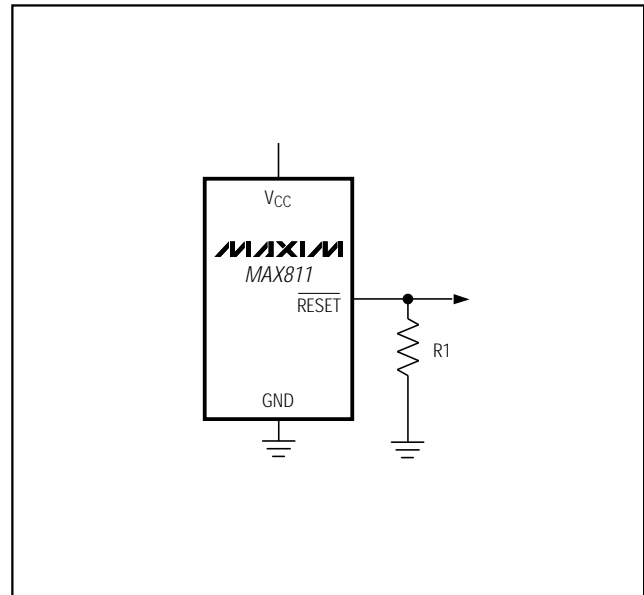

Figure 2. $\overline{\text{RESET}}$ Valid to $V_{CC} = \text{Ground}$ Circuit

Applications Information

Negative-Going V_{CC} Transients

In addition to issuing a reset to the μP during power-up, power-down, and brownout conditions, the MAX811/MAX812 are relatively immune to short duration negative-going V_{CC} transients (glitches).

Figure 1 shows typical transient durations vs. reset comparator overdrive, for which the MAX811/MAX812 do not generate a reset pulse. This graph was generated using a negative-going pulse applied to V_{CC} , starting above the actual reset threshold and ending below it by the magnitude indicated (reset comparator overdrive). The graph indicates the typical maximum pulse width a negative-going V_{CC} transient may have without causing a reset pulse to be issued. As the magnitude of the transient increases (goes farther below the reset threshold), the maximum allowable pulse width decreases. Typically, a V_{CC} transient that goes 125mV below the reset threshold and lasts 40 μs or less (MAX811_L/M) or 20 μs or less (MAX811_T/S/R) will not cause a reset pulse to be issued. A 0.1 μF capacitor mounted as close as possible to V_{CC} provides additional transient immunity.

Ensuring a Valid $\overline{\text{RESET}}$ Output Down to $V_{CC} = 0\text{V}$

When V_{CC} falls below 1V, the MAX811 $\overline{\text{RESET}}$ output no longer sinks current—it becomes an open circuit. Therefore, high-impedance CMOS-logic inputs connected to the $\overline{\text{RESET}}$ output can drift to undetermined voltages. This presents no problem in most applications, since most μP and other circuitry is inoperative with V_{CC} below 1V. However, in applications where the $\overline{\text{RESET}}$ output must be valid down to 0V, adding a pull-down resistor to the $\overline{\text{RESET}}$ pin will cause any stray leakage currents to flow to ground, holding $\overline{\text{RESET}}$ low (Figure 2). R1's value is not critical; 100k Ω is large enough not to load $\overline{\text{RESET}}$ and small enough to pull $\overline{\text{RESET}}$ to ground.

A 100k Ω pull-up resistor to V_{CC} is also recommended for the MAX812 if $\overline{\text{RESET}}$ is required to remain valid for $V_{CC} < 1\text{V}$.

4-Pin μP Voltage Monitors with Manual Reset Input

MAX811/MAX812

Interfacing to μP s with Bidirectional Reset Pins

μP s with bidirectional reset pins (such as the Motorola 68HC11 series) can contend with the MAX811/MAX812 reset outputs. If, for example, the MAX811 $\overline{\text{RESET}}$ output is asserted high and the μP wants to pull it low, indeterminate logic levels may result. To correct such cases, connect a $4.7k\Omega$ resistor between the MAX811 $\overline{\text{RESET}}$ (or MAX812 $\overline{\text{RESET}}$) output and the μP reset I/O (Figure 3). Buffer the reset output to other system components.

Chip Information

TRANSISTOR COUNT: 341

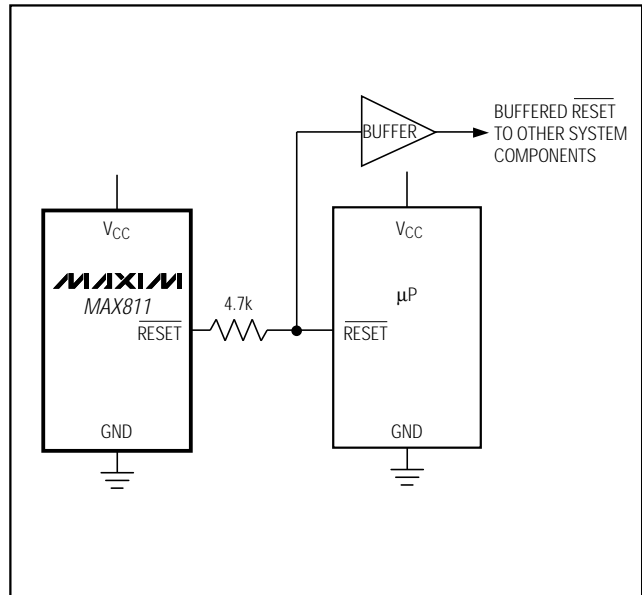
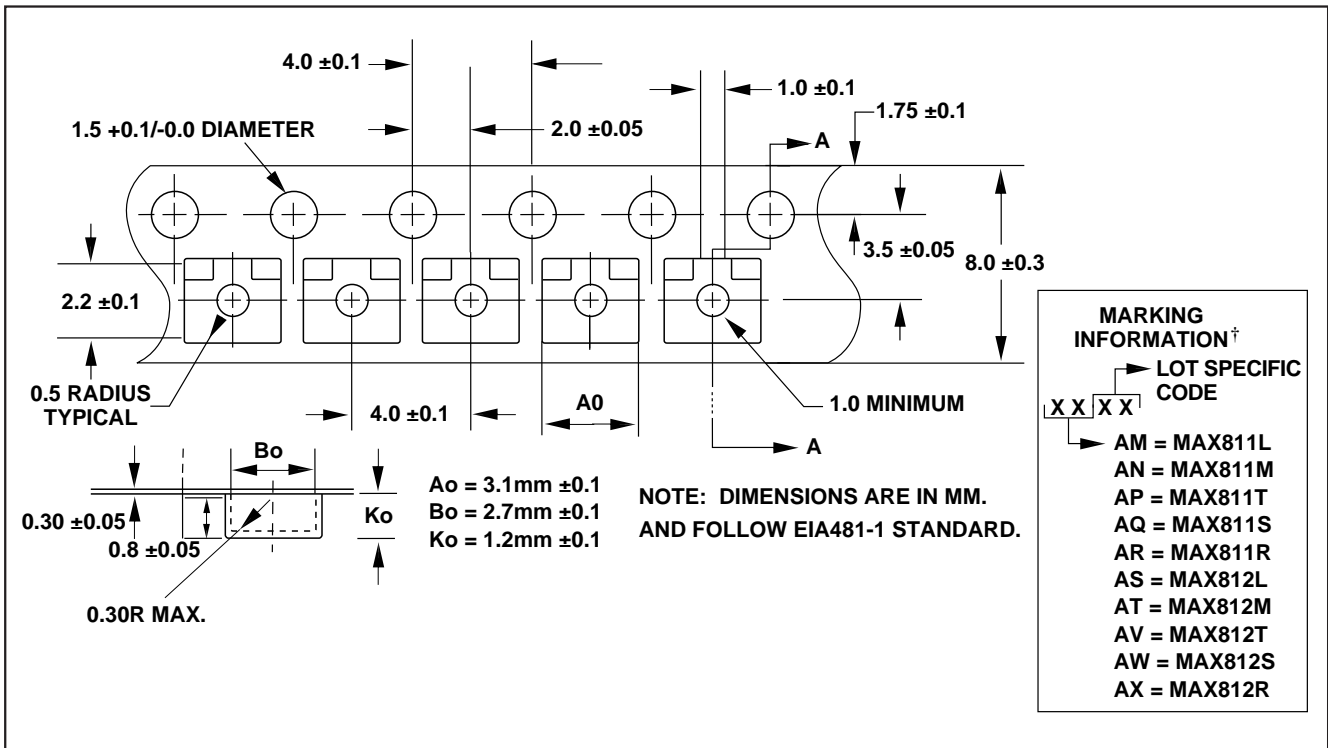

Figure 3. Interfacing to μP s with Bidirectional Reset I/O

Tape-and-Reel Information



4-Pin μ P Voltage Monitors with Manual Reset Input

Package Information

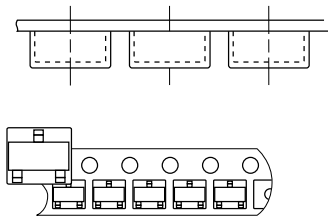
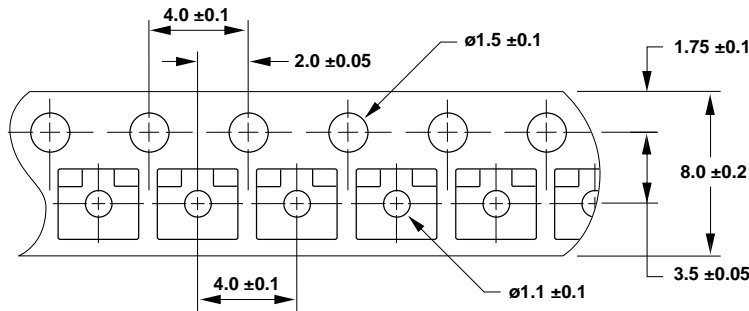

NOTE: DIMENSIONS ARE IN MM.
AND FOLLOW EIA481-1 STANDARD.

MARKING INFORMATION [†]	
X X	LOT SPECIFIC CODE
AM	MAX811L
AN	MAX811M
AP	MAX811T
AQ	MAX811S
AR	MAX811R
AS	MAX812L
AT	MAX812M
AV	MAX812T
AW	MAX812S
AX	MAX812R

[†] ICs MAY ALSO BE MARKED WITH FULL PART NAME: 811L, 811M...

DIM	INCHES		MILLIMETERS	
	MIN	MAX	MIN	MAX
A	0.031	0.047	0.787	1.194
A1	0.001	0.005	0.025	0.127
B	0.014	0.022	0.356	0.559
B1	0.030	0.038	0.762	0.965
C	0.0034	0.006	0.086	0.152
D	0.105	0.120	2.667	3.048
E	0.047	0.055	1.194	1.397
e1	0.071	0.079	1.803	2.007
e2	0.008 BSC		0.200 BSC	
H	0.082	0.098	2.083	2.489
I	0.004	0.012	0.102	0.305
S	0.018	0.024	0.450	0.600
α	0°	8°	0°	8°

NOTES:
 1. D&E DO NOT INCLUDE MOLD FLASH.
 2. MOLD FLASH OR PROTRUSIONS NOT TO EXCEED .15mm (.006")
 3. CONTROLLING DIMENSION: MILLIMETER

PROPRIETARY INFORMATION
 TITLE: PACKAGE OUTLINE_SOT-143, 4L
 APPROVAL: _____ DOCUMENT CONTROL NO. 21-0052 REV C 1/1

cannot assume responsibility for use of any circuitry other than circuitry entirely embodied in a Maxim product. No circuit patent licenses are implied. Maxim reserves the right to change the circuitry and specifications without notice at any time.